

Oracle® Database

Java Developer's Guide



19c
E96468-01
January 2019



Oracle Database Java Developer's Guide, 19c

E96468-01

Copyright © 1999, 2019, Oracle and/or its affiliates. All rights reserved.

Primary Author: Tulika Das

Contributors: Sheryl Maring, Rick Sapir, Michael Wiesenber, Venkatasubramaniam Iyer, Brian Wright, Timothy Smith, Malik Kafane

Contributing Authors: Tanmay Choudhury, Kuassi Mensah, Mark Jungerman, Suresh Srinivasan, Ernest Tucker, Robert H Lee, Dmitry Nizhegorodov, Nataraju Neeluru, David Unietis, Paul Lo, Steve Harris, Ellen Barnes, Peter Benson, Greg Colvin, Bill Courington, Matthieu Devin, Jim Haungs, Hal Hildebrand, Susan Kraft, Thomas Kurian, Scott Meyer, Tom Portfolio, Dave Rosenberg, Jerry Schwarz, Harlan Sexton, Xuhua Li

This software and related documentation are provided under a license agreement containing restrictions on use and disclosure and are protected by intellectual property laws. Except as expressly permitted in your license agreement or allowed by law, you may not use, copy, reproduce, translate, broadcast, modify, license, transmit, distribute, exhibit, perform, publish, or display any part, in any form, or by any means. Reverse engineering, disassembly, or decompilation of this software, unless required by law for interoperability, is prohibited.

The information contained herein is subject to change without notice and is not warranted to be error-free. If you find any errors, please report them to us in writing.

If this is software or related documentation that is delivered to the U.S. Government or anyone licensing it on behalf of the U.S. Government, then the following notice is applicable:

U.S. GOVERNMENT END USERS: Oracle programs, including any operating system, integrated software, any programs installed on the hardware, and/or documentation, delivered to U.S. Government end users are "commercial computer software" pursuant to the applicable Federal Acquisition Regulation and agency-specific supplemental regulations. As such, use, duplication, disclosure, modification, and adaptation of the programs, including any operating system, integrated software, any programs installed on the hardware, and/or documentation, shall be subject to license terms and license restrictions applicable to the programs. No other rights are granted to the U.S. Government.

This software or hardware is developed for general use in a variety of information management applications. It is not developed or intended for use in any inherently dangerous applications, including applications that may create a risk of personal injury. If you use this software or hardware in dangerous applications, then you shall be responsible to take all appropriate fail-safe, backup, redundancy, and other measures to ensure its safe use. Oracle Corporation and its affiliates disclaim any liability for any damages caused by use of this software or hardware in dangerous applications.

Oracle and Java are registered trademarks of Oracle and/or its affiliates. Other names may be trademarks of their respective owners.

Intel and Intel Xeon are trademarks or registered trademarks of Intel Corporation. All SPARC trademarks are used under license and are trademarks or registered trademarks of SPARC International, Inc. AMD, Opteron, the AMD logo, and the AMD Opteron logo are trademarks or registered trademarks of Advanced Micro Devices. UNIX is a registered trademark of The Open Group.

This software or hardware and documentation may provide access to or information about content, products, and services from third parties. Oracle Corporation and its affiliates are not responsible for and expressly disclaim all warranties of any kind with respect to third-party content, products, and services unless otherwise set forth in an applicable agreement between you and Oracle. Oracle Corporation and its affiliates will not be responsible for any loss, costs, or damages incurred due to your access to or use of third-party content, products, or services, except as set forth in an applicable agreement between you and Oracle.

Contents

Preface

Audience	xv
Documentation Accessibility	xv
Related Documents	xv
Conventions	xvi

Changes in This Release for Oracle Database Java Developer's Guide

Changes in Oracle Database 19c	xvii
--------------------------------	------

1 Introduction to Java in Oracle Database

1.1 Overview of Java	1-1
1.1.1 Java and Object-Oriented Programming Terminology	1-1
1.1.1.1 Classes	1-2
1.1.1.2 Objects	1-2
1.1.1.3 Inheritance	1-3
1.1.1.4 Interfaces	1-3
1.1.1.5 Encapsulation	1-4
1.1.1.6 Polymorphism	1-4
1.1.2 Key Features of the Java Language	1-5
1.1.3 Java Virtual Machine	1-6
1.1.4 Java Class Hierarchy	1-8
1.2 About Using Java in Oracle Database	1-9
1.2.1 Java and RDBMS: A Robust Combination	1-9
1.2.2 About Multithreading	1-10
1.2.3 Memory Spaces Management	1-11
1.2.4 Footprint	1-12
1.2.5 Performance of an Oracle JVM	1-13
1.2.6 Dynamic Class Loading	1-15
1.3 Overview of Oracle JVM	1-15
1.3.1 Process Area	1-16

1.3.2	Java session initialization, duration and entrypoints	1-16
1.3.3	The GUI	1-17
1.3.4	The IDE	1-17
1.4	Feature List of Oracle JVM	1-17
1.5	Main Components of Oracle JVM	1-18
1.5.1	Library Manager	1-19
1.5.2	Compiler	1-20
1.5.3	Interpreter	1-20
1.5.4	Class Loader	1-20
1.5.5	Verifier	1-20
1.5.6	Server-Side JDBC Internal Driver	1-20
1.5.7	Server-Side SQLJ Translator	1-21
1.5.8	System Classes	1-21
1.6	Java Programming in Oracle Database	1-21
1.6.1	Java in Database Application Development	1-22
1.6.2	Java Programming Environment Usage	1-22
1.6.3	Java Stored Procedures	1-22
1.6.4	PL/SQL Integration and Oracle RDBMS Functionality	1-23
1.6.4.1	JDBC Drivers	1-23
1.6.4.2	SQLJ	1-24
1.6.5	Development Tools	1-24
1.6.6	Internet Protocol Version 6 Support	1-24
1.7	Support for Java 8	1-25
1.8	Memory Model for Dedicated Mode Sessions	1-25

2 Java Applications on Oracle Database

2.1	Database Sessions Imposed on Java Applications	2-1
2.2	Execution Control of Java Applications	2-3
2.3	Java Code, Binaries, and Resources Storage	2-3
2.4	About Java Classes Loaded in the Database	2-4
2.5	Preparing Java Class Methods for Execution	2-5
2.5.1	Compiling Java Classes	2-6
2.5.1.1	Compiling Source Through javac	2-7
2.5.1.2	Compiling Source Through the loadjava Tool	2-7
2.5.1.3	Compiling Source at Run Time	2-7
2.5.1.4	Specifying Compiler Options	2-7
2.5.1.5	Recompiling Source Programs Automatically	2-10
2.5.2	Overview of Resolving Class Dependencies	2-11
2.5.2.1	Allowing References to Nonexistent Classes	2-12
2.5.2.2	Bytecode Verifier	2-13

2.5.3	Logging in Oracle JVM	2-14
2.5.4	Overview of Loading Classes Using the loadjava Tool	2-15
2.5.4.1	About Sharing of Metadata for User Classloaded Classes	2-17
2.5.4.2	Defining the Same Class Twice	2-17
2.5.4.3	About Designating Database Privileges and JVM Permissions	2-18
2.5.4.4	About Loading JAR or ZIP Files	2-18
2.5.4.5	Database Resident JARs	2-19
2.5.5	Overview of Granting Execute Rights	2-19
2.5.6	Overview of Controlling the Current User	2-20
2.5.7	Overview of Checking Java Uploads	2-22
2.5.8	About Publishing Java Methods Loaded in the Database	2-24
2.5.9	Overview of Auditing Java Classes Loaded in the Database	2-24
2.6	User Interfaces on the Server	2-25
2.7	Shortened Class Names	2-26
2.8	Class.forName() in Oracle Database	2-27
2.8.1	Supply ClassLoader in Class.forName()	2-28
2.8.2	Supply Class and Schema Names to classForNameAndSchema()	2-29
2.8.3	Supply Class and Schema Names to lookupClass()	2-29
2.8.4	Supply Class and Schema Names when Serializing	2-30
2.8.5	Class.forName Example	2-30
2.9	About Managing Your Operating System Resources	2-31
2.9.1	Overview of Operating System Resources	2-31
2.9.2	Garbage Collection and Operating System Resources	2-32
2.10	About Using the Runtime.exec Functionality in Oracle Database	2-33
2.11	Managing Your Applications Using JMX	2-33
2.11.1	Overview of JMX	2-34
2.11.2	Enabling and Starting JMX in a Session	2-34
2.11.3	Setting Oracle JVM JMX Defaults and Configurability	2-35
2.11.4	Examples of SQL calls to dbms_java.start_jmx_agent	2-36
2.11.5	Using JConsole to Monitor and Control Oracle JVM	2-37
2.11.5.1	Using the jconsole Command	2-38
2.11.5.2	About Using the JConsole interface	2-38
2.11.5.3	About Viewing Oracle JVM Summary Information	2-39
2.11.5.4	About Monitoring Memory Consumption	2-40
2.11.5.5	About Monitoring Thread Use	2-42
2.11.5.6	About Monitoring Class Loading	2-43
2.11.5.7	About Monitoring and Managing MBeans	2-44
2.11.5.8	About Viewing VM Information	2-47
2.11.5.9	The OracleRuntime MBean	2-48
2.11.5.10	Memory Thresholds	2-51
2.11.6	Important Security Notes	2-53

2.11.7	Shared Server Limitations for JMX	2-53
2.12	Overview of Threading in Oracle Database	2-54
2.12.1	Thread Life Cycle	2-55
2.12.2	System.exit(), OracleRuntime.exitSession(), and OracleRuntime.exitCall()	2-56
2.13	Shared Servers Considerations	2-57
2.13.1	End-of-Call Migration	2-57
2.13.2	Oracle-Specific Support for End-of-Call Optimization	2-58
2.13.3	The EndOfCallRegistry.registerCallback() Method	2-61
2.13.4	The EndOfCallRegistry.runCallbacks() Method	2-61
2.13.5	The Callback Interface	2-62
2.13.6	The Callback.act() method	2-62
2.13.7	Operating System Resources Affected Across Calls	2-62

3 Calling Java Methods in Oracle Database

3.1	Invoking Java Methods	3-1
3.1.1	Using PL/SQL Wrappers	3-1
3.1.2	About JNI Support	3-3
3.1.3	About Utilizing SQLJ and JDBC with Java in the Database	3-3
3.1.3.1	Using JDBC	3-4
3.1.3.2	Using SQLJ	3-4
3.1.3.3	Example Comparing JDBC and SQLJ	3-6
3.1.3.4	SQLJ Strong Typing Paradigm	3-7
3.1.3.5	Translating a SQLJ Program	3-8
3.1.3.6	Interaction with PL/SQL	3-8
3.1.4	About Using the Command-Line Interface	3-8
3.1.5	Overview of Using the Client-Side Stub	3-10
3.1.5.1	Using the Default Service Feature	3-11
3.1.5.2	Testing the Default Service with a Basic Configuration	3-11
3.2	How To Tell Whether You Are Running on the Server	3-12
3.3	About Redirecting Output on the Server	3-12

4 Java Installation and Configuration

4.1	Initializing a Java-Enabled Database	4-1
4.1.1	Configuring the Oracle JVM Option within the Oracle Database Template	4-1
4.1.2	Modifying an Existing Oracle Database to Include Oracle JVM	4-1
4.2	Configuring Oracle JVM	4-2
4.3	The DBMS_JAVA Package	4-2
4.4	Enabling the Java Client	4-2

4.4.1	Installing Java SE on the Client	4-3
4.4.2	Setting Up Environment Variables	4-3
4.5	Two-Tier Duration for Java Session State	4-4
4.6	About Setting System Properties	4-4

5 Introduction to Nashorn JavaScript Engine

5.1	About Using Nashorn JavaScript Engine	5-1
5.1.1	Loading JavaScript Code into a Schema	5-2
5.1.2	How to run JavaScript in Oracle JVM	5-3
5.1.2.1	Using the DBMS_JAVASCRIPT.RUN PL/SQL Procedure	5-3
5.1.2.2	Using the DbmsJavaScript Java Class	5-3
5.1.2.3	Using the Standard javax.script Java Package	5-4
5.2	JavaScript Data Access using JDBC	5-6
5.3	REST Enable Your JavaScript Application	5-10

6 Developing Java Stored Procedures

6.1	Stored Procedures and Run-Time Contexts	6-1
6.1.1	Functions and Procedures	6-2
6.1.2	Database Triggers	6-2
6.1.3	Object-Relational Methods	6-2
6.2	Advantages of Stored Procedures	6-3
6.2.1	Performance	6-3
6.2.2	Productivity and Ease of Use	6-3
6.2.3	Scalability	6-4
6.2.4	Maintainability	6-4
6.2.5	Interoperability	6-4
6.2.6	Replication	6-4
6.2.7	Security	6-4
6.3	Running Java Stored Procedures	6-5
6.3.1	Creating or Reusing the Java Classes	6-6
6.3.2	Loading and Resolving the Java Classes	6-6
6.3.3	Publishing the Java Classes	6-6
6.3.4	Calling the Stored Procedures	6-7
6.4	Debugging Java Stored Procedures	6-7
6.4.1	Prerequisites for Debugging Java Stored Procedures	6-8
6.4.2	Debugging Java Stored Procedures Using the jdb Debugger	6-8
6.4.3	Debugging Java Stored Procedures Using JDeveloper	6-10

7 Publishing Java Classes With Call Specifications

7.1	What Are Call Specifications?	7-1
7.2	Defining Call Specifications	7-2
7.2.1	About Setting Parameter Modes	7-3
7.2.2	About Mapping Data Types	7-3
7.2.3	Using the Server-Side Internal JDBC Driver	7-5
7.3	Writing Top-Level Call Specifications	7-7
7.3.1	Examples	7-8
7.4	Writing Packaged Call Specifications	7-11
7.5	Writing Object Type Call Specifications	7-13
7.5.1	About Attributes	7-14
7.5.2	Declaring Methods	7-14
7.5.2.1	Map and Order Methods	7-15
7.5.2.2	Constructor Methods	7-15
7.5.2.3	Examples	7-16

8 Calling Stored Procedures

8.1	Calling Java from the Top Level	8-1
8.1.1	Redirecting the Output	8-1
8.1.2	Examples of Calling Java Stored Procedures From the Top Level	8-2
8.2	Calling Java from Database Triggers	8-4
8.3	Calling Java from SQL DML	8-7
8.4	Calling Java from PL/SQL	8-8
8.5	Calling PL/SQL from Java	8-10
8.6	How Oracle JVM Handles Exceptions	8-10

9 Java Stored Procedures Application Example

9.1	About Planning the Database Schema	9-1
9.2	Creating the Database Tables	9-2
9.3	Writing the Java Classes	9-3
9.4	Loading the Java Classes	9-7
9.5	Publishing the Java Classes	9-7
9.6	Calling the Java Stored Procedures	9-9

10 Oracle Database Java Application Performance

10.1	Oracle JVM Just-in-Time Compiler (JIT)	10-1
10.1.1	Overview of Oracle JVM JIT	10-1
10.1.2	Advantages of JIT Compilation	10-2

10.1.3	Methods Introduced in Oracle Database 11g	10-2
10.2	About Java Memory Usage	10-4
10.2.1	Configuring Memory Initialization Parameters	10-4
10.2.1.1	Initializing Pool Sizes within Database Templates	10-5
10.2.2	About Java Pool Memory	10-6
10.2.3	Displaying Used Amounts of Java Pool Memory	10-7
10.2.4	Correcting Out of Memory Errors	10-8
10.2.5	Displaying Java Call and Session Heap Statistics	10-9

11 Security for Oracle Database Java Applications

11.1	Network Connection Security	11-1
11.2	Database Contents and Oracle JVM Security	11-2
11.2.1	Overview of Java 2 Security Features	11-3
11.2.2	Overview of Setting Permissions	11-4
11.2.2.1	Fine-Grain Definition for Each Permission	11-5
11.2.2.2	Assigning General Permission Definition to Roles	11-19
11.2.3	Debugging Permissions	11-20
11.2.4	Permission for Loading Classes	11-20
11.2.5	Customizing the Default java.security Resource	11-21
11.3	Database Authentication Mechanisms Available with Oracle JVM	11-22
11.4	Secure Use of Runtime.exec Functionality in Oracle Database	11-23

12 Native Oracle JVM Support for JNDI

12.1	Overview of Oracle JVM Support for JNDI	12-1
12.2	Requirements for Oracle JVM Support for JNDI	12-1
12.2.1	Namespace	12-1
12.2.1.1	Object permissions	12-2
12.2.1.2	Persistent Storage Tables, Indexes, and Sequences	12-2
12.2.1.3	Initial Contexts and Permissions	12-3
12.2.1.4	Object and Context Default Permissions	12-3
12.2.2	Oracle Java Directory Service JNDI Name Space Provider	12-3
12.2.2.1	Directory Context	12-3
12.2.2.2	StateFactories	12-4
12.2.2.3	ObjectFactories	12-4
12.2.2.4	OJDS URL Support	12-4
12.2.2.5	Client classpath	12-5
12.2.3	Namespace Browser	12-5
12.3	OJDS Command-Line Tools	12-6
12.3.1	ls Command	12-6

12.3.2	cd Command	12-7
12.3.3	pwd Command	12-7
12.3.4	chown Command	12-8
12.3.5	mkdir Command	12-8
12.3.6	rm Command	12-9
12.3.7	ln Command	12-9
12.3.8	mv Command	12-10
12.3.9	chmod Command	12-10
12.3.10	bind Command	12-11
12.3.11	bindds Command	12-12
12.3.12	bindurl Command	12-13
12.4	OJDS APIs and Classes	12-14
12.4.1	oracle.aurora.jndi.ojds.OjdsClientContext	12-14
12.4.2	oracle.aurora.jndi.ojds.OjdsServerContext	12-15
12.4.3	oracle.aurora.jndi.ojds.OjdsInitialContextFactory	12-15
12.4.4	oracle.aurora.jndi.ojds.OjdsURLContextFactory	12-16
12.4.5	oracle.aurora.jndi.ojds.OjdsURLContext	12-16

13 Schema Objects and Oracle JVM Utilities

13.1	Overview of Schema Objects	13-1
13.2	What and When to Load	13-2
13.3	Resolution of Schema Objects	13-2
13.4	Compilation of Schema Objects	13-3
13.5	The ojvmtc Tool	13-4
13.5.1	About the ojvmtc Tool	13-5
13.5.2	Arguments of ojvmtc Command	13-5
13.6	The loadjava Tool	13-6
13.6.1	loadjava Tool Syntax	13-7
13.6.2	loadjava Tool Argument Summary	13-8
13.6.3	loadjava Tool Argument Details	13-13
13.7	The dropjava Tool	13-19
13.7.1	dropjava Tool Syntax	13-20
13.7.2	dropjava Tool Argument Summary	13-20
13.7.3	dropjava Tool Argument Details	13-21
13.7.4	About Dropping Resources Using dropjava Tool	13-22
13.8	The ojvmjava Tool	13-23
13.8.1	ojvmjava Tool Syntax	13-23
13.8.2	ojvmjava Tool Argument Summary	13-23
13.8.3	ojvmjava Tool Example	13-24
13.8.4	ojvmjava Tool Functionality	13-25

13.8.4.1	ojvmjava Tool Command-Line Options	13-25
13.8.4.2	ojvmjava Tool Shell Commands	13-26

14 Database Web Services

14.1	Overview of Database Web Services	14-1
14.2	About Using Oracle Database as Web Services Consumer	14-1
14.2.1	About Using Oracle JVM Web Services Call-Out Utility	14-2
14.2.1.1	Architecture of Oracle JVM Web Services Call-Out Utility	14-2
14.2.1.2	Input to Oracle JVM Web Services Call-Out Utility	14-4
14.2.1.3	Output of the Oracle JVM Web Services Call-Out Utility	14-6
14.2.1.4	Calling Secure Web Service from Oracle JVM Web Services Call-Out Utility	14-7
14.2.2	Web Service Data Sources (Virtual Table Support)	14-7
14.2.3	Features of Oracle Database as a Web Service Consumer	14-8

A DBMS_JAVA Package

A.1	longname	A-1
A.2	shortname	A-1
A.3	get_compiler_option	A-1
A.4	set_compiler_option	A-2
A.5	reset_compiler_option	A-2
A.6	resolver	A-2
A.7	derivedFrom	A-2
A.8	fixed_in_instance	A-3
A.9	set_output	A-3
A.10	export_source	A-4
A.11	export_class	A-4
A.12	export_resource	A-4
A.13	loadjava	A-4
A.14	dropjava	A-5
A.15	grant_permission	A-5
A.16	grant_permission	A-6
A.17	restrict_permission	A-6
A.18	restrict_permission	A-7
A.19	grant_policy_permission	A-7
A.20	grant_policy_permission	A-8
A.21	revoke_permission	A-8
A.22	disable_permission	A-9
A.23	enable_permission	A-9
A.24	delete_permission	A-9

A.25	set_preference	A-10
A.26	runjava	A-10
A.27	runjava_in_current_session	A-10
A.28	set_property	A-10
A.29	get_property	A-11
A.30	remove_property	A-11
A.31	show_property	A-12
A.32	set_output_to_sql	A-12
A.33	remove_output_to_sql	A-12
A.34	enable_output_to_sql	A-13
A.35	disable_output_to_sql	A-13
A.36	query_output_to_sql	A-13
A.37	set_output_to_java	A-13
A.38	remove_output_to_java	A-14
A.39	enable_output_to_java	A-14
A.40	disable_output_to_java	A-15
A.41	query_output_to_java	A-15
A.42	set_output_to_file	A-15
A.43	remove_output_to_file	A-16
A.44	enable_output_to_file	A-16
A.45	disable_output_to_file	A-16
A.46	query_output_to_file	A-16
A.47	enable_output_to_trc	A-17
A.48	disable_output_to_trc	A-17
A.49	query_output_to_trc	A-17
A.50	endsession	A-17
A.51	endsession_and_related_state	A-18
A.52	set_native_compiler_option	A-18
A.53	unset_native_compiler_option	A-18
A.54	compile_class	A-18
A.55	uncompile_class	A-19
A.56	compile_method	A-19
A.57	uncompile_method	A-19
A.58	start_jmx_agent	A-20
A.59	set_runtime_exec_credentials	A-20

B DBMS_JAVASCRIPT Package

B.1	DBMS_JAVASCRIPT Overview	B-1
B.1.1	The RUN Procedure	B-1

C Classpath Extensions and User Classloaded Metadata

C.1	Classpath Extensions	C-1
C.1.1	jserverQuotedClassPathTermPrefix	C-1
C.1.2	jserverURLPrefix	C-1
C.1.3	jserverSpecialTokenPrefix	C-1
C.1.4	JSERVER_CP	C-2
C.1.5	JSERVER_SCHEMAC	C-2
C.1.6	jserver:/CP general syntax	C-2
C.2	User Classloaded Metadata	C-3

Index

List of Tables

1-1	Feature List of Oracle JVM	1-18
2-1	Description of Java Code and Classes Storage in Oracle Database	2-4
2-2	Definitions for the Name and Option Parameters	2-9
2-3	Example JAVA\$OPTIONS Table	2-9
2-4	ORA Errors	2-13
2-5	Description of Java Files	2-16
2-6	loadjava Operations on Schema Objects	2-16
2-7	Key USER_OBJECT Columns	2-22
2-8	Statement Auditing Options Related to Java Schema Objects	2-24
2-9	Object Auditing Options Related to Java Schema Options	2-25
2-10	Description of the Overview Tab Fields in JConsole Interface	2-40
3-1	Command Line Argument Summary	3-9
3-2	set_output_to_sql Argument Summary	3-13
3-3	set_output_to_java Argument Summary	3-16
7-1	Legal Data Type Mappings	7-3
11-1	Predefined Permissions	11-15
11-2	JServerPermission Description	11-16
11-3	SYS Initial Permissions	11-17
11-4	PUBLIC Default Permissions	11-17
11-5	JAVAUSERPRIV Permissions	11-18
11-6	JAVASYSPRIV Permissions	11-19
11-7	JVADEBUGPRIV Permissions	11-19
13-1	ojvmtc Argument Summary	13-5
13-2	loadjava Argument Summary	13-8
13-3	dropjava Argument Summary	13-20
13-4	ojvmjava Argument Summary	13-24
13-5	ojvmjava Command Common Options	13-26
13-6	java Argument Summary	13-28
13-7	connect Argument Summary	13-29
13-8	runjava Argument Summary	13-29
13-9	jdwp Argument Summary	13-30
14-1	Input to Oracle JVM Web Services Call-Out Utility	14-4
14-2	Output of the Oracle JVM Web Services Call-Out Utility	14-7

Preface

Java is the object-oriented programming language of choice that provides platform independence and automated storage management techniques. It enables you to create applications and applets. Oracle Database provides support for developing and deploying Java applications.

Audience

The Oracle Database Java Developer's Guide is intended for both Java and non-Java developers. For PL/SQL developers who are not familiar with Java programming, this manual provides a brief overview of Java and object-oriented concepts. For both Java and PL/SQL developers, this manual discusses the following:

- How Java and Database concepts merge
- How to develop, load, and run Java stored procedures
- Oracle JVM
- Database concepts for managing Java objects in the database
- Oracle Database and Java security policies

To use this document, you need knowledge of Oracle Database, SQL, and PL/SQL. Prior knowledge of Java and object-oriented programming can be helpful.

Documentation Accessibility

For information about Oracle's commitment to accessibility, visit the Oracle Accessibility Program website at <http://www.oracle.com/pls/topic/lookup?ctx=acc&id=docacc>.

Access to Oracle Support

Oracle customers that have purchased support have access to electronic support through My Oracle Support. For information, visit <http://www.oracle.com/pls/topic/lookup?ctx=acc&id=info> or visit <http://www.oracle.com/pls/topic/lookup?ctx=acc&id=trs> if you are hearing impaired.

Related Documents

For more information, refer to the following Oracle resources:

- *Oracle Database JDBC Developer's Guide*
- *Oracle Database SQLJ Developer's Guide*
- *Oracle Database Net Services Administrator's Guide*

- *Oracle Database Advanced Security Guide*
- *Oracle Database Development Guide*

Conventions

The following conventions are also used in this manual:

Convention	Meaning
...	Vertical ellipsis points in an example mean that information not directly related to the example has been omitted.
...	Horizontal ellipsis points in statements or commands mean that parts of the statement or command not directly related to the example have been omitted
boldface text	Boldface type in text indicates a term defined in the text, the glossary, or in both locations.
< >	Angle brackets enclose user-supplied names.
[]	Brackets enclose optional clauses from which you can choose one or none.

Changes in This Release for Oracle Database Java Developer's Guide

This preface contains:

- [Changes in Oracle Database 19c](#)

Changes in Oracle Database 19c

The following are the changes in the *Oracle Database Java Developer's Guide* for Oracle Database 19c.

New Features

There are no new features for Oracle JVM in Oracle Database Release 19c.

1

Introduction to Java in Oracle Database

Oracle Database provides support for developing, storing, and deploying Java applications. This chapter introduces the Java language to Oracle PL/SQL developers, who are accustomed to developing server-side applications that are integrated with SQL data. You can develop server-side Java applications that take advantage of the scalability and performance of Oracle Database.

This chapter contains the following sections:

- [Overview of Java](#)
- [About Using Java in Oracle Database](#)
- [Overview of Oracle JVM](#)
- [Feature List of Oracle JVM](#)
- [Main Components of Oracle JVM](#)
- [Java Programming in Oracle Database](#)
- [Support for Java 8](#)
- [Introduction to Nashorn JavaScript Engine](#)
- [Memory Model for Dedicated Mode Sessions](#)

1.1 Overview of Java

Java has emerged as the object-oriented programming language of choice. Some of the important concepts of Java include:

- A Java virtual machine (JVM), which provides the fundamental basis for platform independence
- Automated storage management techniques, such as garbage collection
- Language syntax that is similar to that of the C language

The result is a language that is object-oriented and efficient for application programming.

This section covers the following topics:

- [Java and Object-Oriented Programming Terminology](#)
- [Key Features of the Java Language](#)
- [Java Virtual Machine](#)
- [Java Class Hierarchy](#)

1.1.1 Java and Object-Oriented Programming Terminology

The following terms are common in Java application development in Oracle Database environment:

- [Classes](#)
- [Objects](#)
- [Interfaces](#)
- [Encapsulation](#)
- [Inheritance](#)
- [Polymorphism](#)

1.1.1.1 Classes

All object-oriented programming languages support the concept of a class. As with a table definition, a class provides a template for objects that share common characteristics. Each class can define the following:

- **Fields**

Fields are variables that are present in each object or instance of a particular class, or are variables that are global and common to all instances. Instance fields are analogous to the columns of a relational table row. The class defines the fields and the type of each field.

You can declare fields in Java as `static`. Fields of a class that are declared as `static` are global and common to all instances of that class. There is only one value at any given time for a static field within a given instantiation of a Java runtime. Fields that are not declared as `static` are created as distinct values within each instance of the class.

The `public`, `private`, `protected`, and default access modifiers define the scope of the field in the application. The Java Language Specification (JLS) defines the rules of visibility of data for all fields. These rules define under what circumstances you can access the data in these fields.

In the example illustrated in [Figure 1-1](#), the employee identifier is defined as `private`, indicating that other objects cannot access this field directly. In the example, objects can access the `id` field by calling the `getId()` method.

- **Methods**

Methods are procedures associated with a class. Like a field, a method can be declared as `static`, in which case it can be called globally. If a method is not declared as `static`, it means that the method is an instance method and can be called only as an operation on an object, where the object is an instance of the class.

Similar to fields, methods can be declared as `public`, `private`, `protected`, or default access. This declaration defines the scope in which the method can be called.

1.1.1.2 Objects

A Java object is an instance of a class and is analogous to a relational table row. Objects are collections of data values, the individual elements of which are described by the non-static field definitions of the class.

[Figure 1-1](#) shows an example of an `Employee` class defined with two fields, `id`, which is the employee identifier, and `lastName`, which is the last name of the employee, and the

`getId()` and `setId(String anId)` methods. The `id` field is private, and the `lastName` field, the `getId()` method and the `setId(String anId)` method are public.

Figure 1-1 Classes and Instances

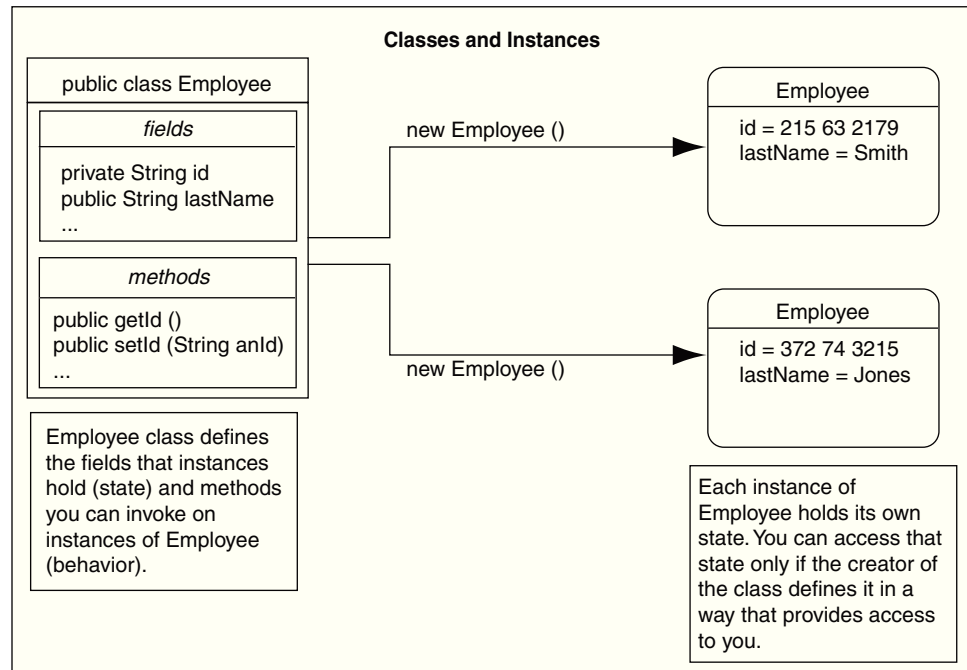

When you create an instance, the fields store individual and private information relevant only to the employee. That is, the information contained within an employee instance is known only to that particular employee. The example in [Figure 1-1](#) shows two instances of the `Employee` class, one for the employee Smith and one for Jones. Each instance contains information relevant to the individual employee.

1.1.1.3 Inheritance

Inheritance is an important feature of object-oriented programming languages. It enables classes to include properties of other classes. The class that inherits the properties is called a child class or subclass, and the class from which the properties are inherited is called a parent class or superclass. This feature also helps in reusing already defined code.

In the example illustrated in [Figure 1-1](#), you can create a `FullTimeEmployee` class that inherits the properties of the `Employee` class. The properties inherited depend on the access modifiers declared for each field and method of the superclass.

1.1.1.4 Interfaces

Java supports only single inheritance, that is, each class can inherit fields and methods of only one class. If you need to inherit properties from more than one source, then Java provides the concept of interfaces, which is a form of multiple inheritance. Interfaces are similar to classes. However, they define only the signature of the methods and not their implementations. The methods that are declared in the

interface are implemented in the classes. Multiple inheritance occurs when a class implements multiple interfaces.

1.1.1.5 Encapsulation

Encapsulation describes the ability of an object to hide its data and methods from the rest of the world and is one of the fundamental principles of object-oriented programming. In Java, a class encapsulates the fields, which hold the state of an object, and the methods, which define the actions of the object. Encapsulation enables you to write reusable programs. It also enables you to restrict access only to those features of an object that are declared `public`. All other fields and methods are `private` and can be used for internal object processing.

In the example illustrated in [Figure 1-1](#), the `id` field is `private`, and access to it is restricted to the object that defines it. Other objects can access this field using the `getId()` method. Using encapsulation, you can deny access to the `id` field either by declaring the `getId()` method as `private` or by not defining the `getId()` method.

1.1.1.6 Polymorphism

Polymorphism is the ability for different objects to respond differently to the same message. In object-oriented programming languages, you can define one or more methods with the same name. These methods can perform different actions and return different values.

In the example in [Figure 1-1](#), assume that the different types of employees must be able to respond with their compensation to date. Compensation is computed differently for different types of employees:

- Full-time employees are eligible for a bonus.
- Non-exempt employees get overtime pay.

In procedural languages, you write a `switch` statement, with the different possible cases defined, as follows:

```
switch: (employee.type)
{
  case: Employee
    return employee.salaryToDate;
  case: FullTimeEmployee
    return employee.salaryToDate + employee.bonusToDate
  ...
}
```

If you add a new type of employee, then you must update the `switch` statement. In addition, if you modify the data structure, then you must modify all `switch` statements that use it. In an object-oriented language, such as Java, you can implement a method, `compensationToDate()`, for each subclass of the `Employee` class, if it contains information beyond what is already defined in the `Employee` class. For example, you could implement the `compensationToDate()` method for a non-exempt employee, as follows:

```
public float compensationToDate()
{
  return (super.compensationToDate() + this.overtimeToDate());
}
```

For a full-time employee, the `compensationToDate()` method can be implemented as follows:

```
public float compensationToDate()
{
    return (super.compensationToDate() + this.bonusToDate());
}
```

This common use of the method name enables you to call methods of different classes and obtain the required results, without specifying the type of the employee. You do not have to write specific methods to handle full-time employees and part-time employees.

In addition, you can create a `Contractor` class that does not inherit properties from `Employee` and implements a `compensationToDate()` method in it. A program that calculates total payroll to date would iterate over all people on payroll, regardless of whether they were full-time or part-time employees or contractors, and add up the values returned from calling the `compensationToDate()` method on each. You can safely make changes to the individual `compensationToDate()` methods or the classes, and know that callers of the methods will work correctly.

1.1.2 Key Features of the Java Language

The Java language provides certain key features that make it ideal for developing server applications. These features include:

- **Simplicity**

Java is simpler than most other languages that are used to create server applications, because of its consistent enforcement of the object model. The large, standard set of class libraries brings powerful tools to Java developers on all platforms.

- **Portability**

Java is portable across platforms. It is possible to write platform-dependent code in Java, and it is also simple to write programs that move seamlessly across systems.



See Also:

"[Java Virtual Machine](#)"

- **Automatic storage management**

A JVM automatically performs all memory allocation and deallocation while the program is running. Java programmers cannot explicitly allocate memory for new objects or free memory for objects that are no longer referenced. Instead, they depend on a JVM to perform these operations. The process of freeing memory is known as garbage collection.

- **Strong typing**

Before you use a field, you must declare the type of the field. Strong typing in Java makes it possible to provide a reasonable and safe solution to interlanguage calls between Java and PL/SQL applications, and to integrate Java and SQL calls within the same application.

- No pointers

Although Java is quite similar to C in its syntax, it does not support direct pointers or pointer manipulation. You pass all parameters, except primitive types, by reference and not by value. As a result, the object identity is preserved. Java does not provide low level, direct access to pointers, thereby eliminating any possibility of memory corruption and leaks.
- Exception handling

Java exceptions are objects. Java requires developers to declare which exceptions can be thrown by methods in any particular class.
- Flexible namespace

Java defines classes and places them within a hierarchical structure that mirrors the domain namespace of the Internet. You can distribute Java applications and avoid name collisions. Java extensions, such as the Java Naming and Directory Interface (JNDI), provide a framework for multiple name services to be federated. The namespace approach of Java is flexible enough for Oracle to incorporate the concept of a schema for resolving class names in full compliance with the JLS.
- Security

The design of Java bytecodes and JVM specification allow for built-in mechanisms to verify the security of Java binary code. Oracle Database is installed with an instance of Security Manager that, when combined with Oracle Database security, determines who can call any Java methods.
- Standards for connectivity to relational databases

Java Database Connectivity (JDBC) and SQLJ enable Java code to access and manipulate data in relational databases. Oracle provides drivers that allow vendor-independent, portable Java code to access the relational database.

1.1.3 Java Virtual Machine

As with other high-level computer languages, the Java source compiles to low-level machine instructions. In Java, these instructions are known as bytecodes, because each instruction has a uniform size of one byte. Most other languages, such as C, compile to machine-specific instructions, such as instructions specific to an Intel or HP processor.

When compiled, the Java code gets converted to a standard, platform-independent set of bytecodes, which are executed by a Java Virtual Machine (JVM). A JVM is a separate program that is optimized for the specific platform on which you run your Java code.

[Figure 1-2](#) illustrates how Java can maintain platform independence. Each platform has a JVM installed that is specific to the operating system. The Java bytecodes get interpreted through the JVM into the appropriate platform dependent actions.

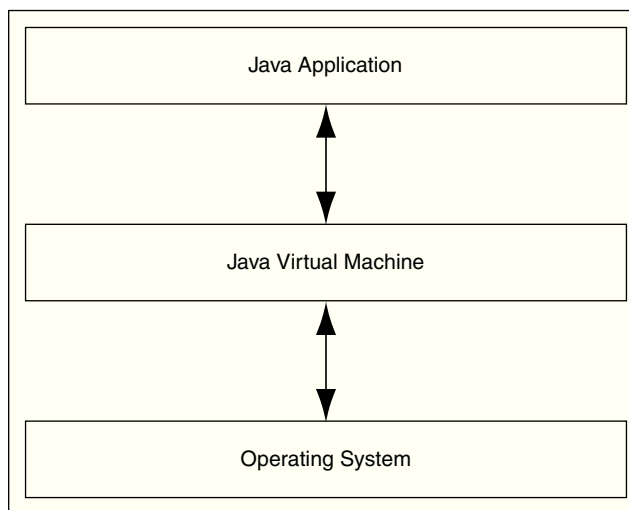
Figure 1-2 Java Component Structure

When you develop a Java application, you use predefined core class libraries written in the Java language. The Java core class libraries are logically divided into packages that provide commonly used functionality. Basic language support is provided by the `java.lang` package, I/O support is provided by the `java.io` package, and network access is provided by the `java.net` package. Together, a JVM and the core class libraries provide a platform on which Java programmers can develop applications, which will run successfully on any operating system that supports Java. This concept is what drives the "write once, run anywhere" idea of Java.

Figure 1-3 illustrates how Oracle Java applications reside on top of the Java core class libraries, which reside on top of the JVM. Because the Oracle Java support system is located within the database, the JVM interacts with Oracle Database libraries, instead of directly interacting with the operating system.

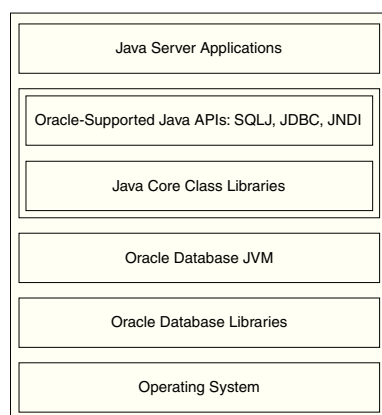
Figure 1-3 Oracle Database Java Component Structure

To know more about Java and JVM, you can refer to the Java Language Specification (JLS) and the JVM specification. The JLS defines the syntax and semantics, and the JVM specification defines the necessary low-level actions for the system that runs the application. In addition, there is also a compatibility test suite for JVM implementors to

determine if they have complied with the specifications. This test suite is known as the Java Compatibility Kit (JCK). Oracle JVM implementation complies fully with JCK. Part of the overall Java strategy is that an openly specified standard, together with a simple way to verify compliance with that standard, allows vendors to offer uniform support for Java across all platforms.

1.1.4 Java Class Hierarchy

Java defines classes within a large hierarchy of classes. At the top of the hierarchy is the `Object` class. All classes in Java inherit from the `Object` class at some level, as you walk up through the inheritance chain of superclasses. When we say Class B inherits from Class A, each instance of Class B contains all the fields defined in class B, as well as all the fields defined in Class A.

Figure 1-4 illustrates a generic Java class hierarchy. The `FullTimeEmployee` class contains the `id` and `lastName` fields defined in the `Employee` class, because it inherits from the `Employee` class. In addition, the `FullTimeEmployee` class adds another field, `bonus`, which is contained only within `FullTimeEmployee`.

You can call any method on an instance of Class B that was defined in either Class A or Class B. In the example, the `FullTimeEmployee` instance can call methods defined only in the `FullTimeEmployee` class and methods defined in the `Employee` class.

Figure 1-4 Class Hierarchy

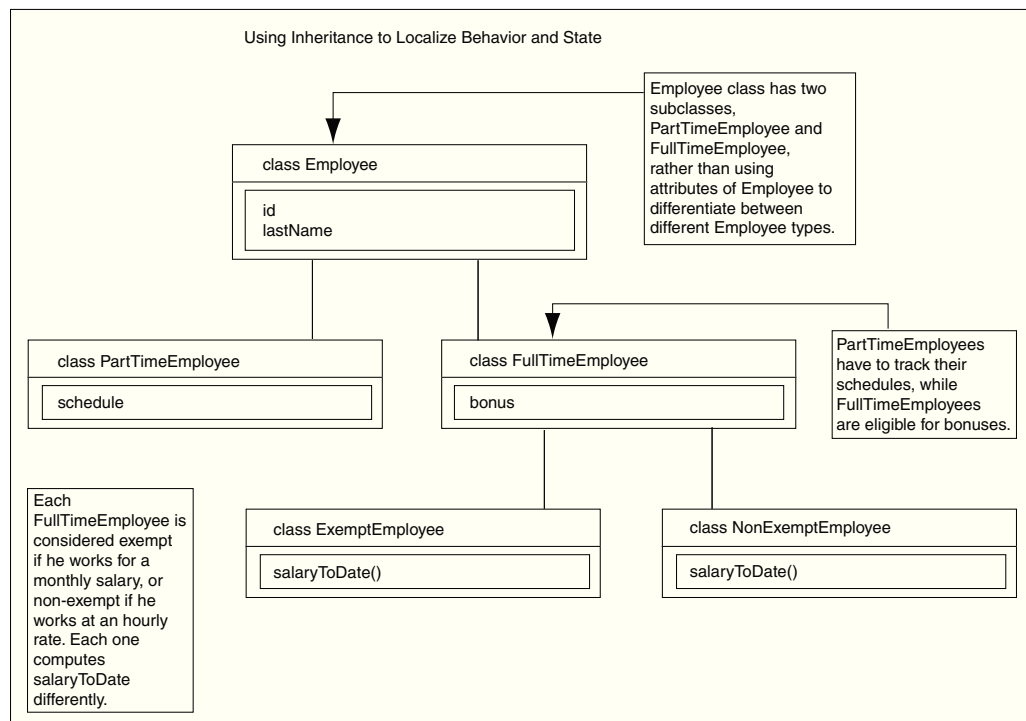

Instances of Class B can be substituted for instances of Class A, which makes inheritance another powerful construct of object-oriented languages for improving code reuse. You can create classes that define behavior and state where it makes sense in the hierarchy, yet make use of preexisting functionality in class libraries.

1.2 About Using Java in Oracle Database

You can write and load Java applications within the database because it is a safe language with a lot of security features. Java has been developed to prevent anyone from tampering with the operating system where the Java code resides in. Some languages, such as C, can introduce security problems within the database. However, Java, because of its design, is a robust language that can be used within the database.

Although the Java language presents many advantages to developers, providing an implementation of a JVM that supports Java server applications in a scalable manner is a challenge. This section discusses the following challenges:

- [Java and RDBMS: A Robust Combination](#)
- [About Multithreading](#)
- [Memory Spaces Management](#)
- [Footprint](#)
- [Performance of an Oracle JVM](#)
- [Dynamic Class Loading](#)

1.2.1 Java and RDBMS: A Robust Combination

Oracle Database provides Java applications with a dynamic data-processing engine that supports complex queries and different views of the same data. All client requests are assembled as data queries for immediate processing, and query results are generated dynamically.

The combination of Java and Oracle Database helps you to create component-based, network-centric applications that can be easily updated as business needs change. In addition, you can move applications and data stores off the desktop and onto intelligent networks and network-centric servers. More important, you can access those applications and data stores from any client device.

[Figure 1-5](#) shows a traditional two-tier, client/server configuration in which clients call Java stored procedures the same way they call PL/SQL stored procedures. The figure also shows how Oracle Net Services Connection Manager can combine many network connections into a single database connection. This enables Oracle Database to support a large number of concurrent users.

Figure 1-5 Two-Tier Client/Server Configuration

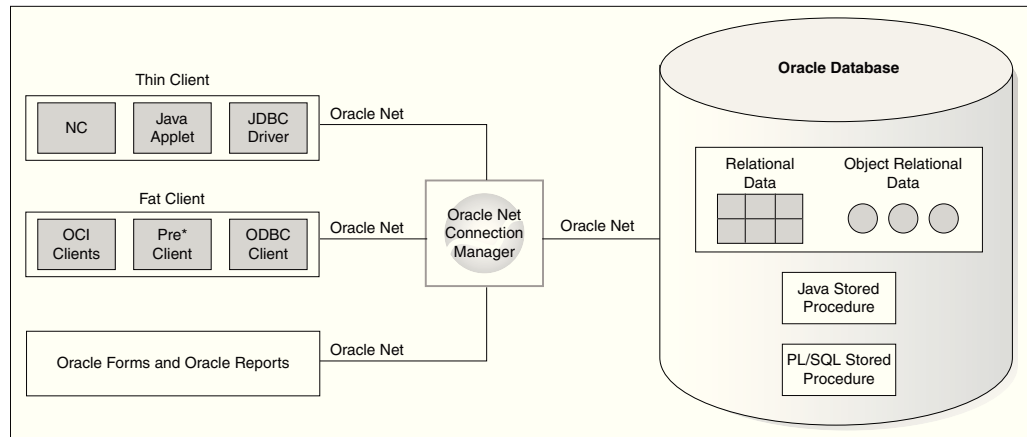

1.2.2 About Multithreading

Multithreading is one of the key scalability features of the Java language. The Java language and class libraries make it simpler to write multithreaded applications in Java than many other languages, but it is still a daunting task in any language to write reliable, scalable multithreaded code.

Oracle Database server efficiently schedules work for thousands of users. The Oracle JVM takes advantage of the session architecture of Oracle database to concurrently run Java applications for hundreds to thousands of users. Although Oracle Database supports Java language-level threads required by the JLS and JCK, scalability will not increase by using threads within the scope of the database. By using the embedded scalability of the database, the need for writing multithreaded Java servers is eliminated.

You should use the facilities of Oracle Database for scheduling users by writing single-threaded Java applications. The database can schedule processes between each application, and thus, you achieve scalability without having to manage threads. You can still write multithreaded Java applications, but multiple Java threads will not increase the performance of the server.

One complication multithreading creates is the interaction of threads and automated storage management or garbage collection. The garbage collector running in a generic JVM has no knowledge of which Java language threads are running or how the underlying operating system schedules them. The difference between a non-Oracle Database model and an Oracle JVM model is as follows:

- Non-Oracle Database model

A single user maps to a single Java thread and a single garbage collector manages all garbage from all users. Different techniques typically deal with allocation and collection of objects of varying lifetimes and sizes. The result in a heavily multithreaded application is, at best, dependent upon operating system support for native threads, which can be unreliable and limited in scalability. High levels of scalability for such implementations have not been convincingly demonstrated.

- Oracle JVM model

Even when thousands of users connect to the server and run the same Java code, each user experiences it as if he or she is running his or her own Java code on his or her own JVM. The responsibility of an Oracle JVM is to make use of operating system processes and threads and the scalable approach of Oracle Database. As a result of this approach, the garbage collector of the Oracle JVM is more reliable and efficient because it never collects garbage from more than one user at any time.

**See Also:**

["Overview of Threading in Oracle Database"](#)

1.2.3 Memory Spaces Management

Garbage collection is a major function of the automated storage management feature of Java, eliminating the need for Java developers to allocate and free memory explicitly. Consequently, this eliminates a large source of memory leaks that are commonly found in C and C++ programs. However, garbage collection contributes to the overhead of program execution speed and footprint.

Garbage collection imposes a challenge to the JVM developer seeking to supply a highly scalable and fast Java platform. An Oracle JVM meets these challenges in the following ways:

- The Oracle JVM uses Oracle Database scheduling facilities, which can manage multiple users efficiently.
- Garbage collection is performed consistently for multiple users, because garbage collection is focused on a single user within a single session. The Oracle JVM has an advantage, because the burden and complexity of the job of the memory manager does not increase as the number of users increases. The memory manager performs the allocation and collection of objects within a single session, which typically translates to the activity of a single user.
- The Oracle JVM uses different garbage collection techniques depending on the type of memory used. These techniques provide high efficiency and low overhead.

The two types of memory space are call space and session space.

Memory space	Description
Call space	It is a fast and inexpensive type of memory. It primarily exists for the length of a call. Call memory space is divided into new and old segments. All new objects are created within new memory. Objects that have survived several scavenges are moved into old memory.
Session space	It is an expensive, performance-wise memory. It primarily exists for the length of a session. All <code>static</code> fields and any objects that exist beyond the lifetime of a call exist here.

Figure 1-6 illustrates the different actions performed by the garbage collector.

Figure 1-6 Garbage Collection

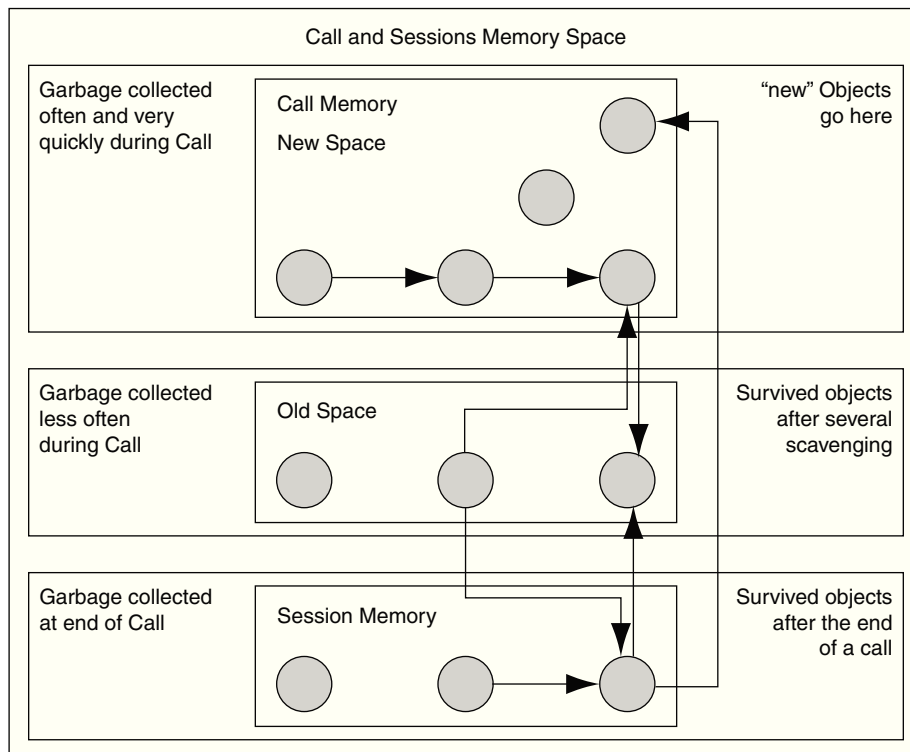

Garbage collection algorithms within an Oracle JVM adhere to the following rules:

1. New objects are created within a new call space.
2. Scavenging occurs at a set interval. Some programmers create objects frequently for only a short duration. These types of objects are created and garbage-collected quickly within the new call space. This is known as **scavenging**.
3. Any objects that have survived several iterations of scavenging are considered to be objects that can exist for a while. These objects are moved out of new call space into old call space. During the move, they are also compacted. Old call space is scavenged or garbage collected less often and, therefore, provides better performance.
4. At the end of the call, any objects that are to exist beyond the call are moved into session space.

Figure 1-6 illustrates the steps listed in the preceding text. This approach applies sophisticated allocation and collection schemes tuned to the types and lifetimes of objects. For example, new objects are allocated in fast and inexpensive call memory, designed for quick allocation and access. Objects held in Java `static` fields are migrated to the more precious and expensive session space.

1.2.4 Footprint

The footprint of a running Java program is affected by many factors:

- Size of the program

The size of the program depends on the number of classes and methods and how much code they contain.

- Complexity of the program

The complexity of the program depends on the number of core class libraries that the Oracle JVM uses as the program runs, as opposed to the program itself.

- Amount of space the JVM uses

The amount of space the JVM uses depends on the number of objects the JVM allocates, how large these objects are, and how many objects must be retained across calls.

- Ability of the garbage collector and memory manager to deal with the demands of the program running

This can not be determined often. The speed with which objects are allocated and the way they are held on to by other objects influences the importance of this factor.

From a scalability perspective, the key to supporting multiple clients concurrently is a minimum per-user session footprint. The Oracle JVM keeps the per-user session footprint to a minimum by placing all read-only data for users, such as Java bytecodes, in shared memory. Appropriate garbage collection algorithms are applied against call and session memories to maintain a small footprint for the user's session. The Oracle JVM uses the following types of garbage collection algorithms to maintain the user's session memory:

- Generational scavenging for short-lived objects
- Mark and lazy sweep collection for objects that exist for the life of a single call
- Copying collector for long-lived objects, that is, objects that live across calls within a session

1.2.5 Performance of an Oracle JVM

The performance of an Oracle JVM is enhanced by the embedding of an innovative Just-In-Time compiler similar to HotSpot on standard JVM. The platform-independent Java bytecodes run on top of a JVM, and the JVM interacts with the specific hardware platform. Any time you add levels within software, the performance is degraded. Because Java requires going through an intermediary to interpret the bytecodes, a degree of inefficiency exists for Java applications as compared to applications developed using a platform-dependent language, such as C. To address this issue, several JVM suppliers create native compilers. Native compilers translate Java bytecodes into platform-dependent native code, which eliminates the interpreter step and improves performance.

The following table describes two methods for native compilation:

Compiler	Description
Just-In-Time (JIT) Compilation	JIT compilers quickly compile Java bytecodes to platform-specific, or native, machine code during run time. These compilers do not produce an executable file to be run on the platform. Instead, they provide platform-dependent code from Java bytecodes that is run directly after it is translated. JIT compilers should be used for Java code that is run frequently and at speeds closer to that of code developed in other languages, such as C.

Compiler	Description
Ahead-of-Time Compilation	This compilation translates Java bytecodes to platform-independent C code before run time. Then a standard C compiler compiles the C code into an executable file for the target platform. This approach is more suitable for Java applications that are not modified frequently. This approach takes advantage of the mature and efficient platform-specific compilation technology found in modern C compilers.

Oracle Database uses Just-In-Time (JIT) compilation to deliver its core Java class libraries, such as JDBC code, in natively compiled form. The JIT compiler is enabled without the support of any plug-ins and it is applicable across all the platforms that Oracle supports.

The following figure illustrates how natively compiled code runs up to 10 times faster than interpreted code. As a result, the more native code your program uses, the faster it runs.

Figure 1-7 Interpreter versus Accelerator

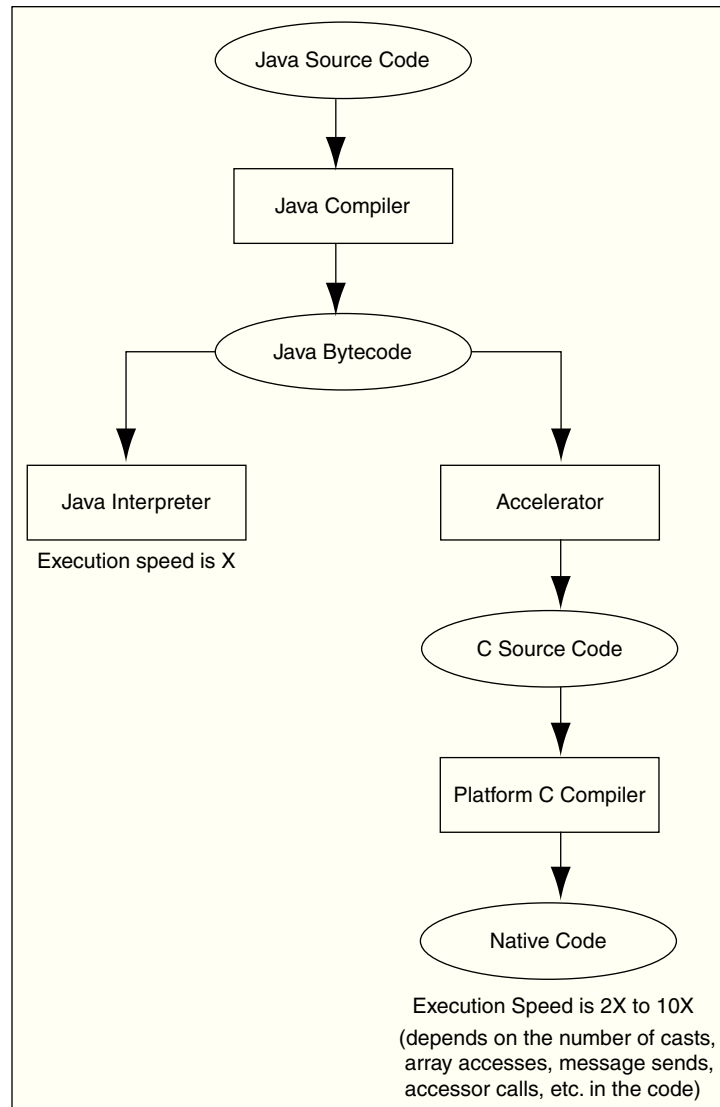

Related Topics

- [Oracle JVM Just-in-Time Compiler \(JIT\)](#)

1.2.6 Dynamic Class Loading

Another strong feature of Java is dynamic class loading. The class loader loads classes from the disk and places them in the JVM-specific memory structures necessary for interpretation. The class loader locates the classes in `CLASSPATH` and loads them only when they are used while the program is running. This approach, which works well for applets, poses the following problems in a server environment:

Problem	Description	Solution
Predictability	The class loading operation places a severe penalty when the program is run for the first time. A simple program can cause an Oracle JVM to load many core classes to support its needs. A programmer cannot easily predict or determine the number of classes loaded.	The Oracle JVM loads classes dynamically, just as with any other JVM. The same one-time class loading speed hit is encountered. However, because the classes are loaded into shared memory, no other users of those classes will cause the classes to load again, and they will use the same preloaded classes.
Reliability	A benefit of dynamic class loading is that it supports program updating. For example, you would update classes on a server, and clients, who download the program and load it dynamically, see the update whenever they next use the program. Server programs tend to emphasize reliability. As a developer, you must know that every client runs a specific program configuration. You do not want clients to inadvertently load some classes that you did not intend them to load.	Oracle Database separates the upload and resolve operation from the class loading operation at run time. You upload Java code you developed to the server using the <code>loadjava</code> tool. Instead of using <code>CLASSPATH</code> , you specify a resolver at installation time. The resolver is analogous to <code>CLASSPATH</code> , but enables you to specify the schemas in which the classes reside. This separation of resolution from class loading ensures that you always know what programs users run.

1.3 Overview of Oracle JVM

The Oracle JVM is a standard, Java-compatible environment that runs any pure Java application. It is compatible with the standard JLS and the JVM specifications. It supports the standard Java binary format and the standard Java APIs. In addition, Oracle Database adheres to standard Java language semantics, including dynamic class loading at run time.

Java in Oracle Database introduces the following terms:

- **Session**
A session in Oracle Database Java environment is identical to the standard Oracle Database usage. A session is typically, although not necessarily, bounded by the time a single user connects to the server. As a user who calls a Java code, you must establish a session in the server.
- **Call**

When a user causes a Java code to run within a session, it is termed as a call. A call can be started in the following different ways:

- A SQL client program runs a Java stored procedure.
- A trigger runs a Java stored procedure.
- A PL/SQL program calls a Java code.

In all the cases defined, a call begins, some combination of Java, SQL, or PL/SQL code is run to completion, and the call ends.

**Note:**

The concept of session and call apply across all uses of Oracle Database.

Unlike other Java environments, the Oracle JVM is embedded within Oracle Database and introduces a number of new concepts. This section discusses some important differences between an Oracle JVM and typical client JVMs based on:

- [Process Area](#)
- [Java session initialization_ duration and entrypoints](#)
- [The GUI](#)
- [The IDE](#)

1.3.1 Process Area

In a standard Java environment, you run a Java application through the interpreter by issuing the following command on the command line, where *classname* is the name of the class that you want the JVM to interpret first:

```
java classname
```

When using the Oracle JVM, you must load the application into the database, publish the interface, and then run the application within a database session. The database session is the environment in which the Oracle JVM runs and as such is the analog of the operating system process in which a standard client JVM runs.

Related Topics

- [Java Applications on Oracle Database](#)

1.3.2 Java session initialization, duration and entrypoints

Standard client-based Java applications declare a single, top-level method, `public static void main(String args[])`. This method is executed once and the instantiation of the Java Virtual Machine lasts for the duration of that call. But, Oracle Java applications are not restricted to a single top-level main entrypoint, and the duration of the Oracle JVM instantiation is not determined by a single call and the exit of the call from this entrypoint. Each client begins a session, calls its server-side logic modules through top-level entry points, and eventually ends the session. The same JVM instance remains in place for the entire duration of the session, so data state such as static variable values can be used across multiple calls to multiple top-level entry points.

Class definitions that have been loaded and published in the database are generally available to all sessions in that database. The JVM instance in a given session and the Java data objects and global field values in that JVM instance are private to the session. This data is present for the duration of the session and may be used by multiple calls within the lifetime of that session. But, neither this data is visible to other sessions nor the data can be shared in any way with other sessions. This is analogous to how in a standard client Java application separate invocations of the main method share the same class definitions, but the data created and used during those invocations are separate.

1.3.3 The GUI

A server cannot provide GUIs, but it can provide the logic that drives them. The Oracle JVM supports only the headless mode of the Java Abstract Window Toolkit (AWT). All Java AWT classes are available within the server environment and your programs can use the Java AWT functionality, as long as they do not attempt to materialize a GUI on the server.

Related Topics

- [User Interfaces on the Server](#)

1.3.4 The IDE

The Oracle JVM is oriented to Java application deployment, and not development. You can write and test applications on any preferred integrated development environment (IDE), such as Oracle JDeveloper, and then deploy them within the database for the clients to access and run them.



See Also:

["Development Tools"](#)

The binary compatibility of Java enables you to work on any IDE and then upload the Java class files to the server. You need not move your Java source files to the database. Instead, you can use powerful client-side IDEs to maintain Java applications that are deployed on the server.

Related Topics

- [Development Tools](#)

1.4 Feature List of Oracle JVM

[Table 1-1](#) lists the features of Oracle JVM and the versions in which they were first supported.

Table 1-1 Feature List of Oracle JVM

Feature	Supported Since Oracle JVM Release
loadjava URL support	11.1
List-Based operations with dropjava support	11.1
ojvmtc Tool	11.1
Runjava command-line interface (JDK-like interface)	11.1
Database-Resident JARs	11.1
Sharing of user classloaded classes metadata support	11.1
Two-tier duration for the Java session state support	11.1
Default service feature	11.1
Just-in-Time compiler (JIT)	11.1
Internet Protocol Version 6 (IPv6) Support	11.2
JDK 6 support	12.1
JDK 7 support	12.1
JDK 8 support	12.2

1.5 Main Components of Oracle JVM

This section briefly describes the main components of an Oracle JVM and some of the facilities they provide.

The Oracle JVM is a complete, Java 2-compliant environment for running Java applications. It runs in the same process space and address space as the database kernel by sharing its memory heaps and directly accessing its relational data. This design optimizes memory use and increases throughput.

The Oracle JVM provides a run-time environment for Java objects. It fully supports Java data structures, method dispatch, exception handling, and language-level threads. It also supports all the core Java class libraries, including `java.lang`, `java.io`, `java.net`, `java.math`, and `java.util`.

[Figure 1-8](#) shows the main components of an Oracle JVM.

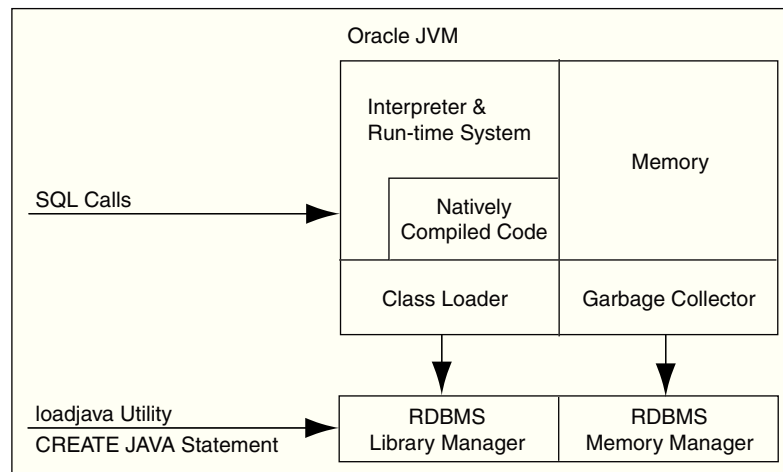
Figure 1-8 Main Components of an Oracle JVM

The Oracle JVM embeds the standard Java namespace in the database schemas. This feature lets Java programs access Java objects stored in Oracle Database and application servers across the enterprise.

In addition, the Oracle JVM is tightly integrated with the scalable, shared memory architecture of the database. Java programs use call, session, and object lifetimes efficiently without user intervention. As a result, the Oracle JVM and middle-tier Java business objects can be scaled, even when they have session-long state.

The following sections provide an overview of some of the components of the Oracle JVM and the JDBC driver and the SQLJ translator:

- [Library Manager](#)
- [Compiler](#)
- [Interpreter](#)
- [Class Loader](#)
- [Verifier](#)
- [Server-Side JDBC Internal Driver](#)
- [Server-Side SQLJ Translator](#)
- [System Classes](#)

1.5.1 Library Manager

To store Java classes in Oracle Database, you use the `loadjava` command-line tool, which uses the `SQL CREATE JAVA` statements to do its work. When called by the `CREATE JAVA {SOURCE | CLASS | RESOURCE}` statement, the library manager loads Java source, class, or resource files into the database. These Java schema objects are not accessed directly, and only an Oracle JVM uses them.

1.5.2 Compiler

The Oracle JVM includes a standard Java compiler. When the `CREATE JAVA SOURCE` statement is run, it translates Java source files into architecture-neutral, one-byte instructions known as bytecodes. Each bytecode consists of an opcode followed by its operands. The resulting Java class files, which conform fully to the Java standard, are submitted to the interpreter at run time.

1.5.3 Interpreter

To run Java programs, the Oracle JVM includes a standard Java 2 bytecode interpreter. The interpreter and the associated Java run-time system run standard Java class files. The run-time system supports native methods and call-in and call-out from the host environment.



Note:

You can also compile your Java code to improve performance. The Oracle JVM uses natively compiled versions of the core Java class libraries, SQLJ translator, and JDBC drivers.

1.5.4 Class Loader

In response to requests from the run-time system, the Java class loader locates, loads, and initializes Java classes stored in the database. The class loader reads the class and generates the data structures needed to run it. Immutable data and metadata are loaded into initialize-once shared memory. As a result, less memory is required for each session. The class loader attempts to resolve external references when necessary. In addition, if the source files are available, then the class loader calls the Java compiler automatically when Java class files must be recompiled.

1.5.5 Verifier

Java class files are fully portable and conform to a well-defined format. The verifier prevents the inadvertent use of spoofed Java class files, which might alter program flow or violate access restrictions. Oracle security and Java security work with the verifier to protect your applications and data.

1.5.6 Server-Side JDBC Internal Driver

JDBC is a standard and defines a set of Java classes providing vendor-independent access to relational data. The JDBC classes are modeled after ODBC and the X/Open SQL Call Level Interface (CLI) and provide standard features, such as simultaneous connections to several databases, transaction management, simple queries, calls to stored procedures, and streaming access to `LONG` column data.

Using low-level entry points, a specially tuned JDBC driver runs directly inside Oracle Database, providing fast access to Oracle data from Java stored procedures. The server-side JDBC internal driver complies fully with the standard JDBC specification.

Tightly integrated with the database, the JDBC driver supports Oracle-specific data types, globalization character sets, and stored procedures. In addition, the client-side and server-side JDBC APIs are the same, which makes it easy to partition applications.

1.5.7 Server-Side SQLJ Translator

SQLJ enables you to embed SQL statements in Java programs. It is more concise than JDBC and more responsive to static analysis and type checking. The SQLJ preprocessor, which itself is a Java program, takes as input a Java source file in which SQLJ clauses are embedded. Then, it translates the SQLJ clauses into Java class definitions that implement the specified SQL statements. The Java type system ensures that objects of those classes are called with the correct arguments.

A highly optimized SQLJ translator runs directly inside the database, where it provides run-time access to Oracle data using the server-side internal JDBC driver. SQLJ forms can include queries, data manipulation language (DML) statements, data definition language (DDL) statements, transaction control statements, and calls to stored procedures. The client-side and server-side SQLJ APIs are identical, making it easy to partition applications.

1.5.8 System Classes

A set of classes that constitute a significant portion of the implementation of Java in Oracle Database environment is known as the **System classes**. These classes are defined in the `SYS` schema and exported for all users by public synonym. A class with the same name as one of the System classes can be defined in a schema other than the `SYS` schema¹. But, this is a bad practice because the alternate version of the class may behave in a manner that violates assumptions about the semantics of that class that are present in other System classes or in the underlying implementation of Java Virtual Machine. Oracle strongly discourages this practice.

1.6 Java Programming in Oracle Database

Oracle provides enterprise application developers an end-to-end Java solution for creating, deploying, and managing Java applications. The total solution consists of client-side and server-side programmatic interfaces, tools to support Java development, and a JVM integrated with Oracle Database. All these products are fully compatible with Java standards. This section covers the following topics:

- [Java in Database Application Development](#)
- [Java Programming Environment Usage](#)
- [Java Stored Procedures](#)
- [PL/SQL Integration and Oracle RDBMS Functionality](#)
- [Development Tools](#)
- [Internet Protocol Version 6 Support](#)

¹ You cannot always define a class with the same name as one of the System classes. For the classes present in some packages, for example, `java.lang`, such definitions are explicitly prohibited by the code.

1.6.1 Java in Database Application Development

The most important features of Java in database application development are:

- Designing data-bound procedures and functions using Java SE APIs and JDBC.
- Extending the reach and capabilities of the database with standard and third-party Java libraries. For example, accessing third-party databases using their drivers in the database and accessing Hadoop/HDFS.
- Providing flexible partitioning of Java2 Platform, Standard Edition (J2SE) applications for symmetric data access at the JDBC level.
- Bridging SQL and the Java2 Platform, Enterprise Edition (J2EE) world by:
 - Calling out Web components, such as JSP and servlet
 - Bridging SQL and Web Services using Web Service Callouts
- Using an Oracle JVM as ERP Integration Hub.
- Invalidating cache.

1.6.2 Java Programming Environment Usage

In addition to the Oracle JVM, the Java programming environment provides:

- Java stored procedures as the Java equivalent and companion for PL/SQL. Java stored procedures are tightly integrated with PL/SQL. You can call Java stored procedures from PL/SQL packages and PL/SQL procedures from Java stored procedures.
- The JDBC and SQLJ programming interfaces for accessing SQL data.
- Tools and scripts that assist in developing, loading, and managing classes.

The following table helps you decide when to use which Java API:

Type of functionality you need	Java API to use
To have a Java procedure called from SQL, such as a trigger.	Java stored procedures
To call a static, simple SQL statement from a known table with known column names from a Java object.	SQLJ
To call dynamic, complex SQL statements from a Java object.	JDBC

1.6.3 Java Stored Procedures

Java stored procedures are Java programs written and deployed on a server and run from the server, exactly like a PL/SQL stored procedure. You invoke it directly with products like SQL*Plus, or indirectly with a trigger. You can access it from any Oracle Net client, such as OCI and PRO*, or JDBC or SQLJ.

In addition, you can use Java to develop powerful, server-side programs, which can be independent of PL/SQL. Oracle Database provides a complete implementation of the standard Java programming language and a fully compliant JVM.

Related Topics

- [Developing Java Stored Procedures](#)

1.6.4 PL/SQL Integration and Oracle RDBMS Functionality

You can call existing PL/SQL programs from Java and Java programs from PL/SQL. This solution protects and leverages your PL/SQL and Java code and opens up the advantages and opportunities of Java-based Internet computing.

Oracle Database offers two different Java APIs for accessing SQL data, JDBC and SQLJ. Both these APIs are available on the client, and the JDBC API is also available on the server. As a result, you can deploy your applications on the client and server.

The following topics introduce the Java APIs provided by Oracle Database:

- [JDBC Drivers](#)
- [SQLJ](#)

1.6.4.1 JDBC Drivers

JDBC is a database access protocol that enables you to connect to a database and run SQL statements and queries to the database. The core Java class libraries provide the following JDBC APIs: `java.sql` and `javax.sql`. However, JDBC is designed to enable vendors to supply drivers that offer the necessary specialization for a particular database. Oracle provides the following distinct JDBC drivers:

Driver	Description
JDBC Thin driver	You can use the JDBC Thin driver to write pure Java applications and applets that access Oracle SQL data. The JDBC Thin driver is especially well-suited for Web-based applications and applets, because you can dynamically download it from a Web page, similar to any other Java applet.
JDBC OCI driver	The JDBC OCI driver accesses Oracle-specific native code, that is, non-Java code, and libraries on the client or middle tier, providing performance boost compared to the JDBC Thin driver, at the cost of significantly larger size and client-side installation.
JDBC server-side internal driver	Oracle Database uses the server-side internal driver when the Java code runs on the server. It allows Java applications running in the Oracle JVM on the server to access locally defined data, that is, data on the same system and in the same process, with JDBC. It provides a performance boost, because of its ability to use the underlying Oracle RDBMS libraries directly, without the overhead of an intervening network connection between the Java code and SQL data. By supporting the same Java-SQL interface on the server, Oracle Database does not require you to rework code when deploying it.

Related Topics

- [About Utilizing SQLJ and JDBC with Java in the Database](#)

See Also:

Oracle Database JDBC Developer's Guide

1.6.4.2 SQLJ

Oracle has worked with other vendors, including IBM, Tandem, and Sybase, to develop a standard way to embed SQL statements in Java programs called SQLJ. This work has resulted in a new standard, ANSI x.3.135.10-1998, for a simpler and more highly productive programming API than JDBC. A user writes applications to this higher-level API and then uses a preprocessor to translate the program to standard Java source with JDBC calls. At run time, the program can communicate with multi-vendor databases using standard JDBC drivers.

SQLJ provides a simple, but powerful, way to develop client-side applications that access databases from Java. You can use SQLJ in stored procedures and triggers. In addition, you can combine SQLJ programs with JDBC.

The SQLJ translator is a Java program that translates embedded SQL in Java source code to pure JDBC-based Java code.



See Also:

Oracle Database SQLJ Developer's Guide

1.6.5 Development Tools

The introduction of Java in Oracle Database enables you to use several Java IDEs. The adherence of Oracle Database to the Java standards and specifications and the open Internet standards and protocols ensures that your Java programs work successfully, when you deploy them on Oracle Database. Oracle provides many tools or utilities that are written in Java making development and deployment of Java server applications easier. Oracle JDeveloper, a Java IDE provided by Oracle, has many features designed specifically to make deployment of Java stored procedures and EJBs easier. You can download JDeveloper from

<http://www.oracle.com/technetwork/developer-tools/jdev/overview/index.html>

1.6.6 Internet Protocol Version 6 Support

Starting from Oracle Database 11g Release 2, Oracle JVM supports Internet Protocol Version 6 (IPv6) addresses in the URL and machine names of the Java code in the database, which resolve to IPv6 addresses. IPv6 is a new Network layer protocol designed by the Internet Engineering Task Force (IETF) to replace the current version of Internet Protocol, Internet Protocol Version 4 (IPv4). The primary benefit of IPv6 is a large address space, derived from the use of 128-bit addresses. IPv6 also improves upon IPv4 in areas such as routing, network autoconfiguration, security, quality of service, and so on.

The following system properties enable you to configure IPv6 preferences:

java.net.preferIPv4Stack

If IPv6 is available on the operating system, then the underlying native socket will be an IPv6 socket. This enables Java applications to connect to, and accept connections from both IPv4 and IPv6 hosts. If you have an application that has a preference to use

only IPv4 sockets, then you can set this property to `true`. If you set the property to `true`, then it implies that the application will not be able to communicate with IPv6 hosts.

java.net.preferIPv6Addresses

Even if IPv6 is available on the operating system, then for backward compatibility reasons, the addresses are mapped to IPv4. For example, applications that depend on access to only an IPv4 service, benefit from this type of mapping. If you want to change the preferences to use IPv6 addresses over IPv4 addresses, then you can set the `java.net.preferIPv6Addresses` property to `true`. This allows applications to be tested and deployed in environments, where the application is expected to connect to IPv6 services.

Note:

All the new System classes that are required for IPv6 support are loaded when Java is enabled during database initialization. So, if your application does not have any addresses that are included in the software code, then you do not need to change your code to use IPv6 functionality.

1.7 Support for Java 8

Oracle Database 12c Release 2 (12.2.0.1) provides support for Java 8, which enables portability of Java applications and libraries, and compliance with the latest Java standards. Java 8 furnishes Nashorn, a JavaScript engine that enables running JavaScript directly in the database.

Note:

This release of Oracle JVM supports only Java 8. However, because Oracle JVM is a database-resident JVM, some JDK specific features including JavaFX, command line tools, Java tools, GUI interfaces, HotSpot, Mission Control, and so on are not supported in Oracle JVM.

Related Topics

- [Introduction to Nashorn JavaScript Engine](#)

1.8 Memory Model for Dedicated Mode Sessions

Since Oracle Database 10g, the Oracle JVM has a new memory model for sessions that connect to the database through a dedicated server. The basic memory structures associated with Oracle include:

- System Global Area (SGA)

The SGA is a group of shared memory structures, known as SGA components, that contain data and control information for one Oracle Database instance. The

SGA is shared by all server and background processes. Examples of data stored in the SGA include cached data blocks and shared SQL areas.

- Program Global Areas (PGA)

A PGA is a memory region that contains data and control information for a server process. It is nonshared memory created by Oracle when a server process is started. Access to the PGA is exclusive to the server process. There is one PGA for each server process. Background processes also allocate their own PGAs. The total PGA memory allocated for all background and server processes attached to an Oracle instance is referred to as the **aggregate PGA**.

The simplest way to manage memory is to allow the database to automatically manage and tune it for you. To do so, you set only a target memory size initialization parameter (`MEMORY_TARGET`) and a maximum memory size initialization parameter (`MEMORY_MAX_TARGET`), on most platforms. The database then tunes to the target memory size, redistributing memory as needed between the SGA and aggregate PGA. Because the target memory initialization parameter is dynamic, you can change the target memory size at any time without restarting the database. The maximum memory size serves as an upper limit so that you cannot accidentally set the target memory size too high. Because certain SGA components either cannot easily shrink or must remain at a minimum size, the database also prevents you from setting the target memory size too low.



See Also:

Oracle Database Administrator's Guide

2

Java Applications on Oracle Database

Oracle Database runs standard Java applications. However, the Java-integrated Oracle Database environment is different from a typical Java development environment. This chapter describes the basic differences for writing, installing, and deploying Java applications within Oracle Database in the following sections:

- [Database Sessions Imposed on Java Applications](#)
- [Execution Control of Java Applications](#)
- [Java Code_ Binaries_ and Resources Storage](#)
- [About Java Classes Loaded in the Database](#)
- [Preparing Java Class Methods for Execution](#)
- [User Interfaces on the Server](#)
- [Shortened Class Names](#)
- [Class.forName\(\) in Oracle Database](#)
- [About Managing Your Operating System Resources](#)
- [About Using the Runtime.exec Functionality in Oracle Database](#)
- [Managing Your Applications Using JMX](#)
- [Overview of Threading in Oracle Database](#)
- [Shared Servers Considerations](#)

2.1 Database Sessions Imposed on Java Applications

In the Java-integrated Oracle Database, your Java applications exist within the context of a database session. Oracle JVM sessions are entirely analogous to traditional Oracle sessions. Each Oracle JVM session maintains the state of the Java applications accessed by the client across calls within the session.

[Figure 2-1](#) illustrates how each Java client starts a database session as the environment for running Java applications within the database. Each Java database session has a separate garbage collector, session memory, and call memory.

Figure 2-1 Java Environment Within Each Database Session

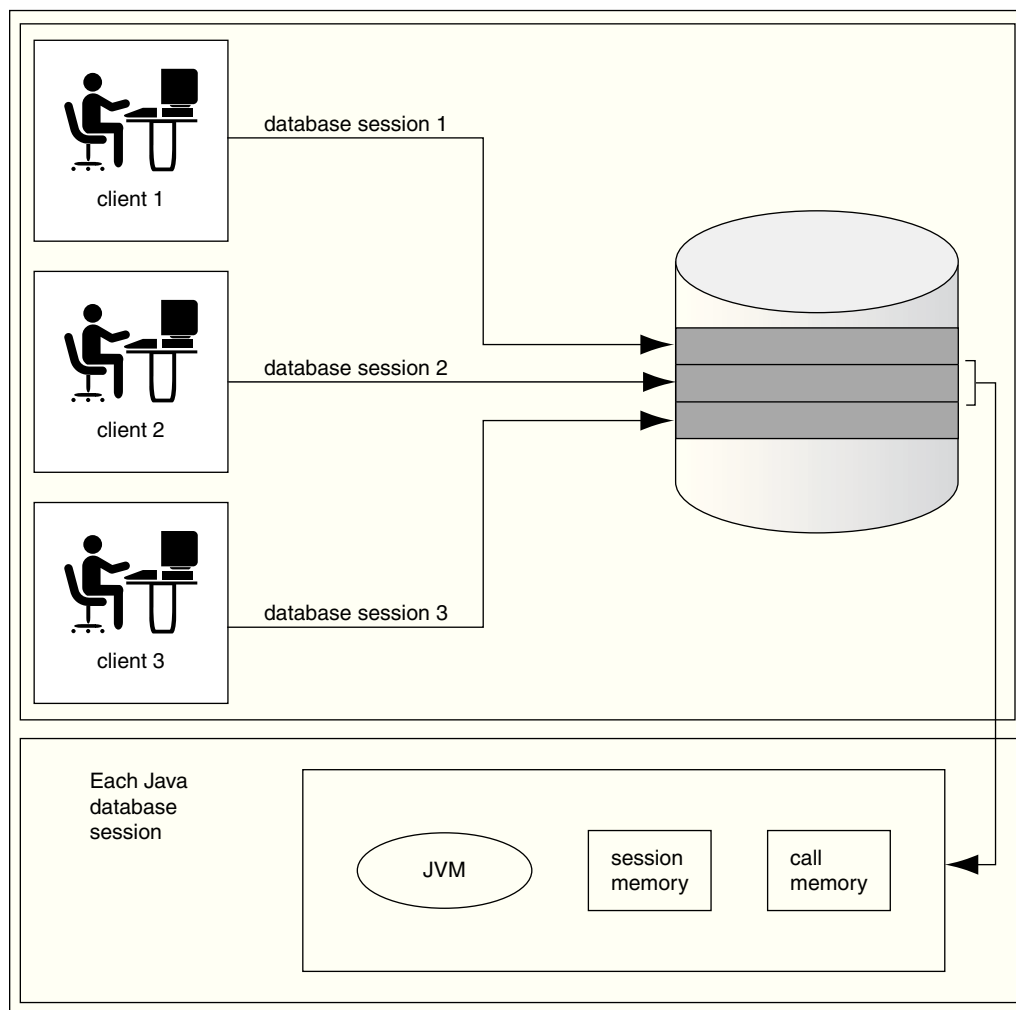

Within the context of a session, the client performs the following:

1. Connects to the database and opens a session.
2. Runs Java within the database. This is referred to as a call.
3. Continues to work within the session, performing as many calls as required.
4. Ends the session.

Within a session, the client has its own Java environment. It appears to the client as if a separate, individual JVM was started for each session, although the implementation is more efficient than this seems to imply. Within a session, Oracle JVM manages the scalability of applications. Every call from a single client is managed within its own session, and calls from each client is handled separately. Oracle JVM maximizes sharing read-only data between clients and emphasizes a minimum amount of per-session incremental footprint, to maximize performance for multiple clients.

The underlying server environment hides the details associated with session, network, state, and other shared resource management issues from the Java code. Fields defined as `static` are local to the client. No client can access the `static` fields of other clients, because the memory is not available across session boundaries.

Because each client runs the Java application calls within its own session, activities of each client are separate from any other client. During a call, you can store objects in `static` fields of different classes, which will be available in the next call. The entire state of your Java program is private and exists for your entire session.

Oracle JVM manages the following within the session:

- All the objects referenced by `static` Java fields, all the objects referred to by these objects, and so on, till their transitive closure
- Garbage collection for the client that created the session
- Session memory for `static` fields and across call memory needs
- Call memory for fields that exist within a call

2.2 Execution Control of Java Applications

In the Java 2 Platform, Standard Edition (J2SE) environment, you develop Java applications with a `main()` method, which is called by the interpreter when the class is run. The `main()` method is called when you enter the following command on the command-line:

```
java classname
```

This command starts the Java interpreter and passes the desired class, that is, the class specified by `classname`, to the Java interpreter. The interpreter loads the class and starts running the application by calling `main()`. However, Java applications within the database do not start by a call to the `main()` method.

After loading your Java application within the database, you can run it by calling any `static` method within the loaded class. The class or methods must be published before you can run them. In Oracle Database, the entry point for Java applications is not assumed to be `main()`. Instead, when you run your Java application, you specify a method name within the loaded class as your entry point.

For example, in a standard Java environment, you would start the Java object on the server by running the following command:

```
java myprogram
```

where, `myprogram` is the name of a class that contains the `main()` method. In `myprogram`, `main()` immediately calls `mymethod()` for processing incoming information.

In Oracle Database, you load the `myprogram.class` file into the database and publish `mymethod()` as an entry-point. Then, the client or trigger can invoke `mymethod()` explicitly.

2.3 Java Code, Binaries, and Resources Storage

In the standard Java development environment, Java source code, binaries, and resources are stored as files in a file system, as follows:

- Source code files are saved as `.java` files.
- Compiled Java binary files are saved as `.class` files.
- Resources are any data files, such as `.properties` or `.ser` files, that are stored in the file system hierarchy and are loaded and used at run time.

In addition, when you run a Java application, you specify the `CLASSPATH`, which is a file or directory path in the file system that contains your `.class` files. Java also provides a way to group these files into a single archive form, a ZIP or Java Archive (JAR) file.

Both these concepts are different in Oracle Database environment.

[Table 2-1](#) describes how Oracle Database handles Java classes and locates dependent classes.

Table 2-1 Description of Java Code and Classes Storage in Oracle Database

Tasks	How it differs for Oracle JVM
Storing Java code, binaries, and resources	In Oracle Database, source code, classes, and resources reside within the database and are known as Java schema objects, where a schema corresponds to a database user. There are three types of Java schema objects: source, class, and resource. There are no <code>.java</code> , <code>.class</code> , <code>.sqlj</code> , <code>.properties</code> , or <code>.ser</code> files on the server. Instead, these files map to the appropriate Java schema objects.
Locating Java classes	Instead of the <code>CLASSPATH</code> , you use a resolver to specify one or more schemas to search for Java source, class, and resource schema objects.

2.4 About Java Classes Loaded in the Database

If you are not using the command-line interface, you must load Java files into the database as schema objects, to make them available to Oracle JVM. The `loadjava` tool can call the Java compiler of Oracle JVM, which compiles source files into standard class files.

The following figure shows that the `loadjava` tool can set the values of options stored in a system database table. Among other things, these options affect the processing of Java source files.

Figure 2-2 Loading Java into Oracle Database

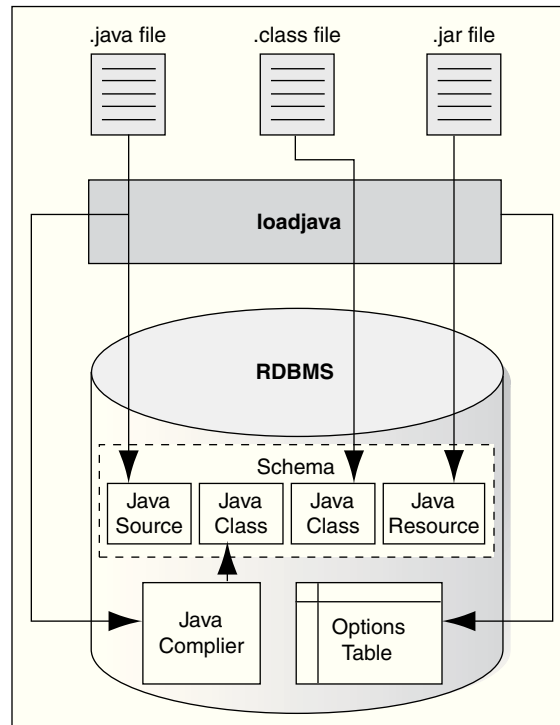

Each Java class is stored as a schema object. The name of the object is derived from the fully qualified name of the class, which includes the names of containing packages. For example, the full name of the class `Handle` is:

```
oracle.aurora.rdbms.Handle
```

In the Java schema object name, slashes replace periods, so the full name of the class becomes:

```
oracle/aurora/rdbms/Handle
```

Oracle Database accepts Java names up to 4000 characters long. However, the names of Java schema objects cannot be longer than 30 characters. Therefore, if a schema object name is longer than 30 characters, then the system generates a short name, or alias, for the schema object. Otherwise, the fully qualified name, also called full name, is used. You can specify the full name in any context that requires it. When needed, name mapping is handled by Oracle Database.

Related Topics

- [About Using the Command-Line Interface](#)
- [Shortened Class Names](#)
- [System Classes](#)

2.5 Preparing Java Class Methods for Execution

To ensure that your Java methods run, you must do the following:

1. Decide when the Java source code is going to be compiled.
2. Decide if you are going to use the default resolver or another resolver for locating supporting Java classes within the database.
3. Load the classes into the database. If you do not wish to use the default resolver for your classes, then you should specify a separate resolver with the load command.
4. Publish your class or method.

This sections covers the following topics:

- [Compiling Java Classes](#)
- [Overview of Resolving Class Dependencies](#)
- [Overview of Loading Classes Using the loadjava Tool](#)
- [Overview of Granting Execute Rights](#)
- [Overview of Controlling the Current User](#)
- [Overview of Checking Java Uploads](#)
- [About Publishing Java Methods Loaded in the Database](#)
- [Overview of Auditing Java Classes Loaded in the Database](#)

2.5.1 Compiling Java Classes

Compilation of the Java source code can be done in one of the following ways:

- You can compile the source explicitly on a client system before loading it into the database, through a Java compiler, such as `javac`.
- You can ask the database to compile the source during the loading process, which is managed by the `loadjava` tool.
- You can force the compilation to occur dynamically at run time.

Note:

If you decide to compile through the `loadjava` tool, then you can specify the compiler options.

This section includes the following topics:

- [Compiling Source Through javac](#)
- [Compiling Source Through the loadjava Tool](#)
- [Compiling Source at Run Time](#)
- [Specifying Compiler Options](#)
- [Recompiling Source Programs Automatically](#)

Related Topics

- [Specifying Compiler Options](#)

2.5.1.1 Compiling Source Through javac

You can compile Java source code with a conventional Java compiler as shown in the following example:

```
javac <file_name>.java
```

After compilation, you load the compiled binary into the database, rather than the source itself. This is a better option, because it is usually easier to debug the Java code on your own system, rather than debugging it on the database.

2.5.1.2 Compiling Source Through the loadjava Tool

When you specify the `-resolve` option with the `loadjava` tool for a source file, the following occurs:

1. The source file is loaded as a source schema object.
2. The source file is compiled.
3. Class schema objects are created for each class defined in the compiled `.java` file.
4. The compiled code is stored in the class schema objects.

Oracle Database writes all compilation errors to the log file of the `loadjava` tool as well as the `USER_ERRORS` view.

2.5.1.3 Compiling Source at Run Time

When you load the Java source into the database without the `-resolve` option, for example:

```
loadjava <file_name>.java
```

Then, Oracle Database compiles the source automatically when the class is needed during run time. The source file is loaded into a source schema object. Oracle Database writes all compilation errors to the log file of the `loadjava` tool as well as the `USER_ERRORS` view.

2.5.1.4 Specifying Compiler Options

You can specify the compiler options in the following ways:

- Specify compiler options on the command line with the `loadjava` tool. You can also specify the encoding option with the `loadjava` tool.
- Specify persistent compiler options in the `JAVA$OPTIONS` table. The `JAVA$OPTIONS` table exists for each schema. Every time you compile, the compiler uses these options. However, any compiler options specified with the `loadjava` tool override the options defined in this table. You must create this table yourself if you wish to specify compiler options in this manner.

2.5.1.4.1 Specifying Default Compiler Options

When compiling a source schema object for which neither a `JAVA$OPTIONS` entry exists nor a command-line value for any option is specified, the compiler assumes a default value as follows:

- `encoding=System.getProperty("file.encoding");`
- `online=true`

This option applies only to Java sources that contain SQLJ constructs.

- `debug=true`

This option is equivalent to:

```
javac -g
```

2.5.1.4.2 Specifying Compiler Options on the Command Line

The `encoding` compiler option specified with the `loadjava` tool identifies the encoding of the `.java` file. This option overrides any matching value in the `JAVA$OPTIONS` table. The values are identical to:

```
javac -encoding
```

This option is relevant only when loading a source file.

2.5.1.4.3 Specifying Compiler Options Specified in a Database Table

Each `JAVA$OPTIONS` entry contains the names of source schema objects to which an option setting applies. You can use multiple rows to set the options differently for different source schema objects.

You can set `JAVA$OPTIONS` entries by using the following procedures and functions, which are defined in the database package `DBMS_JAVA`:

```
PROCEDURE set_compiler_option(name VARCHAR2, option VARCHAR2, value VARCHAR2);
```

```
FUNCTION get_compiler_option(name VARCHAR2, option VARCHAR2) RETURNS VARCHAR2;
```

```
PROCEDURE reset_compiler_option(name VARCHAR2, option VARCHAR2);
```

2.5.1.4.4 Details About Specifying Compiler Options Specified in the Database Table

The following table describes the parameters for the methods described in the preceding section.

Table 2-2 Definitions for the Name and Option Parameters

Parameter	Description
name	This is a Java package name, a fully qualified class name, or an empty string. When the compiler searches the JAVA\$OPTIONS table for the options to use for compiling a Java source schema object, it uses the row that has a value for name that most closely matches the fully qualified class name of a schema object. A name whose value is the empty string matches any schema object name.
option	The option parameter is either online, encoding, or debug.

Initially, a schema does not have a JAVA\$OPTIONS table. To create a JAVA\$OPTIONS table, use the `java.set_compiler_option` procedure from the `DBMS_JAVA` package to set a value. The procedure will create the table, if it does not exist. Specify parameters in single quotes. For example:

```
SQL> execute dbms_java.set_compiler_option('x.y', 'online', 'false');
```

The following table represents a hypothetical JAVA\$OPTIONS database table. The pattern match rule is to match as much of the schema name against the table entry as possible. The schema name with a higher resolution for the pattern match is the entry that applies. Because the table has no entry for the `encoding` option, the compiler uses the default or the value specified on the command line. The `online` option shown in the table matches schema object names as follows:

- The name `a.b.c.d` matches class and package names beginning with `a.b.c.d`. The packages and classes are compiled with `online=true`.
- The name `a.b` matches class and package names beginning with `a.b`. The name `a.b` does not match `a.b.c.d`. The packages and classes are compiled with `online=false`.
- All other packages and classes match the empty string entry and are compiled with `online=true`.

Table 2-3 Example JAVA\$OPTIONS Table

Name	Option	Value	Match Examples
a.b.c.d	online	true	<ul style="list-style-type: none"> • a.b.c.d Matches the pattern exactly. • a.b.c.d.e First part matches the pattern exactly. No other rule matches the full qualified name.
a.b	online	false	<ul style="list-style-type: none"> • a.b Matches the pattern exactly • a.b.c.x First part matches the pattern exactly. No other rule matches beyond this rule.

Table 2-3 (Cont.) Example JAVA\$OPTIONS Table

Name	Option	Value	Match Examples
Empty string	online	true	<ul style="list-style-type: none"> a.c No pattern match with any defined name. Defaults to the empty string rule. x.y No pattern match with any defined name. Defaults to the empty string rule.

2.5.1.5 Recompiling Source Programs Automatically

Oracle Database provides a dependency management and automatic build facility that transparently recompiles source programs when you make changes to the source or binary programs upon which they depend. Consider the following example:

```
public class A
{
    B b;
    public void assignB()
    {
        b = new B()
    }
}
public class B
{
    C c;
    public void assignC()
    {
        c = new C()
    }
}
public class C
{
    A a;
    public void assignA()
    {
        a = new A()
    }
}
```

The system tracks dependencies at a class level of granularity. In the preceding example, you can see that classes A, B, and C depend on one another, because A holds an instance of B, B holds an instance of C, and C holds an instance of A. If you change the definition of class A by adding a new field to it, then the dependency mechanism in Oracle Database flags classes B and C as invalid. Before you use any of these classes again, Oracle Database attempts to resolve them and recompile, if necessary. Note that classes can be recompiled only if the source file is present on the server.

The dependency system enables you to rely on Oracle Database to manage dependencies between classes, to recompile, and to resolve automatically. You must force compilation and resolution yourself only if you are developing and you want to

find problems early. The `loadjava` tool also provides the facilities for forcing compilation and resolution if you do not want the dependency management facilities to perform this for you.

2.5.2 Overview of Resolving Class Dependencies

Many Java classes contain references to other classes, which is the essence of reusing code. A conventional JVM searches for `.class`, `.zip`, and `.jar` files within the directories specified in `CLASSPATH`. In contrast, Oracle JVM searches database schemas for class objects. In Oracle Database, because you load all Java classes into the database, you may need to specify where to find the dependent classes for your Java class within the database.

All classes loaded within the database are referred to as class schema objects and are loaded within certain schemas. All predefined Java application programming interfaces (APIs), such as `java.lang.*`, are loaded within the `PUBLIC` schema. If your classes depend on other classes you have defined, then you will probably load them all within your own schema. For example, if your schema is `HR`, then the database resolver searches the `HR` schema before searching the `PUBLIC` schema. The listing of schemas to search is known as a **resolver specification**. Resolver specifications are defined for each class. This is in contrast to a classic JVM, where `CLASSPATH` is global to all classes.

When locating and resolving the interclass dependencies for classes, the resolver marks each class as valid or invalid, depending on whether all interdependent classes are located. If the class that you load contains a reference to a class that is not found within the appropriate schemas, then the class is listed as invalid. Unsuccessful resolution at run time produces a `ClassNotFoundException` exception. Also, run-time resolution can fail for lack of database resources, if the tree of classes is very large.

 **Note:**

As with the Java compiler, the `loadjava` tool resolves references to classes, but not to resources. Ensure that you correctly load the resource files that your classes require.

For each interclass reference in a class, the resolver searches the schemas specified by the resolver specification for a valid class schema object that satisfies the reference. If all references are resolved, then the resolver marks the class valid. A class that has never been resolved, or has been resolved unsuccessfully, is marked invalid. A class that depends on a schema object that becomes invalid is also marked invalid.

To make searching for dependent classes easier, Oracle Database provides a default resolver and resolver specification that searches the definer's schema first and then searches the `PUBLIC` schema. This covers most of the classes loaded within the database. However, if you are accessing classes within a schema other than your own or `PUBLIC`, you must define your own resolver specification.

Classes can be resolved in the following ways:

- Loading using the default resolver, which searches the definer's schema and `PUBLIC`:

```
loadjava -resolve
```

- Loading using your own resolver specification definition:

```
loadjava-resolve -resolver "((* HR)(* OTHER)(* PUBLIC))"
```

In the preceding example, the resolver specification definition includes the `HR` schema, `OTHER` schema, and `PUBLIC`.

The `-resolver` option specifies the objects to search within the schemas defined. In the preceding example, all class schema objects are searched within `HR`, `OTHER`, and `PUBLIC`. However, if you want to search for only a certain class or group of classes within the schema, then you could narrow the scope for the search. For example, to search only for the `my/gui/*` classes within the `OTHER` schema, you would define the resolver specification as follows:

```
loadjava -resolve -resolver '((* HR) ("my/gui/*" OTHER) (* PUBLIC))'
```

The first parameter within the resolver specification is for the class schema object, and the second parameter defines the schema within which to search for these class schema objects.

2.5.2.1 Allowing References to Nonexistent Classes

You can specify a special option within a resolver specification that allows an unresolved reference to a nonexistent class. Sometimes, internal classes are never used within a product. In a standard Java environment, this is not a problem, because as long as the methods are not called, JVM ignores them. However, when resolving a class, Oracle JVM tries to resolve all names referenced by that class, including names that may never be used. If Oracle JVM cannot find a matching class for each such names referenced by that class, then the class being resolved is marked as invalid and cannot be run.

To ignore references, you can specify the wildcard, minus sign (`-`), within the resolver specification. The following example specifies that any references to classes within `my/gui` are to be allowed, even if it is not present within the resolver specification schema list.

```
loadjava -resolve -resolver '((* HR) (* PUBLIC) ("my/gui/*" -))'
```

Without the wildcard, if a dependent class is not found within one of the schemas, your class is listed as invalid and cannot be run.

In addition, you can define that all classes not found are to be ignored. However, this is dangerous, because a class that has a dependent class will be marked as valid, even if the dependent class does not exist. However, the class can never run without the dependent class. In this case, you will receive an exception at run time.

To ignore all classes not found within `HR` or `PUBLIC`, specify the following resolver specification:

```
loadjava -resolve -resolver "((* HR) (* PUBLIC) (* -))"
```

If you later intend to load the nonexistent classes that required you to use such a resolver, then you should not use a resolver containing the minus sign (`-`) wildcard. Instead, include all referenced classes in the schema before resolving.

Even when a minus sign (-) wildcard is used, the super class of a class can never be nonexistent. If the super class is not found, then the class will be invalid regardless of the use of a minus sign (-) wildcard in the resolver.

 **Note:**

An alternative mechanism for dealing with nonexistent classes is using the `-gemissing` option of the `loadjava` tool. This option causes the `loadjava` tool to create and load definitions of classes that are referenced, but not defined.

2.5.2.2 Bytecode Verifier

According to JVM specification, `.class` files are subject to verification before the class they define is available in a JVM. In Oracle JVM, the verification process occurs at class resolution.

The following table describes the problems the resolver may find and the appropriate Oracle error code issued.

Table 2-4 ORA Errors

Error Code	Description
ORA-29545	<p>If the resolver determines that the class is malformed, then the resolver does not mark it valid. When the resolver rejects a class, it issues an ORA-29545 error. The <code>loadjava</code> tool reports the error. For example, this error is thrown if the contents of a <code>.class</code> file are not the result of a Java compilation or if the file has been corrupted.</p> <p>The ORA-29545 error may also show up if you used the minus sign (-) wild card expression with the resolver and the validity of some classes was not verified.</p>
ORA-29552	<p>In some situations, the resolver allows a class to be marked valid, but will replace bytecodes in the class to throw an exception at run time. In these cases, the resolver issues an ORA-29552 warning that the <code>loadjava</code> tool reports. The <code>loadjava</code> tool issues this warning when the Java Language Specification (JLS) requires an <code>IncompatibleClassChangeError</code> to be thrown. Oracle JVM relies on the resolver to detect these situations, supporting the proper run-time behavior that the JLS requires.</p>

A resolver with the minus sign (-) wildcard marks your class valid, regardless of whether classes referenced by your class are present. Because of inheritance and interfaces, you may want to write valid Java methods that use an instance of a class as if it were an instance of a superclass or of a specific interface. When the method being verified uses a reference to class `A` as if it were a reference to class `B`, the resolver must check that `A` either extends or implements `B`. For example, consider the following potentially valid method, whose signature implies a return of an instance of `B`, but whose body returns an instance of `A`:

```
B myMethod(A a)
{
```



```
    return a;  
}
```

The method is valid only if `A` extends the class `B` or `A` implements the interface `B`. If `A` or `B` have been resolved using the minus sign (-) wildcard, then the resolver does not know that this method is safe. In this case, the resolver replaces the bytecodes of `myMethod` with bytecodes that throw an exception if `myMethod` is called.

A resolver without the minus sign (-) wildcard ensures that the class definitions of `A` and `B` are found and resolved properly if they are present in the schemas they specifically identify. The only time you may consider using the alternative resolver is if you must load an existing JAR file containing classes that reference other nonsystem classes, which are not included in the JAR file.

Related Topics

- [Schema Objects and Oracle JVM Utilities](#)

2.5.3 Logging in Oracle JVM

Oracle JVM extends the JDK Java Logging API in the area of logging properties lookup to enhance security of logging configuration management and to support logging configurations on a user basis.



See Also:

For more information about Java Logging APIs, visit the following site:

<http://docs.oracle.com/javase/7/docs/>

You must activate the `LogManager` in the session to initialize the logging properties in Oracle JVM. The logging properties are initialized once per session with the `LogManager` API that is extended with the database resident resource lookup.

Oracle JVM performs the following steps to configure logging options:

1. If the `java.util.logging.config.class` property is set, then the logging behavior is the same as in standard JDK.
2. If the `java.util.logging.config.class` property is not set, then Oracle JVM inspects the availability of the `javavm/lib/logging.properties` resource in the current user schema.

If available, this resource is used as the configuration setting for the `LogManager` and the `java.util.logging.config.file` property is set.

3. If both the above conditions do not hold true, then the `java.util.logging.config.file` property is inspected and if specified, it is used as described in `LogManager` API.
4. If none of the conditions in step 1, 2, and 3 holds true, then the `javavm/lib/logging.properties` resource in the `SYS` schema is used. This resource is a copy of the `$(java.home)/lib/logging.properties` file that is loaded into the `SYS` schema at database creation time. This means, by default, the `LogManager` behaves as if it is configured as per the `$(java.home)/javavm/lib/`

logging.properties file. However, altering this file has no effect until the database is re-created

If you are not satisfied with the default settings in the `javavm/lib/logging.properties` file, then prepare a different set of properties and load them in your schema using the `loadjava` command. For example, if your schema is `HR` and your current file directory is `mydir`, then create a directory `javavm/lib/` under `mydir` and specify the required properties in the `logging.properties` file under the `mydir/javavm/lib/` directory. Then, invoke the `loadjava` command from `mydir` as follows:

```
mydir% loadjava -u HR -v -r javavm/lib/logging.properties
password:<password>
```

After invoking the `loadjava` command, you can delete the `mydir/javavm/lib/logging.properties` file. Any session running as `HR` and performing activation of `LogManager` will have the `LogManager` configured with properties coming from this database resident resource private to `HR`.

 **Note:**

Oracle JVM always runs with a security manager. So, `HR` must be granted logging permissions, regardless of the logging configuration method used. In most cases, the following call issued by a privileged user is sufficient to grant these permissions:

```
call dbms_java.grant_permission( 'HR',
'SYS:java.util.logging.LoggingPermission', 'control', '' );
```

2.5.4 Overview of Loading Classes Using the `loadjava` Tool

You can use the `loadjava` tool to create schema objects from files and load the schema objects to different schemas. For example,

```
loadjava -u HR -schema TEST MyClass.java
Password: password
```

 **Note:**

You do *not* have to load the classes to the database as schema objects if you use the command-line interface. For example,

```
C:\oraclehome\bin>loadjava -u HR MyClass.java
Password: password
```

You can also run the `loadjava` tool from within SQL commands. Unlike a conventional JVM, which compiles and loads from files, Oracle JVM compiles and loads from database schema objects.

The following table describes database schema objects that correspond to the files used by a conventional JVM.

Table 2-5 Description of Java Files

Java File Types	Description
.java source files or .sqlj source files	correspond to Java source schema objects
.class compiled Java files	correspond to Java class schema objects
.properties Java resource files, .ser SQLJ profile files, or data files	correspond to Java resource schema objects

You must load all classes or resources into the database to be used by other classes within the database. In addition, at load time, you define who can run your classes within the database.

The following table describes the activities the `loadjava` tool performs for each type of file.

Table 2-6 loadjava Operations on Schema Objects

Schema Object	loadjava Operations on Objects
.java source files	<ol style="list-style-type: none"> 1. Creates a Java source schema object in the definer's schema unless another schema is specified. 2. Loads the contents of the source file into a schema object. 3. Creates a class schema object for all classes defined in the source file. 4. If <code>-resolve</code> is requested, compiles the source schema object and resolves the class and its dependencies. It then stores the compiled class into a class schema object.
.sqlj source files	<ol style="list-style-type: none"> 1. Creates a source schema object in the definer's schema unless another schema is specified. 2. Loads contents of the source file into the schema object. 3. Creates a class schema object for all classes and resources defined in the source file. 4. If <code>-resolve</code> is requested, translates and compiles the source schema object and stores the compiled class into a class schema object. It then stores the profile into a <code>.ser</code> resource schema object and customizes it.
.class compiled Java files	<ol style="list-style-type: none"> 1. Creates a class schema object in the definer's schema unless another schema is specified. 2. Loads the class file into the schema object. 3. Resolves and verifies the class and its dependencies if <code>-resolve</code> is specified.
.properties Java resource files	<ol style="list-style-type: none"> 1. Creates a resource schema object in the definer's schema unless another schema is specified. 2. Loads a resource file into a schema object.

Table 2-6 (Cont.) loadjava Operations on Schema Objects

Schema Object	loadjava Operations on Objects
.ser SQLJ profile	<ol style="list-style-type: none"> 1. Creates a resource schema object in the definer's schema unless another schema is specified. 2. Loads the .ser resource file into a schema object and customizes it.

 **Note:**

The `dropjava` tool performs the reverse of the `loadjava` tool. It deletes schema objects that correspond to Java files. Always use the `dropjava` tool to delete a Java schema object created with the `loadjava` tool. For example,

```
dropjava -u HR -schema TEST MyClass.java
Password: password
```

Dropping with SQL data definition language (DDL) commands will not update the auxiliary data maintained by the `loadjava` tool and the `dropjava` tool. You can also run the `dropjava` tool from within SQL commands.

After loading the classes and resources, you can access the `USER_OBJECTS` view in your database schema to verify whether your classes and resources have been loaded properly.

Related Topics

- [Schema Objects and Oracle JVM Utilities](#)

Related Topics

- [About Using the Command-Line Interface](#)

2.5.4.1 About Sharing of Metadata for User Classloaded Classes

Classes loaded by the built-in mechanism for loading database resident classes are known as **system classloaded**, whereas those loaded by other means are called **user classloaded**. When you load a class into the database, a representation of the class is created in memory, part of which is referred to here as the class metadata. The class metadata is the same for any session using the class and is potentially sharable. Earlier, such sharing was available only for system classloaded classes. Since Oracle Database 11g, you can also share class metadata of user classloaded classes, at the discretion of the system administrator.

Related Topics

- [Classpath Extensions and User Classloaded Metadata](#)

2.5.4.2 Defining the Same Class Twice

You cannot have two class objects with the same name in the same schema. This rule affects you in two ways:

 **Note:**

An exception to this rule is when you use the `-prependjarnames` option for database resident JARs. If you use this option, then you can have two classes with the same class name in the same schema.

- You can load either a particular Java `.class` file or its `.java` file, but not both.
Oracle Database tracks whether you loaded a class file or a source file. If you want to update the class, then you must load the same type of file that you originally loaded. If you want to update the other type, then you must drop the first before loading the second. For example, if you loaded `x.java` as the source for class `y`, then to load `x.class`, you must first drop `x.java`.
- You cannot define the same class within two different schema objects in the same schema. For example, suppose `x.java` defines class `y` and you want to move the definition of `y` to `z.java`. If `x.java` has already been loaded, then the `loadjava` tool rejects any attempt to load `z.java`, which also defines `y`. Instead, do either of the following:
 - Drop `x.java`, load `z.java`, which defines `y`, and then load the new `x.java`, which does not define `y`.
 - Load the new `x.java`, which does not define `y`, and then load `z.java`, which defines `y`.

Related Topics

- [Database Resident JARs](#)

2.5.4.3 About Designating Database Privileges and JVM Permissions

You must have the following SQL database privileges to load classes:

- `CREATE PROCEDURE` and `CREATE TABLE` privileges to load into your schema.
- `CREATE ANY PROCEDURE` and `CREATE ANY TABLE` privileges to load into another schema.
- `oracle.aurora.security.JServerPermission.loadLibraryInClass.className`.

Related Topics

- [Permission for Loading Classes](#)

2.5.4.4 About Loading JAR or ZIP Files

The `loadjava` tool accepts `.class`, `.java`, `.properties`, `.sqlj`, `.ser`, `.jar`, or `.zip` files. The JAR or ZIP files can contain source, class, and data files. When you pass a JAR or ZIP file to the `loadjava` tool, it opens the archive and loads the members of the archive individually. There is no JAR or ZIP schema object. If the JAR or ZIP content has not changed since the last time it was loaded, then it is not reloaded. Therefore, there is little performance penalty for loading JAR or ZIP files. In fact, loading JAR or ZIP files is the simplest way to use the `loadjava` tool.

 **Note:**

Oracle Database does not reload a class if it has not changed since the last load. However, you can force a class to be reloaded using the `-force` option.

2.5.4.5 Database Resident JARs

Starting with 11g release 1 (11.1), when you load the contents of a JAR into the database, you have the option of creating a database object representing the JAR itself. In this way, you can retain an association between this JAR object and the class, resource, and source objects loaded from the JAR. This enables you to:

- Use signed JARs and JAR namespace segregation in the same way as you use them in standard JVM.
- Manage the classes that you have derived from a JAR while loading it into the database as a single unit. This helps you to prevent individual redefinition of the classes loaded from the JAR. It also enables you to drop the whole set of classes loaded from the JAR, irrespective of the contents or the continued existence of the JAR on the external file system, at the time of dropping it.

In order to load a JAR into the database, you have the following options of the `loadjava` tool:

- `-jarsasdbobjects`
- `-prependjarnames`

Related Topics

- [The `loadjava` Tool](#)

2.5.5 Overview of Granting Execute Rights

If you load all classes within your own schema and do not reference any class outside your schema, then you already have rights to run the classes. You have the privileges necessary for your objects to call other objects loaded in the same schema. That is, the ability for class A to call class B. Class A must be given the right to call class B.

The classes that define a Java application are stored within Oracle Database under the SQL schema of their owner. By default, classes that reside in one user's schema cannot be run by other users, because of security concerns. You can provide other users the right to run your class in the following ways:

- Using the `loadjava -grant` option
- Using the following command:

```
SQL> grant execute on myclass to HR;
```

where, `myclass` is the name of the underlying Java class.

 **Note:**

Prior to Oracle Database 11g release 1 (11.1), granting execute right to a stored procedure meant granting execute right to both the stored procedure and the Java class referred by the stored procedure. Since Oracle Database 11g release, if you want to grant execute right on the underlying Java class as well, then you must grant execute right on the class explicitly. This is implemented for better security.

The following figure illustrates the rights required to run classes.

Figure 2-3 Rights to Run Classes

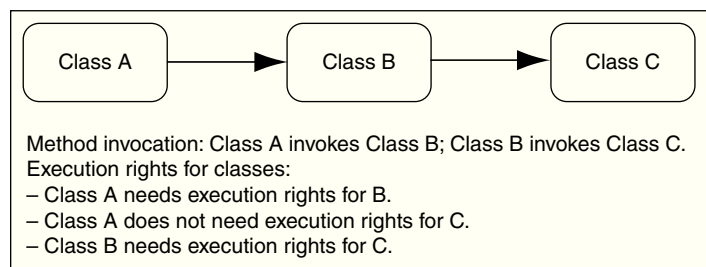
**Related Topics**

- [The loadjava Tool](#)

Related Topics

- [Oracle Database Java Application Performance](#)

2.5.6 Overview of Controlling the Current User

During the execution of PL/SQL code, there is always a current user. The same concept is used for the execution of Java code. Initially, the current user is the user, who creates the session that invokes the Java code. A Java method is called from SQL or PL/SQL through a corresponding wrapper. Java wrappers are special PL/SQL entities, which expose Java methods to SQL and PL/SQL as PL/SQL stored procedures or functions. Such a wrapper might change the current effective user. The wrappers that change the current effective user to the owner of the wrapper are called definer's rights wrappers. If a wrapper does not change the current effective user, then the effective user remains unchanged.

By default, Java wrappers are definer's rights wrappers. If you want to override this, then create the wrapper using the `AUTHID CURRENT_USER` option.

At any time during the execution of Java code, a Java call stack is maintained. The stack contains frames corresponding to Java methods entered, with the innermost frame corresponding to the currently executing method. By default, Java methods execute on the stack without changing the current user, that is, with the privileges of their current effective invoker, not their definer.

You can load a Java class to the database with the `loadjava -definer` option. Any method of a class having the definer attribute marked, becomes a definer's rights

method. When such a method is entered, a special kind of frame called a definer's frame is created onto the Java stack. This frame switches the current effective user to the owner (definer) of such a class. A new user ID remains effective for all inner frames until either the definer's frame is popped off the stack or a nested definer's frame is entered.

Thus, at any given time during the execution of a Java method that is called from SQL or PL/SQL through its wrapper, the effective user is one of the following:

- The innermost definer's frame on the Java stack
- Either the owner of the PL/SQL wrapper of the topmost Java method, if it is definer's rights, or the user who called the wrapper.

Consider a company that uses a definer's rights procedure to analyze sales. To provide local sales statistics, the procedure `analyze` must access `sales` tables that reside at each regional site. To do this, the procedure must also reside at each regional site. This causes a maintenance problem. To solve the problem, the company installs an invoker's rights version of the procedure `analyze` at headquarters.

The following figure shows how all regional sites can use the same procedure to query their own `sales` tables.

Figure 2-4 Invoker's rights Solution

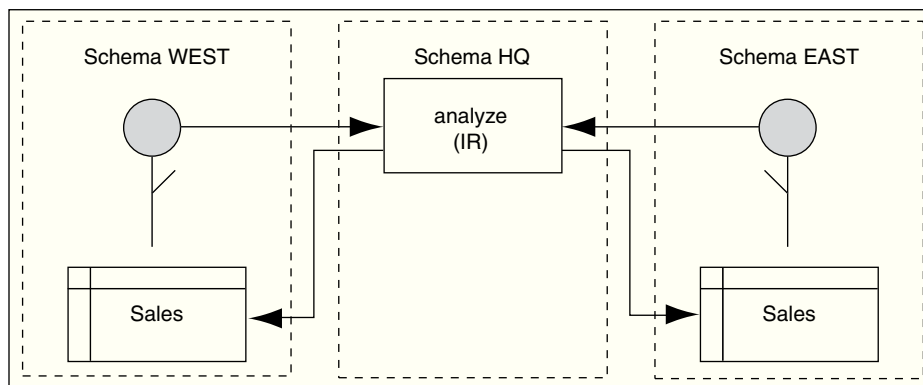

Occasionally, you may want to override the default invoker's rights behavior. Suppose headquarters wants the `analyze` procedure to calculate sales commissions and update a central `payroll` table. This presents a problem, because invokers of `analyze` should not have direct access to the `payroll` table, which stores employee salaries and other sensitive data.

The following figure illustrates the solution, where the `analyze` procedure calls the definer's rights procedure, `calcComm`, which in turn updates the `payroll` table.

Figure 2-5 Indirect Access

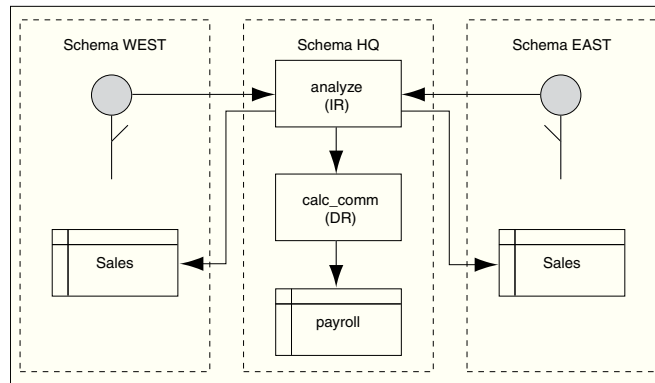

Related Topics

- [Writing Top-Level Call Specifications](#)

2.5.7 Overview of Checking Java Uploads

You can query the `USER_OBJECTS` database view to obtain information about schema objects that you own, including Java sources, classes, and resources. This enables you, for example, to verify whether sources, classes, or resources that you load are properly stored in schema objects.

The following table lists the key columns in `USER_OBJECTS` and their description.

Table 2-7 Key `USER_OBJECTS` Columns

Name	Description
<code>OBJECT_NAME</code>	Name of the object
<code>OBJECT_TYPE</code>	Type of the object, such as <code>JAVA SOURCE</code> , <code>JAVA CLASS</code> , or <code>JAVA RESOURCE</code> .
<code>STATUS</code>	Status of the object. The values can be either <code>VALID</code> or <code>INVALID</code> . It is always <code>VALID</code> for <code>JAVA RESOURCE</code> .

Object Name and Type

An `OBJECT_NAME` in `USER_OBJECTS` is the alias. The fully qualified name is stored as an alias if it exceeds 30 characters.

If the server uses an alias for a schema object, then you can use the `LONGNAME()` function of the `DBMS_JAVA` package to receive it from a query as a fully qualified name, without having to know the alias or the conversion rules.

```
SQL> SELECT dbms_java.longname(object_name) FROM user_objects WHERE
object_type='JAVA SOURCE';
```

This statement displays the fully qualified name of the Java source schema objects. Where no alias is used, no conversion occurs.

 **Note:**

SQL and PL/SQL are *not* case-sensitive.

You can use the `SHORTNAME()` function of the `DBMS_JAVA` package to use a fully qualified name as a query criterion, without having to know whether it was converted to an alias in the database.

```
SQL*Plus> SELECT object_type FROM user_objects WHERE
object_name=dbms_java.shortname('known_fullname');
```

This statement displays the `OBJECT_TYPE` of the schema object with the specified fully qualified name. This presumes that the fully qualified name is representable in the database character set.

```
SQL> select * from javasnm;
SHORT LONGNAME
-----
/78e6d350_BinaryExceptionHandl sun/tools/java/BinaryExceptionHandler
/b6c774bb_ClassDeclaration sun/tools/java/ClassDeclaration
/af5a8ef3_JarVerifierStream1 sun/tools/jar/JarVerifierStream$1
```

This statement displays all the data stored in the `jvasnm` view.

Status

`STATUS` is a character string that indicates the validity of a Java schema object. A Java source schema object is `VALID` if it compiled successfully, and a Java class schema object is `VALID` if it was resolved successfully. A Java resource schema object is always `VALID`, because resources are not resolved.

Example: Accessing USER_OBJECTS

The following SQL*Plus script accesses the `USER_OBJECTS` view to display information about uploaded Java sources, classes, and resources:

```
COL object_name format a30
COL object_type format a15
SELECT object_name, object_type, status
       FROM user_objects
       WHERE object_type IN ('JAVA SOURCE', 'JAVA CLASS', 'JAVA RESOURCE')
       ORDER BY object_type, object_name;
```

You can optionally use wildcards in querying `USER_OBJECTS`, as in the following example:

```
SELECT object_name, object_type, status
       FROM user_objects
       WHERE object_name LIKE '%Alerter';
```

The preceding statement finds any `OBJECT_NAME` entries that end with the characters `Alerter`.

Related Topics

- [Shortened Class Names](#)

2.5.8 About Publishing Java Methods Loaded in the Database

Oracle Database enables clients and SQL to call Java methods that are loaded in the database after they are published. You publish either the object itself or individual methods. If you write a Java stored procedure that you intend to call with a trigger, directly or indirectly in SQL data manipulation language (DML) or in PL/SQL, then you must publish individual methods in the class. Using a call specification, specify how to access the method. Java programs consist of many methods in many classes. However, only a few `static` methods are typically exposed with call specifications.

Related Topics

- [Publishing Java Classes With Call Specifications](#)

2.5.9 Overview of Auditing Java Classes Loaded in the Database

In releases prior to Oracle Database 10g release 2 (10.2), Java classes in the database cannot be audited directly. However, you can audit the PL/SQL wrapper. Typically, all Java stored procedures are started from some wrappers. Therefore, all Java stored procedures can be audited, though not directly.

Since Oracle Database 10g release 2 (10.2), you can audit DDL statements for creating, altering, or dropping Java source, class, and resource schema objects, as with any other DDL statement. Oracle Database provides auditing options for auditing Java activities easily and directly. You can also audit any modification of Java sources, classes, and resources.

You can audit database activities related to Java schema objects at two different levels, statement level and object level. At the statement level you can audit all activities related to a special pattern of statements.

[Table 2-8](#) lists the statement auditing options and the corresponding SQL statements related to Java schema objects.

Table 2-8 Statement Auditing Options Related to Java Schema Objects

Statement Option	SQL Statements
CREATE JAVA SOURCE	CREATE JAVA SOURCE CREATE OR REPLACE JAVA SOURCE
ALTER JAVA SOURCE	ALTER JAVA SOURCE
DROP JAVA SOURCE	DROP JAVA SOURCE
CREATE JAVA CLASS	CREATE JAVA CLASS CREATE OR REPLACE JAVA CLASS
ALTER JAVA CLASS	ALTER JAVA CLASS
DROP JAVA CLASS	DROP JAVA CLASS
CREATE JAVA RESOURCE	CREATE JAVA RESOURCE CREATE OR REPLACE JAVA RESOURCE
ALTER JAVA RESOURCE	ALTER JAVA RESOURCE
DROP JAVA RESOURCE	DROP JAVA RESOURCE

For example, if you want to audit the `ALTER JAVA SOURCE DDL` statement, then enter the following statement at the SQL prompt:

```
AUDIT ALTER JAVA SOURCE
```

Object level auditing provides finer granularity. It enables you to identify specific problems by zooming into specific objects.

[Table 2-9](#) lists the object auditing options for each Java schema object. The entry X in a cell indicates that the corresponding SQL command can be audited for that Java schema object. The entry NA indicates that the corresponding SQL command is not applicable for that Java schema object.

Table 2-9 Object Auditing Options Related to Java Schema Options

Object Option	Java Source	Java Resource	Java Class
ALTER	X	NA	X
EXECUTE	NA	NA	X
AUDIT	X	X	X
GRANT	X	X	X

See Also:

- *Oracle Database Security Guide*
- *Oracle Database SQL Language Reference*

2.6 User Interfaces on the Server

Oracle Database furnishes all core Java class libraries on the server, including those associated with presentation of the user interfaces. However, it is inappropriate for code running on the server to attempt to materialize or display a user interface on the server. Users running applications in Oracle JVM environment should not be expected nor allowed to interact with or depend on the display and input hardware of the server where Oracle Database is running.

To address compatibility issues on platforms that do not support display, keyboard, or mouse, Java 1.4 outlines Headless Abstract Window Toolkit (AWT) support. The Headless AWT API introduces a new `public` run-time exception class, `java.awt.HeadlessException`. The constructors of the `Applet` class, all heavy-weight components, and many of the methods in the `Toolkit` and `GraphicsEnvironment` classes, which rely on the native display devices, are changed to throw `HeadlessException` if the platform does not support a display. In Oracle Database, user interfaces are supported only on client applications. Accordingly, Oracle JVM is a Headless Platform and throws `HeadlessException` if these methods are called.

Most AWT computation that does not involve accessing the underlying native display or input devices is allowed in Headless AWT. In fact, Headless AWT is quite powerful as it provides programmers access to fonts, imaging, printing, and color and ICC manipulation. For example, applications running in Oracle JVM can parse, manipulate,

and write out images as long as they do not try to physically display it on the server. The standard JVM implementation can be started in the Headless mode, by supplying the `-Djava.awt.headless=true` property, and run with the same Headless AWT restrictions as Oracle JVM does. Oracle JVM fully complies with the Java Compatibility Kit (JCK) with respect to Headless AWT.



See Also:

<http://www.oracle.com/technetwork/articles/javase/headless-136834.html>

Oracle JVM takes a similar approach for sound support. Applications in Oracle JVM are not allowed to access the underlying sound system for purposes of sound playback or recording. Instead, the system sound resources appear to be unavailable in a manner consistent with the sound API specification of the methods that are trying to access the resources. For example, methods in `javax.sound.midi.MidiSystem` that attempt to access the underlying system sound resources throw the `MidiUnavailableException` checked exception to signal that the system is unavailable. However, similar to the Headless AWT support, Oracle Database supports the APIs that allow sound file manipulation, free of the native sound devices. Oracle JVM also fully complies with the JCK, when it implements the sound API.

2.7 Shortened Class Names

Each Java source, class, and resource is stored in its own schema object in the server. The name of the schema object is derived from the fully qualified name, which includes relevant path or package information. Dots are replaced by slashes.

Schema object names, however, have a maximum of only 30 characters, and all characters must be legal and convertible to characters in the database character set. If any fully qualified name is longer than 30 characters or contains illegal or nonconvertible characters, then Oracle Database converts it to a short name, or alias, to use as the name of the schema object. Oracle Database keeps track of both the names and how to convert between them. If the fully qualified name is 30 characters or less and has no illegal or inconvertible characters, then it is used as the schema object name.

Because Java classes and methods can have names exceeding the maximum SQL identifier length, Oracle Database uses abbreviated names internally for SQL access. Oracle Database provides the `LONGNAME()` function within the `DBMS_JAVA` package for retrieving the original Java class name for any truncated name.

```
FUNCTION longname (shortname VARCHAR2) RETURN VARCHAR2
```

This function returns the fully qualified name of the Java schema object, which is specified using its alias. The following is an example of a statement used to display the fully qualified name of classes that are invalid:

```
SELECT dbms_java.longname (object_name) FROM user_objects WHERE object_type = 'JAVA CLASS' and status = 'INVALID';
```

You can also specify a full name to the database by using the `SHORTNAME()` function of the `DBMS_JAVA` package. The function takes a full name as input and returns the

corresponding short name. This function is useful for verifying whether the classes are loaded successfully, by querying the `USER_OBJECTS` view.

```
FUNCTION shortname (longname VARCHAR2) RETURN VARCHAR2
```

Related Topics

- [System Classes](#)

2.8 Class.forName() in Oracle Database

The JLS provides the following description of `Class.forName()`:

Given the fully qualified name of a class, this method attempts to locate, load, and link the class. If it succeeds, then a reference to the `Class` object for the class is returned. If it fails, then an instance of `ClassNotFoundException` is thrown.

Class lookup is always on behalf of a referencing class and is done through an instance of `ClassLoader`. The difference between the Java Development Kit (JDK) implementation and Oracle JVM implementation is the method in which the class is found:

- The JDK uses one instance of `ClassLoader` that searches the set of directory tree roots specified by the `CLASSPATH` environment variable.
- Oracle JVM defines several resolvers that specify how to locate classes. Every class has a resolver associated with it, and each class can, potentially, have a different resolver. When you run a method that calls `Class.forName()`, the resolver of the currently running class, which is `this`, is used to locate the class.

You can receive unexpected results if you try to locate a class with an incorrect resolver. For example, if a class `X` in schema `X` requests a class `Y` in schema `Y` to look up class `Z`, you will experience an error if you expected the resolver of class `X` to be used. Because class `Y` is performing the lookup, the resolver associated with class `Y` is used to locate class `Z`. In summary, if the class exists in another schema and you specified different resolvers for different classes, as would happen by default if they are in different schemas, you may not find the class.

You can solve this resolver problem as follows:

- Avoid any class name lookup by passing the `Class` object itself.
- Supply the `ClassLoader` instance in the `Class.forName()` method.
- Supply the class and the schema it resides in to the `classForNameAndSchema()` method.
- Supply the schema and class name to `Class.forName().lookupClass()`.
- Serialize your objects with the schema name and the class name.

Note:

Another unexpected behavior can occur if system classes invoke `Class.forName()`. The desired class is found only if it resides in `SYS` or in `PUBLIC`. If your class does not exist in either `SYS` or `PUBLIC`, then you can declare a `PUBLIC` synonym for the class.

This section covers the following topics:

- [Supply ClassLoader in Class.forName\(\)](#)
- [Supply Class and Schema Names to classForNameAndSchema\(\)](#)
- [Supply Class and Schema Names to lookupClass\(\)](#)
- [Supply Class and Schema Names when Serializing](#)
- [Class.forName Example](#)

Related Topics

- [Overview of Resolving Class Dependencies](#)

2.8.1 Supply ClassLoader in Class.forName()

Oracle Database uses resolvers for locating classes within schemas. Every class has a specified resolver associated with it, and each class can have a different resolver associated with it. As a result, the locating of classes is dependent on the definition of the associated resolver. The `ClassLoader` instance knows which resolver to use, based on the class that is specified. When you supply a `ClassLoader` instance to `Class.forName()`, your class is looked up in the schemas defined in the resolver of the class. The syntax of this variant of `Class.forName()` is as follows:

```
Class.forName (String name, boolean initialize, ClassLoader loader);
```

The following examples show how to supply the class loader of either the current class instance or the calling class instance.

Example 2-1 Retrieve Resolver from Current Class

You can retrieve the class loader of any instance by using the `Class.getClassLoader()` method. The following example retrieves the class loader of the class represented by instance `x`:

```
Class c1 = Class.forName (x.whatClass(), true, x.getClass().getClassLoader());
```

Example 2-2 Retrieve Resolver from Calling Class

You can retrieve the class of the instance that called the running method by using the `oracle.aurora.vm.OracleRuntime.getCallerClass()` method. After you retrieve the class, call the `Class.getClassLoader()` method on the returned class. The following example retrieves the class of the instance that called the `workForCaller()` method. Then, its class loader is retrieved and supplied to the `Class.forName()` method. As a result, the resolver used for looking up the class is the resolver of the calling class.

```
void workForCaller()
{
    ClassLoader cl=oracle.aurora.vm.OracleRuntime.getCallerClass().getClassLoader();
    ...
    Class c=Class.forName(name, true, cl);
    ...
}
```

2.8.2 Supply Class and Schema Names to classForNameAndSchema()

You can resolve the problem of where to find the class by supplying the resolver, which can identify the schemas to be searched. Alternatively, you can supply the schema in which the class is loaded. If you know in which schema the class is loaded, then you can use the `classForNameAndSchema()` method, which is in the `DbmsJava` class provided by Oracle Database. This method takes both the name of the class and the schema in which the class resides and locates the class within the designated schema.

Example 2-3 Providing Schema and Class Names

The following example shows how you can save the schema and class names using the `save()` method. Both names are retrieved, and the class is located using the `DbmsJava.classForNameAndSchema()` method.

```
import oracle.aurora.rdbms.ClassHandle;
import oracle.aurora.rdbms.Schema;
import oracle.aurora.rdbms.DbmsJava;

void save (Class c1)
{
    ClassHandle handle = ClassHandle.lookup(c1);
    Schema schema = handle.schema();
    writeName (schema.getName());
    writeName (c1.getName());
}

Class restore()
{
    String schemaName = readName();
    String className = readName();
    return DbmsJava.classForNameAndSchema (schemaName, className);
}
```

2.8.3 Supply Class and Schema Names to lookupClass()

You can supply a `String` value containing both the schema and class names to the `oracle.aurora.util.ClassForName.lookupClass()` method. When called, this method locates the class in the specified schema. The string must be in the following format:

```
"<schema>:<class>"
```

For example, to locate `com.package.myclass` in the `HR` schema, use the following:

```
oracle.aurora.util.ClassForName.lookupClass("HR:com.package.myclass");
```

Note:

Use uppercase characters for the schema name. In this case, the schema name is case-sensitive.

2.8.4 Supply Class and Schema Names when Serializing

When you deserialize a class, part of the operation is to lookup a class based on a name. To ensure that the lookup is successful, the serialized object must contain both the class and schema names.

Oracle Database provides the following classes for serializing and deserializing objects:

- `oracle.aurora.rdbms.DbmsObjectOutputStream`
This class extends `java.io.ObjectOutputStream` and adds schema names in the appropriate places.
- `oracle.aurora.rdbms.DbmsObjectInputStream`
This class extends `java.io.ObjectInputStream` and reads streams written by `DbmsObjectOutputStream`. You can use this class in any environment. If used within Oracle Database, then the schema names are read out and used when performing the class lookup. If used on a client, then the schema names are ignored.

2.8.5 Class.forName Example

The following example shows several methods for looking up a class:

```
import oracle.aurora.vm.OracleRuntime;
import oracle.aurora.rdbms.Schema;
import oracle.aurora.rdbms.DbmsJava;

public class ForName
{
    private Class from;

    /* Supply an explicit class to the constructor */
    public ForName(Class from)
    {
        this.from = from;
    }

    /* Use the class of the code containing the "new ForName()" */
    public ForName()
    {
        from = OracleRuntime.getCallerClass();
    }

    /* lookup relative to Class supplied to constructor */
    public Class lookupWithClassLoader(String name) throws ClassNotFoundException
    {
        /* A ClassLoader uses the resolver associated with the class*/
        return Class.forName(name, true, from.getClassLoader());
    }

    /* In case the schema containing the class is known */
    static Class lookupWithSchema(String name, String schema)
    {
        Schema s = Schema.lookup(schema);
        return DbmsJava.classForNameAndSchema(name, s);
    }
}
```

```
}
}
```

The preceding example uses the following methods for locating a class:

- To use the resolver of the class of an instance, call `lookupWithClassLoader()`. This method supplies a class loader to the `Class.forName()` method in the `from` variable. The class loader specified in the `from` variable defaults to this class.
- To use the resolver from a specific class, call `ForName()` with the designated class name, followed by `lookupWithClassLoader()`. The `ForName()` method sets the `from` variable to the specified class. The `lookupWithClassLoader()` method uses the class loader from the specified class.
- To use the resolver from the calling class, first call the `ForName()` method without any parameters. It sets the `from` variable to the calling class. Then, call the `lookupWithClassLoader()` method to locate the class using the resolver of the calling class.
- To lookup a class in a specified schema, call the `lookupWithSchema()` method. This provides the class and schema name to the `classForNameAndSchema()` method.

2.9 About Managing Your Operating System Resources

Operating system resources are a limited commodity on any computer. Because Java is targeted at providing a computing platform as well as a programming language, it contains platform-independent classes and frameworks for accessing platform-specific resources. The Java class methods access operating system resources through JVM. Java has potential problems with this model because programmers rely on the garbage collector to manage all resources, when all that the garbage collector manages is Java objects and not the operating system resources that the Java objects hold on to.

In addition, when you use shared servers, your operating system resources, which are contained within Java objects, can be invalidated if they are maintained across calls within a session.

The following sections discuss these potential problems:

- [Overview of Operating System Resources](#)
- [Garbage Collection and Operating System Resources](#)

Related Topics

- [Operating System Resources Affected Across Calls](#)

2.9.1 Overview of Operating System Resources

In general, your operating system resources contain the following:

Operating System Resources	Description
memory	Oracle Database manages memory internally, allocating memory as you create objects and freeing objects as you no longer need them. The language and class libraries do not support a direct means to allocate and free memory.

Operating System Resources	Description
files and sockets	Java contains classes that represent file or socket resources. Instances of these classes hold on to the file or socket constructs, such as file handles, of the operating system.
threads	Oracle JVM threads provide no additional scalability over what is provided by the database support of multiple concurrently executing sessions. However, Oracle JVM supports the full Java threading API.

Operating System Resource Access

By default, a Java user does not have direct access to most operating system resources. A system administrator can give permissions to a user to access these resources by modifying JVM security restrictions. JVM security enforced upon system resources conforms to Java 2 security.

Operating System Resource Lifetime

You can access operating system resources using the standard core Java classes and methods. Once you access a resource, the time that it remains active varies according to the type of resource. Memory is garbage collected. Files, threads, and sockets persist across calls when you use a dedicated mode server. In shared server mode, files, threads, and sockets terminate when the call ends.

Related Topics

- [Overview of Java 2 Security Features](#)
- [Operating System Resources Affected Across Calls](#)

2.9.2 Garbage Collection and Operating System Resources

Imagine that memory is divided into two realms: Java object memory and operating system constructs. The Java object memory realm contains all objects and variables. Operating system constructs include resources that the operating system allocates to the object when it asks. These resources include files, sockets, and so on.

Basic programming rules dictate that you close all memory, both Java objects and operating system constructs. Java programmers incorrectly assume that memory is freed by the garbage collector. The garbage collector was created to collect all unused Java object memory. However, it does not close operating system constructs. All operating system constructs must be closed by the program before the Java object is garbage collected.

For example, whenever an object opens a file, the operating system creates the file and gives the object a file handle. If the file is not closed, then the operating system holds the file handle construct open until the call ends or JVM exits. This may cause you to run out of these constructs earlier than necessary. There are a finite number of handles within each operating system. To guarantee that you do not run out of handles, close your resources before exiting the method. This includes closing the streams attached to your sockets before closing the socket.

For performance reasons, the garbage collector cannot examine each object to see if it contains a handle. As a result, the garbage collector collects Java objects and variables, but does not issue the appropriate operating system methods for freeing any handles.

[Example 2-4](#) shows how to close the operating system constructs.

If you do not close `inFile`, then eventually the `File` object will be garbage collected. Even after the `File` object is garbage collected, the operating system treats the file as if it were in use, because it was not closed.

 **Note:**

You may want to use Java finalizers to close resources. However, finalizers are not guaranteed to run in a timely manner. Instead, finalizers are put on a queue to run when the garbage collector has time. If you close your resources within your finalizer, then it might not be freed until JVM exits. The best approach is to close your resources within the method.

Example 2-4 Closing Your Operating System Resources

```
public static void addFile(String[] newFile)
{
    File inFile = new File(newFile);
    FileReader in = new FileReader(inFile);
    int i;

    while ((i = in.read()) != -1)
        out.write(i);

    /*closing the file, which frees up the operating system file handle*/
    in.close();
}
```

2.10 About Using the `Runtime.exec` Functionality in Oracle Database

Java Virtual Machine fully supports the family of Java Standard Edition `java.lang.Runtime.exec` methods. These methods spawn a new operating system (OS) process to run a user-supplied command. On the server, you must use these methods with caution. In Java Virtual Machine, OS command execution permissions are not granted to all database users by default and are issued only by privileged administrators. If you are a DBA, then you must know how to use the `Runtime.exec` functionality in Oracle Database and follow the recommendations. Also, you must be selective about issuing these permissions to database users.

Related Topics

- [Secure Use of `Runtime.exec` Functionality in Oracle Database](#)

2.11 Managing Your Applications Using JMX

This section contain the following topics:

- [Overview of JMX](#)
- [Enabling and Starting JMX in a Session](#)
- [Setting Oracle JVM JMX Defaults and Configurability](#)

- [Examples of SQL calls to `dbms_java.start_jmx_agent`](#)
- [Using JConsole to Monitor and Control Oracle JVM](#)
- [Important Security Notes](#)
- [Shared Server Limitations for JMX](#)

2.11.1 Overview of JMX

JMX (Java Management Extensions) is a Java technology that supplies tools for managing and monitoring applications, system objects, devices, service-oriented networks, and JVM (Java Virtual Machine). This API allows its classes to be dynamically constructed and changed. So, you can use this technology to monitor and manage resources as they are created, installed, and implemented. The JMX API also includes remote access, so a remote management program can interact with a running application for these purposes.

In JMX, a given resource is instrumented by one or more Java objects known as MBeans (Managed Beans). These MBeans are registered in a core managed object server, known as an MBean server, that acts as a management agent and can run on most devices enabled for the Java programming language. A JMX agent consists of an MBean server, in which MBeans are registered, and a set of services for handling MBeans.



See Also:

- <http://www.oracle.com/technetwork/java/javase/tech/javamanagement-140525.html>
- <http://docs.oracle.com/javase/7/docs/technotes/guides/security/jsse/JSSERefGuide.html>

2.11.2 Enabling and Starting JMX in a Session

To help in enabling and running JMX services in sessions running Java, the `JMXSERVER` role and the `dbms_java.start_jmx_agent` procedure are provided. The `JMXSERVER` role is granted specific Java permissions that enable you to start and run `MBeanServer` and JMX agent in a session. The procedure `dbms_java.start_jmx_agent` starts the agent in a specific session that generally remains active for the duration of the session. Perform the following to enable and start JMX:

1. Obtain `JMXSERVER` from `SYS` or `SYSTEM`:

```
SQL> grant jmxserver to HR;
```

where, `HR` is the user name.

2. Invoke the procedure `dbms_java.start_jmx_agent` to startup JMX in the session. The `dbms_java.start_jmx_agent` procedure can be invoked with the following arguments:

`port`: the port for the JMX listener. The value of this parameter sets the Java property `com.sun.management.jmxremote.port`.

`ssl`: sets the value for the Java property `com.sun.management.jmxremote.ssl`. Case for `true` and `false` values is ignored.

`auth`: the value for the property `com.sun.management.jmxremote.authenticate`, otherwise a semicolon-separated list of Java Authentication and Authorization Service (JAAS) credentials. The value is not case-sensitive.

Each of these arguments can be `null` or omitted, with `null` as the default value. when an argument is `null`, it does not alter the previously present value of the corresponding property in the session.

 **Note:**

The Java properties corresponding to the parameters of `dbms_java.start_jmx_agent` are from the set of Java properties specified in standard Java 5.0 JMX documentation. For the full list of Java JMX properties please refer to

<http://www.oracle.com/technetwork/java/javase/tech/javamanagement-140525.html>

The `dbms_java.start_jmx_agent` procedure starts an agent activating OJVM JMX server and a listener. The JMX server runs as one or more daemon threads in the current session and in general is available for the duration of the session. Once JMX Agent is started in a session, Java code running in the session can be monitored.

The `dbms_java.start_jmx_agent` procedure is a PL/SQL wrapper for the Java method `oracle.aurora.rdbms.JMXAgent.startOJVMAgent`, which by itself can also be called programmatically from Java stored procedures. The `startOJVMAgent` method starts the JMX Server and the JMX connectivity daemon threads, and then exits. On dedicated servers, these threads may remain active for the duration of the session, but go into an inert state for the time intervals between calls. When these intervals are short, then the same socket connections resume transparently. This enables clients such as JConsole to remain connected across multiple calls.

A different mode of JMX monitoring is possible with the `EXIT_CALL_WHEN_ALL_THREADS_TERMINATE` policy. By setting the call exit policy to `OracleRuntime.EXIT_CALL_WHEN_ALL_THREADS_TERMINATE`, you can configure the session to run JMX server continuously in a call that invokes the `startOJVMAgent` method till the Java call is exited programmatically. This mode is convenient when various Java tasks are fired up from a JMX client as operations of specific MBeans. This way, continuous JMX management and monitoring is driven by these operations. Please refer to the JVM JMX demo for such a bean, for example, `jmxserv.Load`.

Related Topics

- [Shared Server Limitations for JMX](#)

2.11.3 Setting Oracle JVM JMX Defaults and Configurability

When `dbms_java.start_jmx_agent` is activated, the property `com.sun.management.jmxremote` is set to `true`. Before invoking `start_jmx_agent`, a

JMXSERVER-privileged user can preset various management properties in the following ways:

- Using the PL/SQL function `dbms_java.set_property`
- Invoking method `java.lang.System.setProperty`

The JMXSERVER role user can also preset the properties in database resident Java resource specified by Java property `com.sun.management.config.file`. The default name for this resource, tried when `com.sun.management.config.file` is not set, is `lib.management.management.properties`. This resource mechanism is Oracle JVM extension of standard file-based JMX configuration management. This mechanism is superior for Oracle JVM as it provides more security and per-schema management. When the resource does not exist in schema, a file-read is attempted as a fall-back. The default file path, tried when `com.sun.management.config.file` is not set, is `$(java.home)/lib/management/management.properties`. In Oracle Database 12c this file contains the following presets:

```
com.sun.management.jmxremote.ssl.need.client.auth = true
com.sun.management.jmxremote.authenticate = false
```

The property `com.sun.management.jmxremote.ssl.need.client.auth` in conjunction with `com.sun.management.jmxremote.ssl`, sets JMX for two-way encrypted SSL authentication with client and server certificates. The default value of `com.sun.management.jmxremote.ssl` is `true`. This configuration is the default and is preferred over JAAS password authentication.

 **Note:**

For more information visit the following:

- <http://www.oracle.com/technetwork/java/javase/tech/javamanagement-140525.html>
- <http://docs.oracle.com/javase/7/docs/technotes/guides/security/jsse/JSSERefGuide.html>

 **Note:**

The default JMX Login Module providing file-based store for passwords is not supported in Oracle JVM for security reasons. So, if JAAS password authentication must be used instead of SSL client authentication, then pass transient JAAS credentials securely as the `auth` parameter to `dbms_java.start_jmx_agent` as illustrated in this section, or configure JMX to use a secure custom LDAP login module.

2.11.4 Examples of SQL calls to `dbms_java.start_jmx_agent`

Following are some examples of starting the JMX server:

- Starts the JMX server and the listener using the default settings as described in the preceding sections or the values set earlier in the same session:

```
call dbms_java.start_jmx_agent();
```

- Starts the JMX server and the listener using the default settings as described in the preceding sections or the values set earlier in the same session:

```
call dbms_java.start_jmx_agent(null, null, null);
```

- Starts the JMX server and the listener on port 9999 with the other JMX settings having the default values or the values set earlier in the same session:

```
call dbms_java.start_jmx_agent('9999');
```

- Starts the JMX server and the listener on port 9999 with the other JMX settings having the default values or the values set earlier in the same session:

```
call dbms_java.start_jmx_agent('9999', null, null);
```

- Starts the JMX server and the listener with the JMX settings having the default values or the values set earlier in the same session and with JAAS credentials `monitorRole/1z2x` and `controlRole/2p3o`:

```
call dbms_java.start_jmx_agent(null, null, 'monitorRole/1z2x;controlRole/2p3o');
```

These credentials are transient. The property `com.sun.management.jmxremote.authenticate` is set to `true`.

- Starts JMX listener on port 9999 with no SSL and no JAAS authentication. Used only for development or demonstration.

```
call dbms_java.start_jmx_agent('9999', 'false', 'false');
```

Related Topics

- [Important Security Notes](#)

2.11.5 Using JConsole to Monitor and Control Oracle JVM

This section describes how to use JConsole, a standard JMX client tool, for monitoring and controlling Oracle JVM. JConsole is a part of standard Java JDK.

This section discusses the following topics:

- [Using the `jconsole` Command](#)
- [About Using the JConsole interface](#)
- [The OracleRuntime MBean](#)
- [Memory Thresholds](#)

Note:

To monitor Java in the database with JConsole, you should have a server-side Java session running JMX Agent.

Related Topics

- [Enabling and Starting JMX in a Session](#)

2.11.5.1 Using the jconsole Command

Use the `jconsole` command syntax to start JConsole. The simplest format to start the JConsole tool is the following:

```
jconsole [hostName:portNum]
```

where:

- `hostname` is the name of the system running the application
- `portNum` is the port number of the JMX listener

In the following examples, we connect to a host with name `example.com` through default port 9999. This mode assumes no authentication and encryption. This mode is adequate only for demo or testing, and can be used to connect to Oracle JVM JMX sessions that are started with the following command:

```
call dbms_java.start_jmx_agent(portNum, false, false);
```

Remember that you can connect to and interact with Oracle JVM from JConsole, only when the daemon threads of the server are running and are not dormant. This means that there should be an active Java call in the session, which is running the JMX server on the specified port. During the time interval between subsequent Java calls, JMX server preserves its state and statistics, but is unable to communicate with JConsole.

Related Topics

- [Important Security Notes](#)

2.11.5.2 About Using the JConsole interface

The JConsole interface consists of the following tabs:

- **Summary tab**
It displays summary information on Oracle JVM and the values monitored by JMX.
- **Memory tab**
It displays information on memory usage.
- **Threads tab**
It displays information on thread usage.
- **Classes tab**
It displays information on class loading.
- **MBeans tab**
It displays information on MBeans.
- **VM tab**
It displays information on Oracle JVM.

 **Note:**

In Oracle Database 12c Release 1 (12.1), the data collected and passed to JConsole is limited to the Oracle JVM session that runs the JMX agent. This data does not include the attributes of other sessions that may be running in Oracle JVM. One exception is the `OracleRuntime` MBean that provides information about many `WholeJVM_Attributes` and operations of Oracle JVM.

Related Topics

- [The OracleRuntime MBean](#)

2.11.5.3 About Viewing Oracle JVM Summary Information

You can use the Summary tab of the JConsole interface to view Oracle JVM Summary Information. This tab displays key monitoring information on thread usage, memory consumption, class loading, and other VM and operating system specifics.

If JConsole successfully connects to an Oracle JVM session running a JMX Agent, then the Overview Tab looks the following image:

Figure 2-6 The Overview Tab of the JConsole Interface

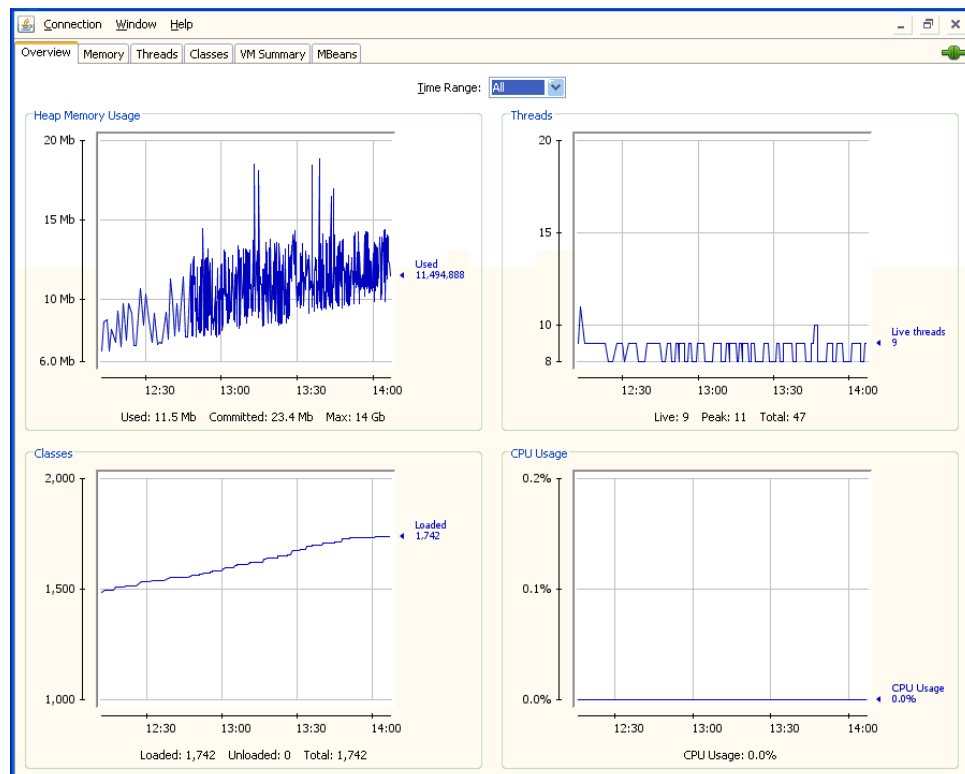

Table 2-10 provides description of the fields present in the Overview tab.

Table 2-10 Description of the Overview Tab Fields in JConsole Interface

Field	Description
Uptime	The duration for which the Oracle JVM session has been running.
Process CPU time	This information is not gathered for Oracle JVM sessions in Oracle Database 12c Release 1 (12.1).
Live threads	The current number of live daemon and non-daemon threads.
Peak	Highest number of live threads since Oracle JVM started.
Daemon threads	Current number of live daemon threads.
Total started	Total number of threads started since Oracle JVM started. It includes daemon, non-daemon, and terminated threads.
Current heap size	Number of kilobytes currently occupied by the heap.
Committed memory	Total amount of memory allocated for use by the heap.
Maximum heap size	Maximum number of kilobytes occupied by the heap.
Objects pending for finalization	Number of objects pending for finalization.
Garbage collector information	Information about the garbage collector, which includes name, number of collections performed, and total time spent performing garbage collection.
Current classes loaded	Number of classes currently loaded into memory for execution.
Total classes loaded	Total number of classes loaded into session memory since the session started.
Total classes unloaded	Number of classes unloaded from memory. Typically this is zero for Oracle Database 12c Release 1 (12.1).
Total physical memory	This information is not gathered for Oracle JVM sessions in Oracle Database 12c Release 1 (12.1). So, the value displayed is zero.
Free physical memory	This information is not gathered for Oracle JVM sessions in Oracle Database 12c Release 1 (12.1). So, the value displayed is zero.
Committed virtual memory	This information is not gathered for Oracle JVM sessions in Oracle Database 12c Release 1 (12.1). So, the value displayed is zero.

2.11.5.4 About Monitoring Memory Consumption

You can use the Memory tab of the JConsole interface to monitor memory consumption. This tab provides information on memory consumption and memory pools. Figure 2–7 shows the Memory tab.

Figure 2-7 The Memory Tab of the JConsole Interface

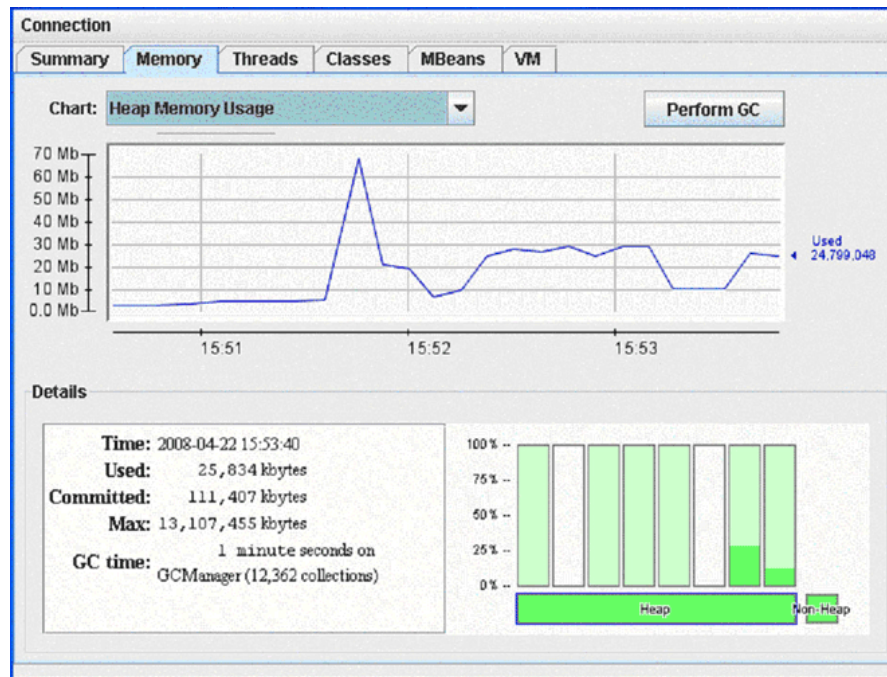

The chart on the Memory tab shows Oracle JVM memory usages versus time, for the whole memory space and also for specific memory pools. The memory pools available for Oracle JVM reflect the internal organization of Oracle JVM and correspond to object memories of Oracle JVM Memory Manager. The available memory pools in this release of Oracle Database are:

- **New Generation Space**
This is the memory pool from which memory is initially allocated for most objects. This pool is also referred to as the Eden Space.
- **Old Generation Space**
This memory pool contains objects that have survived the garbage collection process in Eden Space. This pool is also referred to as the Survival Space.
- **Malloc/Free Space**
This memory pool contains objects for which memory is allocated and freed in malloc/free fashion.
- **End of Migration Space**
This memory pool contains objects surviving end-of-session migration.
- **Dedicated Session Space**
This memory pool is used to allocate memory to session objects in Oracle Dedicated Sessions mode.
- **Paged Session Space**
This memory pool is used to allocate memory to session objects that are big and paged.
- **Run space**

This memory pool is used to allocate memory to temporary and auxiliary objects.

- Stack space

This memory pool is used to allocate memory to temporary objects for which memory is allocated and freed in stack-like fashion.

The Details area in the Memory tab displays current memory matrixes that include the following:

- Used

This matrix indicates the amount of memory currently used by the process running the session.

- Committed

This matrix indicates the amount of memory guaranteed to be available for use by Oracle JVM, as if the memory has already been allocated. The amount of Committed memory may change over time. But Committed memory will always be greater than or equal to Used memory.

- Max

This matrix indicates the maximum amount of memory that can be used for memory management. It usually corresponds to the initial configuration of Oracle JVM.

The bar chart at the lower right corner of the Memory tab shows memory consumed by the individual memory pools. The bar turns red when the memory used exceeds the memory usage threshold. You can set the memory usage threshold through an attribute of the `MemoryMXBean`.

Related Topics

- [Memory Thresholds](#)

2.11.5.5 About Monitoring Thread Use

You can use the Threads tab of the JConsole interface to monitor thread usage.

Figure 2-8 The Threads Tab of the JConsole Interface

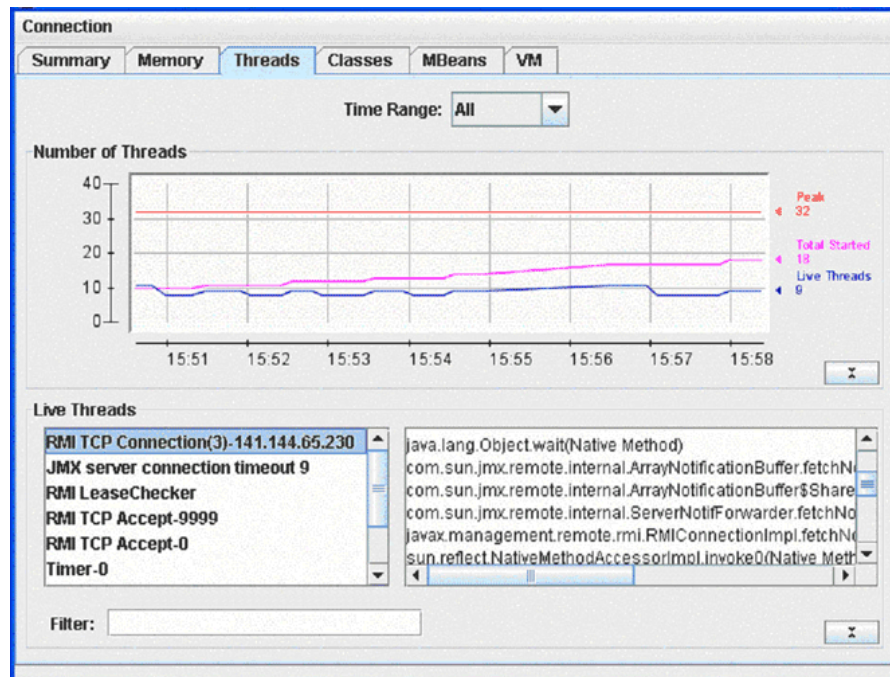

The chart on the Threads tab displays the number of live threads versus time, with a particular color representing a particular type of thread:

- Magenta signifies total number of threads
- Red signifies peak number of threads
- Blue signifies number of live threads

The list of threads on this tab displays the active threads. Select a thread in the list to display information about that thread on the right pane. This information includes name, state, and stack trace of the thread.

The Filter field helps to narrow the threads.

2.11.5.6 About Monitoring Class Loading

You can use the Classes tab of the JConsole interface to monitor class loading. The chart on this tab plots the number of classes loaded versus time.

Figure 2-9 The Classes tab of the JConsole interface

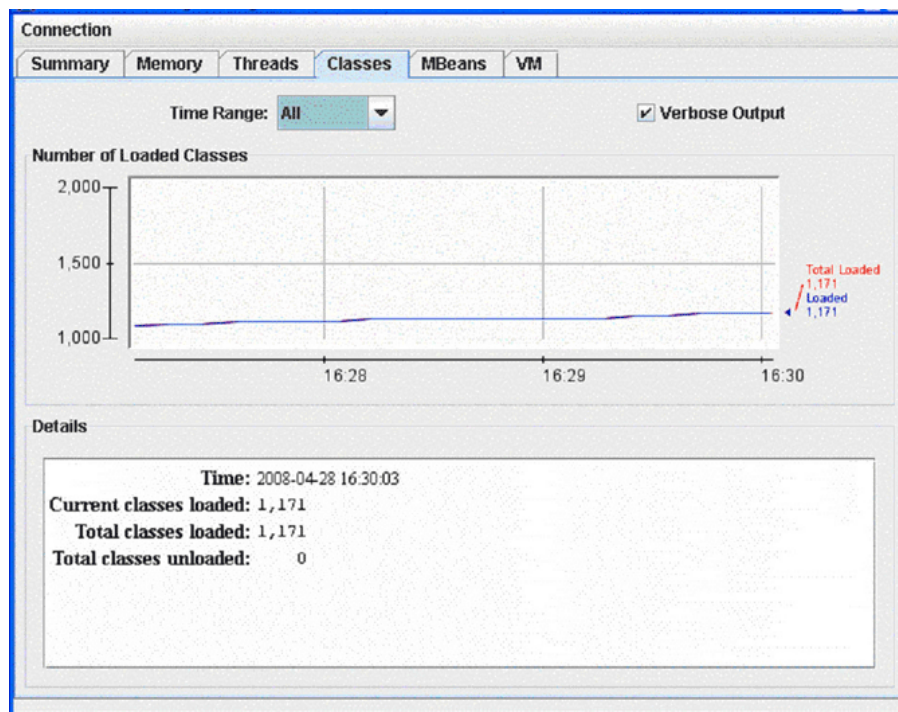

2.11.5.7 About Monitoring and Managing MBeans

You can use the MBeans tab to monitor and manage MBeans. This tab displays information on all the MBeans registered with the platform MBean server.

The tree on the left pane of the MBean tab is called the MBean tree and it shows all the MBeans, organized according to their object Names. When you select an MBean in the MBean tree, then its attributes, operations, notifications, and other information are displayed on the right pane. For example, in [Figure 2-10](#), we have selected the `old Generation MemoryPool` MBean in the MBean tree on the left and the attributes of the `old Generation MemoryPool` MBean are displayed on the right.

Figure 2-10 Displaying the Attributes of an MBean

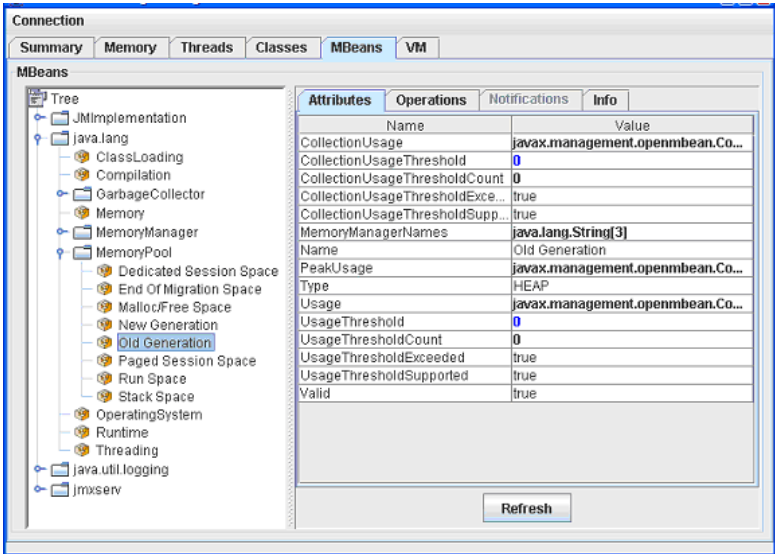

You can set the values of an attribute, if it is writeable. The writeable values are displayed in blue color. For example, in Figure 2-10, the attributes CollectionUaageThreshold and UsageThreshold are writable.

You can also display a chart of the values of an attribute versus time, by double-clicking on the attribute value. For example, if you click on the value of the CollectionTime property of the GCManager MBean, then you will see a chart similar to Figure 2-11:

Figure 2-11 Displaying a Chart of the Values of an Attribute

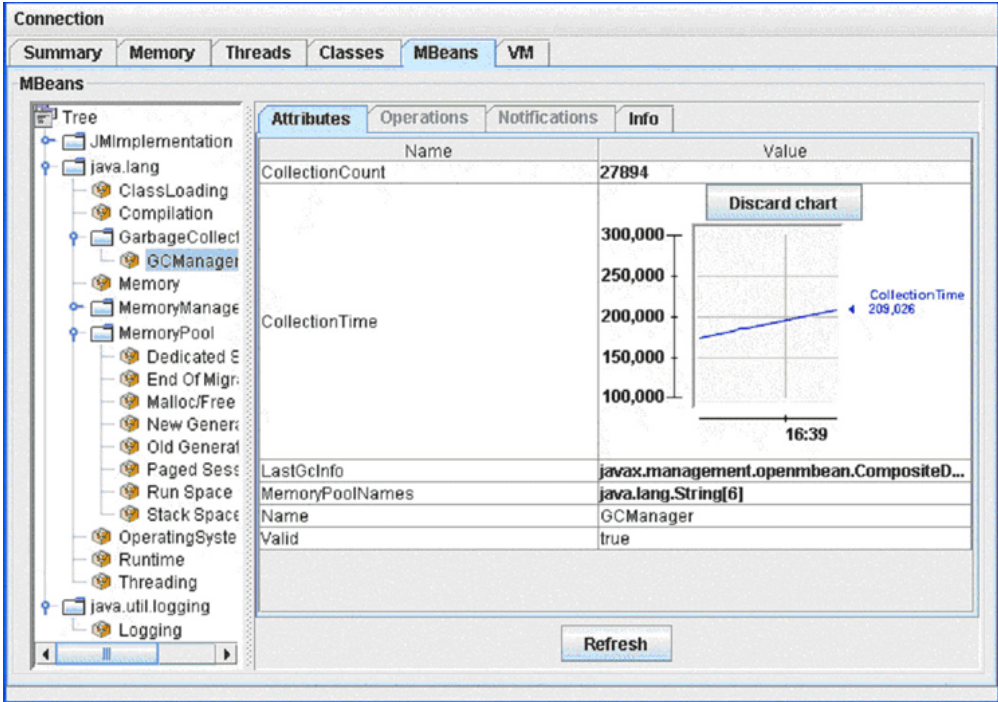

You can display the details of a complex attribute by clicking on the attribute. For example, you can display the details of `Usage` and `PeakUsage` attributes of the Memory Pools as shown in [Figure 2-12](#):

Figure 2-12 Displaying Details of a Complex Attribute in the MBeans Tab

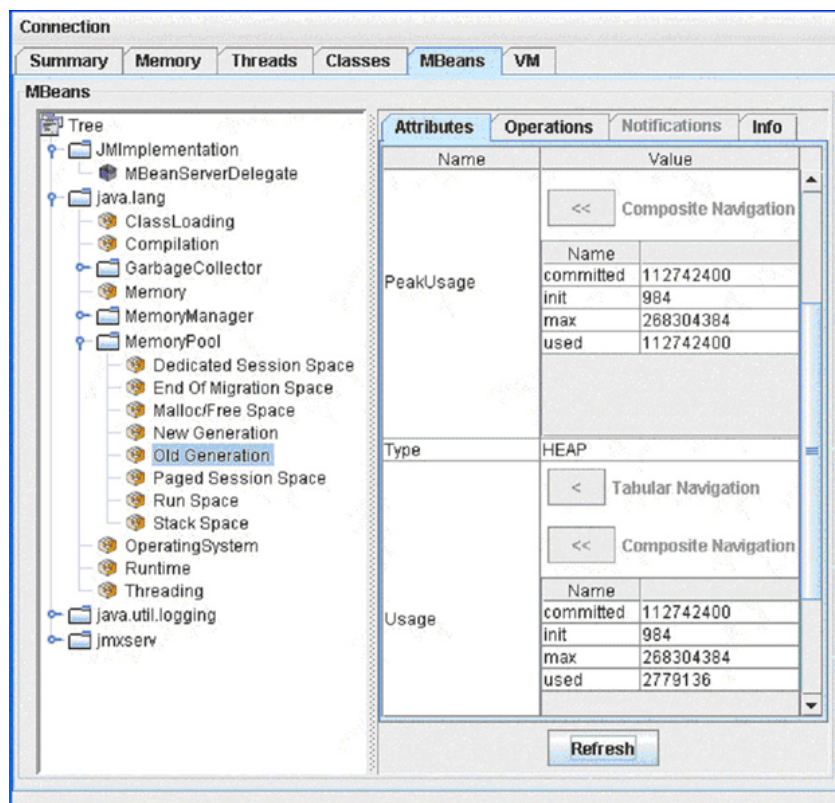

The Operations tab of an MBean provides manageability interface. For example, garbage collection can be invoked on a Memory Pool or Memory Manager by clicking **Perform Garbage Collection**. The JMX demo of Oracle JVM, namely, `javavm/demo/jmx/`, provides several additional custom MBeans that are loaded into Oracle JVM. Here is an example shows the result of the `getProp` operation of the `DBProps` Mbean:

Figure 2-13 Operations Tab of the MBeans Tab of the JConsole Interface

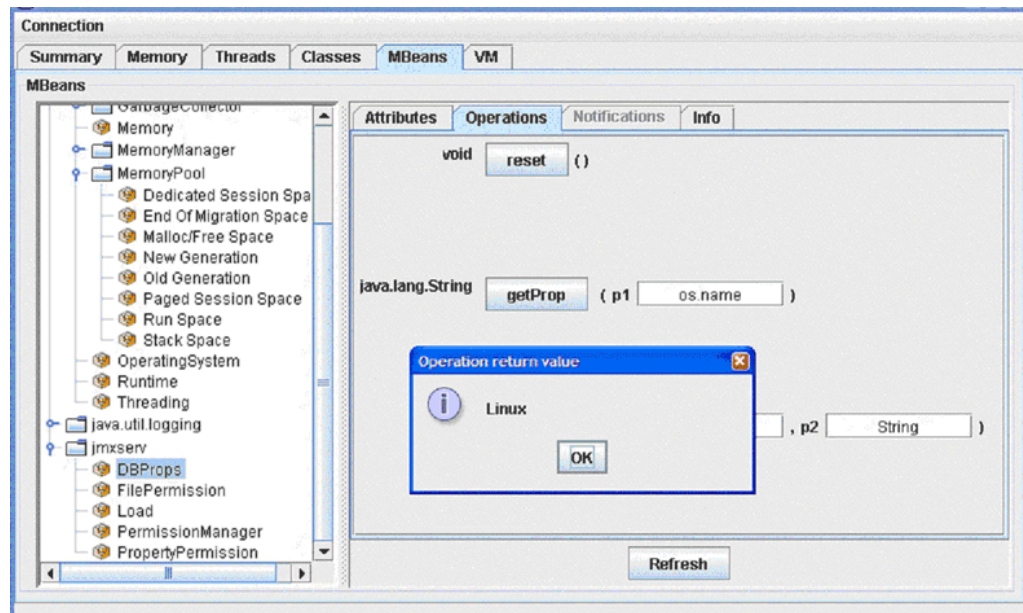

2.11.5.8 About Viewing VM Information

You can use the VM tab of the JConsole interface to view VM information.

Figure 2-14 The VM Tab of the JConsole Interface

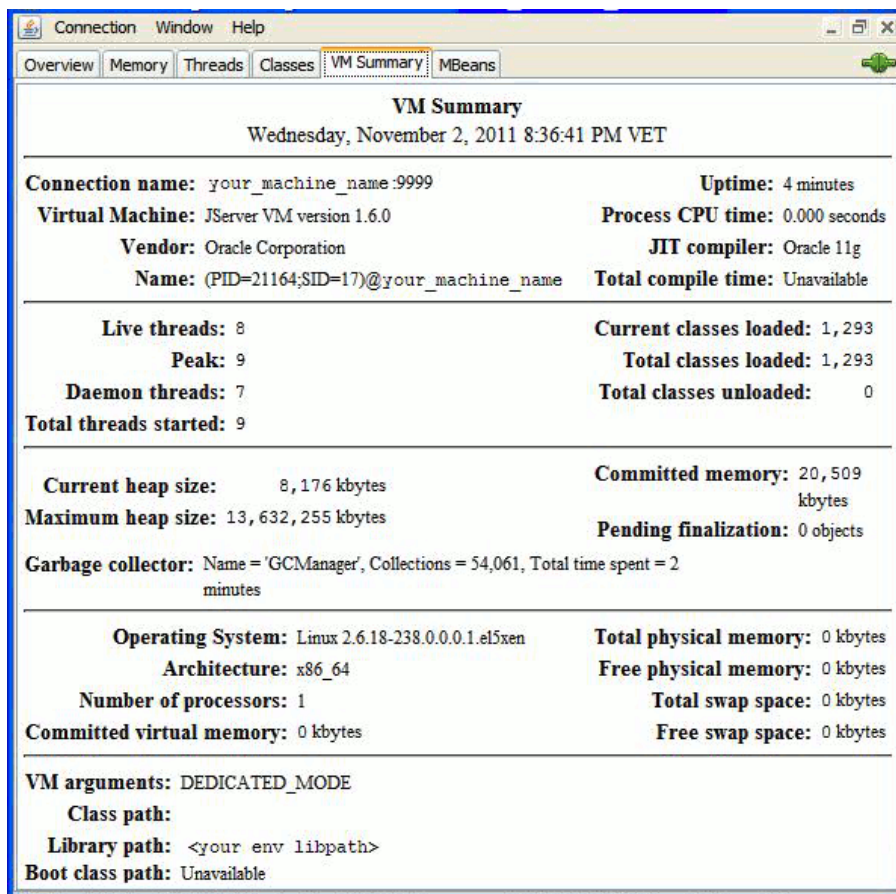

2.11.5.9 The OracleRuntime MBean

Starting from Oracle Database 11g Release 2 (11.2), a new MBean, `OracleRuntime` is added to the list of Oracle JVM platform MBeans, when the `dbms_java.start_jmx_agent` procedure is called. This MBean is specific to Oracle JVM.

The Attributes Tab of the `OracleRuntime` MBean exposes most of the parameters manipulated by the `oracle.aurora.vm.OracleRuntime` class. Figure 2-15 shows the Attributes tab of the `OracleRuntime` MBean.

Figure 2-15 Attributes Tab of the OracleRuntime MBean

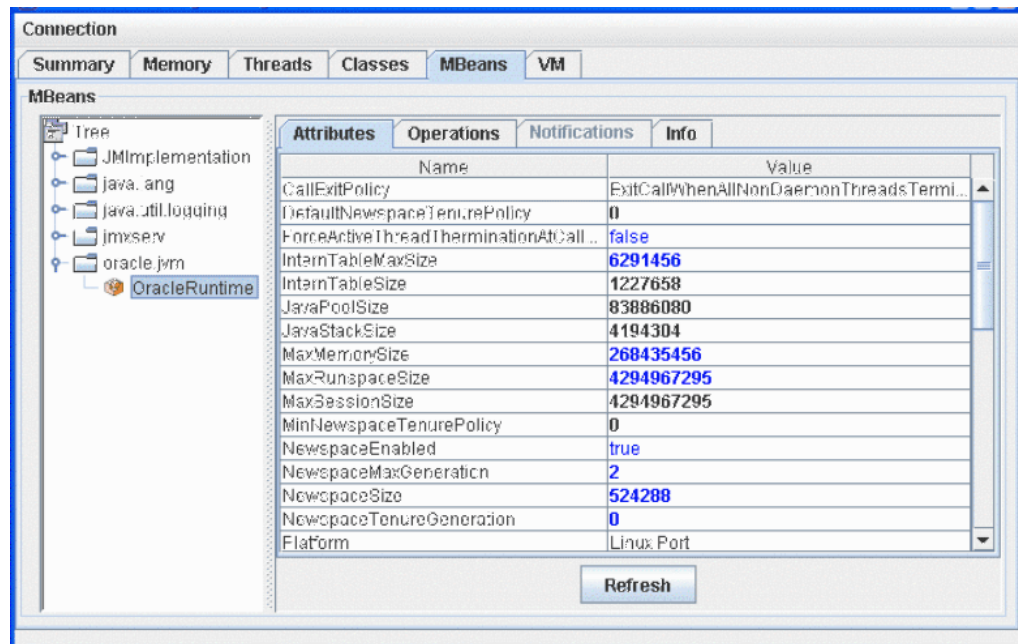

The parameters displayed in black color are read-only and cannot be modified. For example, `JavaPoolSize`, `Platform`, and so on. Values in blue color are read/write, which means you can modify them. Most of the attributes of the `OracleRuntime` MBean are local to the current session.

The `WholeJVM_` attributes of the `OracleRuntime` MBean are global. These attributes reflect the totals of Oracle JVM memory usage statistics across all Java-enabled sessions in the Database instance, as gathered from the `v$session` and `v$sesstat` performance views. [Figure 2-16](#) displays the `WholeJVM_` attributes of the `OracleRuntime` MBean.

Figure 2-16 OracleRuntime MBean

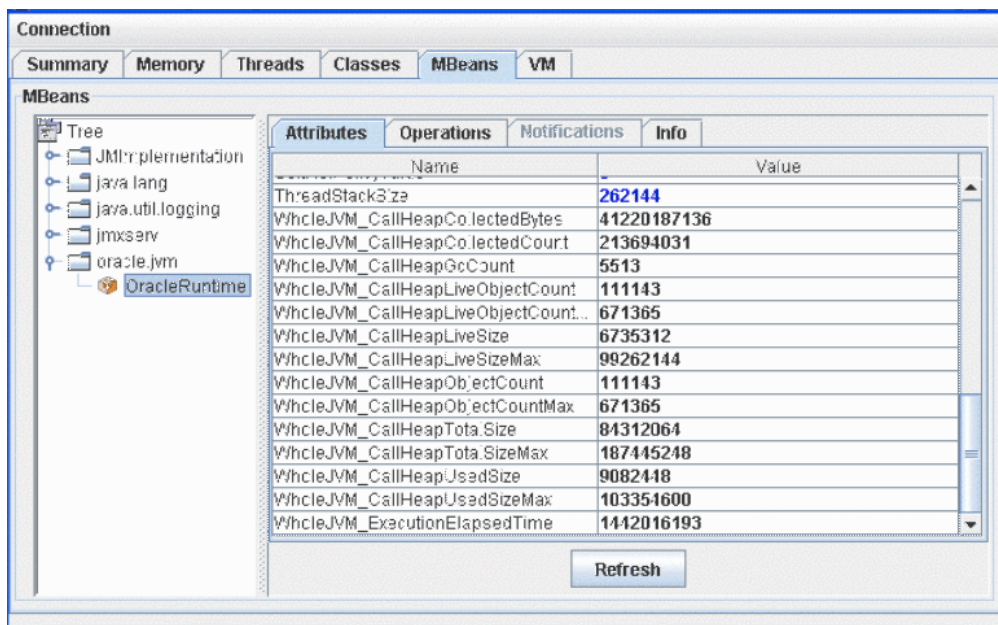

The Operations Tab of the OracleRuntime MBean exposes many of the operations of the oracle.aurora.vm.OracleRuntime class.

In addition, individual memory consumption statistics of a specific Java-active Database session can be monitored using the sessionsRunningJava and sessionDetailsBySID operations as shown in Figure 2-17 and Figure 2-18.

Figure 2-17 Operation sessionsRunningJava

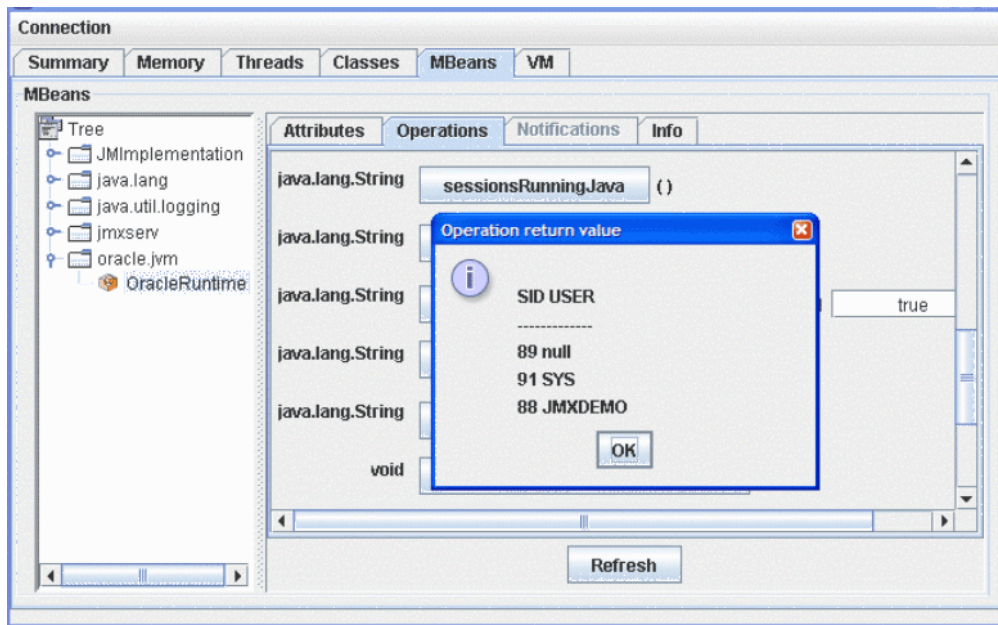
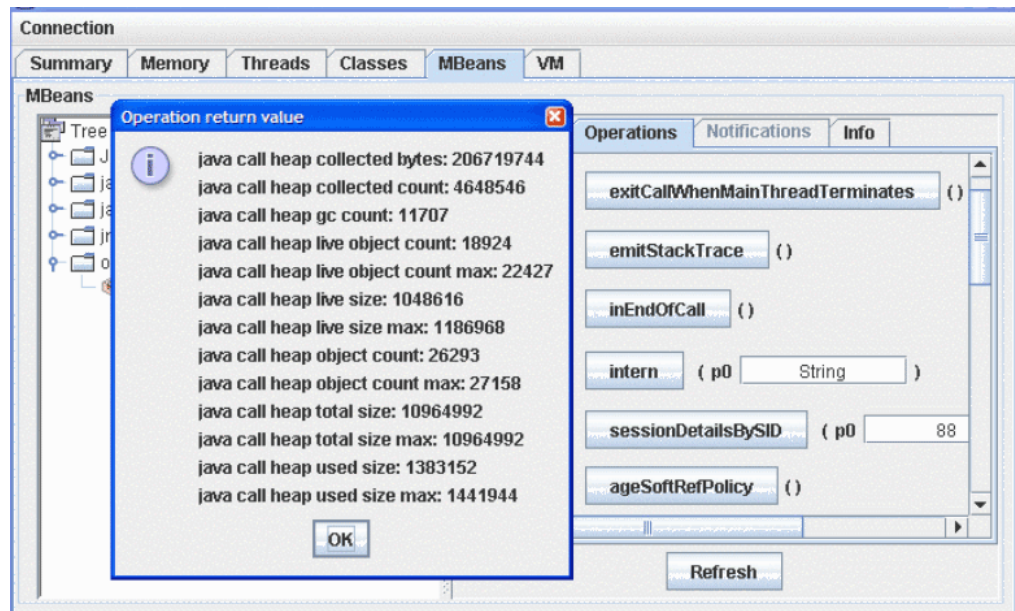

Figure 2-18 Operation sessionDetailsBySID



2.11.5.10 Memory Thresholds

The usage threshold is a manageable attribute of the memory pools. Collection usage threshold is a manageable attribute of some of the garbage-collected memory pools. You can set each of these to a positive value to enable corresponding threshold checking for a pool. Setting a threshold to zero disables the threshold checking for the memory pool. By default, threshold checking for all Oracle JVM pools is disabled.

The usage threshold and the collection usage threshold are set in the MBeans tab. For example, if you select the Old Generation memory pool from the tree on the left pane, and set the usage threshold of this memory pool to 20 megabytes and the collection threshold to 1 megabyte, then after a while, the threshold counts will show the number of threshold crossing events as shown in [Figure 2-19](#):

Figure 2-19 Setting the Usage Threshold and Collection Usage Threshold in the MBeans Tab

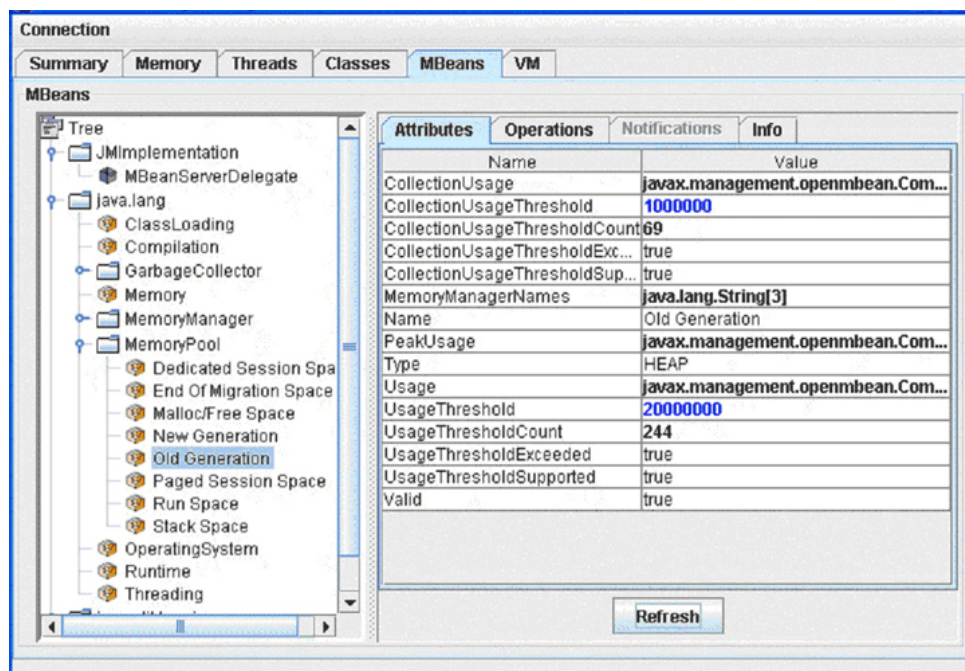

When the memory usage of the Old Generation memory pool exceeds 20 megabytes, then part of the bar representing the Old Generation memory pool in the JConsole interface turns red. The red portion indicates the portion of used memory that exceeds the usage threshold. The bar representing the heap memory also turns red as shown in [Figure 2-20](#):

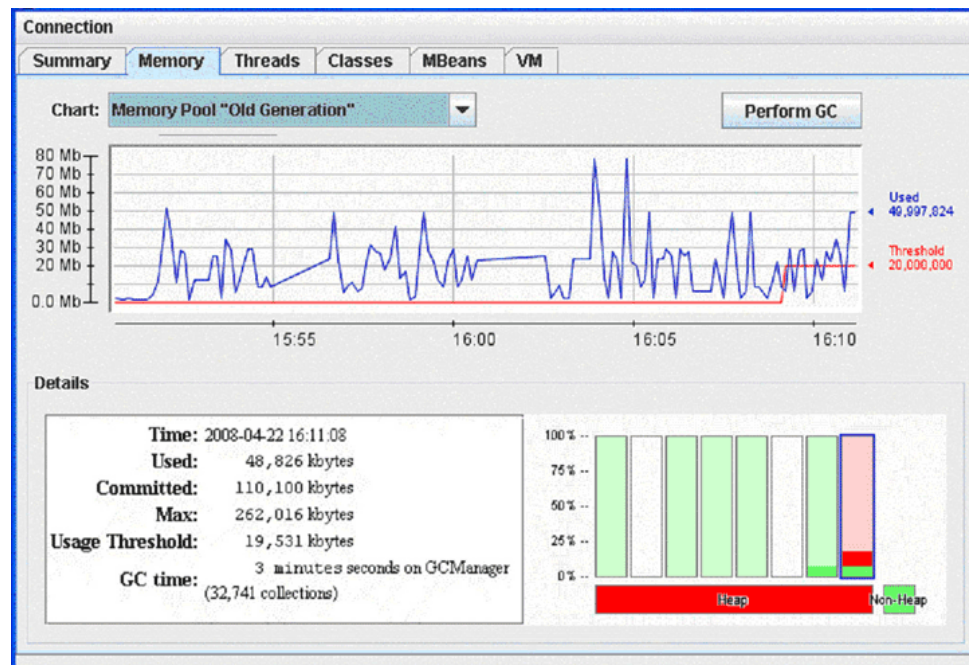
Figure 2-20 Memory Tab of the JConsole Interface When Used Memory Exceeds the Usage Threshold

2.11.6 Important Security Notes

By starting the remote listener with disabled SSL and authentication you violate the general security guidelines and hence make server vulnerable to attacks. Therefore, it is always advisable not to use such mode in production environment. This mode is supported for compatibility with JDK and for development; any production use of JMX in Oracle JVM must use secure JMX connections.

When supplying security-related property values to `dbms_java.set_property`, `System.setProperty`, or `dbms_java.start_jmx_agent`, use a non-echo listener or invoke these through an encrypted JDBC connection from a secure application layer, such as Oracle Application Server. Do not store passwords in clear-text files. Use Oracle Wallet to create and manage certificates. Use client certificates for SSL authentication for better security.

See Also:

Oracle Database Security Guide

2.11.7 Shared Server Limitations for JMX

On dedicated mode servers, JMX connectivity is supported for the duration of a session. Shared server JMX connectivity is typically limited to a single call. The main factor causing this limitation is the fact that JMX connectivity intrinsically depends on operating system resources such as threads and sockets. These resources do not

survive shared server call boundaries. As the result, JMX connectivity is fully supported only for the duration of a single call.

 **Note:**

This restriction only affects agent connectivity and not the state of the MBeanServer and Mbeans registered in it. The state of the MBeanServer and Mbeans, and in particular, the statistics, are persevered across shared server call boundaries.

If using dedicated server mode is not feasible, you can still establish JMX connectivity and monitor shared servers by following these guidelines:

- Plan for all JMX management and monitoring activities to happen within a single Java call.
- Do not set the `com.sun.management.jmxremote.port` property by calling the `DBMS_JAVA.set_property` function and do not use the `DBMS_JAVA.start_jmx_agent` method because these calls activate JMX and introduce a shared server call boundary. Instead, start the JMX agent by calling the `oracle.aurora.rdbms.JMXAgent.startOJVMAgent` method directly from the Java code to be monitored. The value for the `com.sun.management.jmxremote.port` property should be passed to the `startOJVMAgent` method. JMX-related properties other than the `com.sun.management.jmxremote.port` property do not wake up a JMX Agent and can be set using any means.

Related Topics

- [Shared Servers Considerations](#)

2.12 Overview of Threading in Oracle Database

Oracle JVM is based on the database session model, which is a single-client, nonpreemptive threading model. Although Java in Oracle Database allows running threaded programs, it is single-threaded at the execution level. In this model, JVM runs all Java threads associated with a database session on a single operating system thread. Once dispatched, a thread continues execution until it explicitly yields by calling `Thread.yield()`, blocks by calling `Socket.read()`, or is preempted by the execution engine. Once a thread yields, blocks or is preempted, JVM dispatches another thread.

 **Note:**

Starting with 11g release 1 (11.1), Oracle JVM supports thread preemption. Thread preemption is not mandated by the Java specification, but is needed to support the new `java.util.concurrent` API, present in JDK1.5, properly.

Oracle JVM has added the following features for better performance and thread management:

- System calls are at a minimum. Oracle JVM has exchanged some of the standard system calls with nonsystem solutions. For example, entering a monitor-synchronized block or method does not require a system call.
- Deadlocks are detected.
 - Oracle JVM monitors for deadlocks between threads. If a deadlock occurs, then Oracle JVM terminates one of the threads and throws the `oracle.aurora.vm.DeadlockError` exception.
 - Single-threaded applications cannot suspend. If the application has only a single thread and you try to suspend it, then the `oracle.aurora.vm.LimboError` exception is thrown.

2.12.1 Thread Life Cycle

In a single-threaded application, a call ends when one of the following events occurs:

- The thread returns to its caller.
- An exception is thrown and is not caught in Java code.
- The `System.exit()`, `OracleRuntime.exitSession()`, or `oracle.aurora.vm.OracleRuntime.exitCall()` method is called.
- The `DBMS_JAVA.endsession()` or `DBMS_JAVA.endsession_and_related_state()` method is called.

If the initial thread creates and starts other Java threads, then the call ends in one of the following ways:

- The main thread returns to its caller or an exception is thrown and not caught in this thread and in either case all other non-daemon threads are processed. Non-daemon threads complete either by returning from their initial method or because an exception is thrown and not caught in the thread.
- Any thread calls the `System.exit()`, `OracleRuntime.exitSession()`, or `oracle.aurora.vm.OracleRuntime.exitCall()` method.
- A call to `DBMS_JAVA.endsession()` or `DBMS_JAVA.endsession_and_related_state()` method.

Prior to 11g release 1 (11.1), when a call ended because of a call to `System.exit()` or `oracle.aurora.vm.OracleRuntime.exitCall()`, Oracle JVM ended the call abruptly and terminated all threads, in both the dedicated and shared server modes. Since 11g release 1 (11.1), this is addressed by the addition of the following PL/SQL functions to the `DBMS_JAVA` package:

- `FUNCTION endsession RETURN VARCHAR2;`
- `FUNCTION endsession_and_related_state RETURN VARCHAR2;`

During a call, a Java program can recursively cause more Java code to be run. For example, your program can issue a SQL query using JDBC or SQLJ that, in turn, calls a trigger written in Java. All the preceding remarks regarding call lifetime apply to the top-most call to Java code, not to the recursive call. For example, a call to `System.exit()` from within a recursive call exits the entire top-most call to Java, not just the recursive call.

Related Topics

- [Operating System Resources Affected Across Calls](#)

- [Two-Tier Duration for Java Session State](#)

2.12.2 System.exit(), OracleRuntime.exitSession(), and OracleRuntime.exitCall()

The `System.exit()` method terminates JVM, preserving no Java state. It does not cause the database session to terminate or the client to disconnect. However, the database session may, and often does, terminate itself immediately afterward. `OracleRuntime.exitSession()` also terminates JVM, preserving no Java state. However, it also terminates the database session and disconnects the client.

The behavior of `OracleRuntime.exitCall()` varies depending on `OracleRuntime.threadTerminationPolicy()`. This method returns a boolean value. If this value is `true`, then any active thread should be terminated, rather than left quiescent, at the end of a database call.

- In a shared server process, `threadTerminationPolicy()` is always `true`.
- In a shadow (dedicated) process, the default value is `false`. You can change the value by calling `OracleRuntime.setThreadTerminationPolicy()`.
 - If you set the value to `false`, that is the default value, all threads are left quiescent but receive a `ThreadDeath` exception for graceful termination.
 - If the value is `true`, all threads are terminated abruptly.

In addition, there is another method, `OracleRuntime.callExitPolicy()`. This method determines when a call is exited if none of the `OracleRuntime.exitSession()`, `OracleRuntime.exitCall()`, or `System.exit()` methods were ever called. The call exit policy can be set to one of the following, using `OracleRuntime.setCallExitPolicy()`:

- `OracleRuntime.EXIT_CALL_WHEN_MAIN_THREAD_TERMINATES`

If set to this value, then as soon as the main thread returns or an uncaught exception occurs on the main thread, all remaining threads, both daemon and non-daemon are:

 - Killed, if `threadTerminationPolicy()` is `true`, always in shared server mode.
 - Left quiescent, if `threadTerminationPolicy()` is `false`.
- `OracleRuntime.EXIT_CALL_WHEN_ALL_NON_DAEMON_THREADS_TERMINATE`

This is the default value. If this value is set, then the call ends when only daemon threads are left running. At this point:

 - If the `threadTerminationPolicy()` is `true`, always in shared server mode, then the daemon threads are killed.
 - If the `threadTerminationPolicy()` is `false`, then the daemon threads are left quiescent until the next call. This is the default setting for shadow (dedicated) server mode.
- `OracleRuntime.EXIT_CALL_WHEN_ALL_THREADS_TERMINATE`

If set to this value, then the call ends only when all threads have either returned or ended due to an uncaught exception. At this point, the call ends regardless of the value of `threadTerminationPolicy()`.

 **Note:**

In Oracle database 9.x and earlier database releases, JVM behaves as if the `callExitPolicy()` were `OracleRuntime.EXIT_CALL_WHEN_ALL_NON_DAEMON_THREADS_TERMINATE` and the `threadTerminationPolicy()` were `true` for both shared and dedicated server processes. This means kill the daemon threads at this point. Also, if `exitCall()` were executed, then all threads are killed before the call is ended, in both shared and dedicated server processes.

2.13 Shared Servers Considerations

 **Note:**

Oracle recommends dedicated servers for performance reasons. Additionally, dedicated servers support a class of applications that rely on threads and sockets that stay open across calls. For example, the JMX agent connectivity functionality.

For sessions that use shared servers, certain limitations exist across calls. The reason is that a session that uses a shared server is not guaranteed to connect to the same process on a subsequent database call, and hence the session-specific memory and objects that need to live across calls are saved in the SGA. This means that process-specific resources, such as threads, open files, and sockets, must be cleaned up at the end of each call, and therefore, will not be available for the next call.

This section covers the following topics:

- [End-of-Call Migration](#)
- [Oracle-Specific Support for End-of-Call Optimization](#)
- [The `EndOfCallRegistry.registerCallback\(\)` Method](#)
- [The `EndOfCallRegistry.runCallbacks\(\)` Method](#)
- [The Callback Interface](#)
- [The `Callback.act\(\)` method](#)
- [Operating System Resources Affected Across Calls](#)

Related Topics

- [Managing Your Applications Using JMX](#)

2.13.1 End-of-Call Migration

In the shared server mode, Oracle Database preserves the state of your Java program between calls by migrating all objects that are reachable from `static` variables to session space at the end of the call. Session space exists within the session of the client to store `static` variables and objects that exist between calls. Oracle JVM automatically performs this migration operation at the end of every call.

This migration operation is a memory and performance consideration. Hence, you should be aware of what you designate to exist between calls and keep the `static` variables and objects to a minimum. If you store objects in `static` variables needlessly, then you impose an unnecessary burden on the memory manager to perform the migration and consume per-session resources. By limiting your `static` variables to only what is necessary, you help the memory manager and improve the performance of your server.

To maximize the number of users who can run your Java program at the same time, it is important to minimize the footprint of a session. In particular, to achieve maximum scalability, an inactive session should take up as little memory space as possible. A simple technique to minimize footprint is to release large data structures at the end of every call. You can lazily re-create many data structures when you need them again in another call. For this reason, Oracle JVM has a mechanism for calling a specified Java method when a session is about to become inactive, such as at the end of a call.

This mechanism is the `EndOfCallRegistry` notification. It enables you to clear `static` variables at the end of the call and reinitialize the variables using a lazy initialization technique when the next call comes in. You should run this only if you are concerned about the amount of storage you require the memory manager to store in between calls. It becomes a concern only for complex stateful server applications that you implement in Java.

The decision of whether to null-out data structures at the end of the call and then re-create them for each new call is a typical time and space trade-off. There is some extra time spent in re-creating the structure, but you can save significant space by not holding on to the structure between calls. In addition, there is a time consideration, because objects, especially large objects, are more expensive to access after they have been migrated to session space. The penalty results from the differences in representation of session, as opposed to objects based on call-space.

Examples of data structures that are candidates for this type of optimization include:

- Buffers or caches.
- Static fields, such as arrays, which once initialized can remain unchanged during the course of the program.
- Any dynamically built data structure that can have a space-efficient representation between calls and a more speed-efficient representation for the duration of a call. This can be tricky and may complicate your code, making it hard to maintain. Therefore, you should consider doing this only after demonstrating that the space saved is worth the effort.

2.13.2 Oracle-Specific Support for End-of-Call Optimization

You can register the `static` variables that you want cleared at the end of the call when the buffer, field, or data structure is created. Within the `oracle.aurora.memoryManager.EndOfCallRegistry` class, the `registerCallback()` method takes an object that implements a `Callback` object. The `registerCallback()` method stores this object until the end of the call. At the end of the call, Oracle JVM calls the `act()` method within all registered `Callback` objects. The `act()` method within the `Callback` object is implemented to clear the user-defined buffer, field, or data structure. Once cleared, the `Callback` object is removed from the registry.

 **Note:**

If the end of the call is also the end of the session, then callbacks are not started, because the session space will be cleared anyway.

A weak table holds the registry of end-of-call callbacks. If either the `Callback` object or value are not reachable from the Java program, then both the object and the value will be dropped from the table. The use of a weak table to hold callbacks also means that registering a callback will not prevent the garbage collector from reclaiming that object. Therefore, you must hold on to the callback yourself if you need it, and you cannot rely on the table holding it back.

The way you use `EndOfCallRegistry` depends on whether you are dealing with objects held in `static` fields or instance fields.

Static fields

Use `EndOfCallRegistry` to clear state associated with an entire class. In this case, the `Callback` object should be held in a `private static` field. Any code that requires access to the cached data that was dropped between calls must call a method that lazily creates, or re-creates, the cached data.

Consider the following example:

```
import oracle.aurora.memoryManager.Callback;
import oracle.aurora.memoryManager.EndOfCallRegistry;

class Example
{
    static Object cachedField = null;
    private static Callback thunk = null;

    static void clearCachedField()
    {
        // clear out both the cached field, and the thunk so they don't
        // take up session space between calls
        cachedField = null;
        thunk = null;
    }

    private static Object getCachedField()
    {
        if (cachedField == null)
        {
            // save thunk in static field so it doesn't get reclaimed
            // by garbage collector
            thunk = new Callback () {
                public void act(Object obj)
                {
                    Example.clearCachedField();
                }
            };
        }

        // register thunk to clear cachedField at end-of-call.
        EndOfCallRegistry.registerCallback(thunk);
        // finally, set cached field
        cachedField = createCachedField();
    }
}
```

```
    }  
    return cachedField;  
}  
  
private static Object createCachedField()  
{  
    ...  
}  
}
```

The preceding example does the following:

1. Creates a `Callback` object within a static field, `thunk`.
2. Registers this `Callback` object for end-of-call migration.
3. Implements the `Callback.act()` method to free up all static variables, including the `Callback` object itself.
4. Provides a method, `createCachedField()`, for lazily re-creating the cache.

When you create the cache, the `Callback` object is automatically registered within the `getCachedField()` method. At end-of-call, Oracle JVM calls the registered `Callback.act()` method, which frees the static memory.

Instance fields

Use `EndOfCallRegistry` to clear state in data structures held in instance fields. For example, when a state is associated with each instance of a class, each instance has a field that holds the cached state for the instance and fills in the cached field as necessary. You can access the cached field with a method that ensures the state is cached.

Consider the following example:

```
import oracle.aurora.memoryManager.Callback;  
import oracle.aurora.memoryManager.EndOfCallRegistry;  
  
class Example2 implements Callback  
{  
    private Object cachedField = null;  
  
    public void act (Object obj)  
    {  
        // clear cached field  
        cachedField = null;  
        obj = null;  
    }  
  
    // our accessor method  
    private static Object getCachedField()  
    {  
        if (cachedField == null)  
        {  
            // if cachedField is not filled in then you must  
            // register self, and fill it in.  
            EndOfCallRegistry.registerCallback(self);  
            cachedField = createCachedField();  
        }  
        return cachedField;  
    }  
}
```

```

private Object createCachedField()
{
    ...
}
}

```

The preceding example does the following:

1. Implements the instance as a `Callback` object.
2. Implements the `Callback.act()` method to free up the instance fields.
3. When you request a cache, the `Callback` object registers itself for the end-of-call migration.
4. Provides a method, `createCachedField()`, for lazily re-creating the cache.

When you create the cache, the `Callback` object is automatically registered within the `getCachedField()` method. At end-of-call, Oracle JVM calls the registered `Callback.act()` method, which frees the cache.

This approach ensures that the lifetime of the `Callback` object is identical to the lifetime of the instance, because they are the same object.

2.13.3 The `EndOfCallRegistry.registerCallback()` Method

The `registerCallback()` method installs a `Callback` object within a registry. At the end of the call, Oracle JVM calls the `act()` method of all registered `Callback` objects.

You can register your `Callback` object by itself or with an `Object` instance. If you need additional information stored within an object to be passed into `act()`, then you can register this object with the `value` parameter, which is an instance of `Object`.

The following are the valid signatures of the `registerCallback()` method:

```
public static void registerCallback(Callback thunk, Object value);
```

```
public static void registerCallback(Callback thunk);
```

The following table lists the parameters of `registerCallback` and their description:

Parameter	Description
<code>thunk</code>	The <code>Callback</code> object to be called at the end-of-call migration.
<code>value</code>	If you need additional information stored within an object to be passed into <code>act()</code> , then you can register this object with the <code>value</code> parameter. In some cases, the <code>value</code> parameter is necessary to hold the state that the callback needs. However, most users do not need to specify a value for this parameter.

2.13.4 The `EndOfCallRegistry.runCallbacks()` Method

The signature of the `runCallbacks()` method is as follows:

```
static void runCallbacks()
```

JVM calls this method at end-of-call and calls `act()` for every `Callback` object registered using `registerCallback()`. It is called at end-of-call, before object migration and before the last finalization step.



Note:

Do not call this method in your code.

2.13.5 The Callback Interface

The interface is declared as follows:

```
Interface oracle.aurora.memoryManager.Callback
```

Any object you want to register using `EndOfCallRegistry.registerCallback()` must implement the `Callback` interface. This interface can be useful in your application, where you require notification at end-of-call.

2.13.6 The Callback.act() method

The signature of the `act()` method is as follows:

```
public void act(Object value)
```

You can implement any activity that you require to occur at the end of the call. Usually, this method contains procedures for clearing any memory that would be saved to session space.

2.13.7 Operating System Resources Affected Across Calls

In the shared server mode, Oracle JVM closes any open operating system resources at the end of a database call, as shown in the following table:

Resource	Lifetime
Files	The system closes all files left open when a database call ends.
Threads	All threads are terminated when a call ends.
Sockets	<ul style="list-style-type: none"> Client sockets can exist across calls. Server sockets terminate when the call ends.
Objects that depend on operating system resources	<p>Regardless of the usable lifetime of the object, the Java object can be valid for the duration of the session. This can occur, for example, if the Java object is stored in a <code>static</code> class variable, or a class variable references it directly or indirectly. If you attempt to use one of these Java objects after its usable lifetime is over, then Oracle Database will throw an exception. This is true for the following examples:</p> <ul style="list-style-type: none"> If an attempt is made to read from a <code>java.io.FileInputStream</code> that was closed at the end of a previous call, then a <code>java.io.IOException</code> is raised. <code>java.lang.Thread.isAlive()</code> is false for any <code>Thread</code> object running in a previous call and still accessible in a subsequent call.

You should close resources that are local to a single call when the call ends. However, for `static` objects that hold on to operating system resources, you must be aware of how these resources are affected after the call ends.

Files

In the shared server mode, Oracle JVM automatically closes open operating system constructs when the call ends. This can affect any operating system resources within your Java object. If you have a file opened within a `static` variable, then the file handle is closed at the end of the call for you. Therefore, if you hold on to the `File` object across calls, then the next usage of the file handle throws an exception.

In the following example, the `Concat` class enables multiple files to be written into a single file, `outFile`. On the first call, `outFile` is created. The first input file is opened, read, written to `outFile`, and the call ends. Because `outFile` is defined as a `static` variable, it is moved into session space between call invocations. However, the file handle is closed at the end of the call. The next time you call `addFile()`, you will get an exception.

Example 2-5 Compromising Your Operating System Resources

```
public class Concat
{
    static File outFile = new File("outme.txt");
    FileWriter out = new FileWriter(outFile);

    public static void addFile(String[] newFile)
    {
        File inFile = new File(newFile);
        FileReader in = new FileReader(inFile);
        int i;

        while ((i = in.read()) != -1)
            out.write(i);
        in.close();
    }
}
```

There are workarounds. To ensure that your handles stay valid, close your files, buffers, and so on, at the end of every call, and reopen the resource at the beginning of the next call. Another option is to use the database rather than using operating system resources. For example, try to use database tables rather than a file. Alternatively, do not store operating system resources within `static` objects that are expected to live across calls. Instead, use operating system resources only within objects local to the call.

The following example shows how you can perform concatenation, without compromising your operating system resources. The `addFile()` method opens the `outme.txt` file within each call, ensuring that anything written into the file is appended to the end. At the end of each call, the file is closed. Two things occur:

- The `File` object no longer exists outside a call.
- The operating system resource, the `outme.txt` file, is reopened for each call. If you had made the `File` object a `static` variable, then the closing of `outme.txt` within each call would ensure that the operating system resource is not compromised.

Example 2-6 Correctly Managing Your Operating System Resources

```

public class Concat
{
    public static void addFile(String[] newFile)
    {
        /*open the output file each call; make sure the input*/
        /*file is written out to the end by making it "append=true"*/
        FileWriter out = new FileWriter("outme.txt", TRUE);
        File inFile = new File(newFile);
        FileReader in = new FileReader(inFile);
        int i;

        while ((i = in.read()) != -1)
            out.write(i);
        in.close();

        /*close the output file between calls*/
        out.close();
    }
}

```

Sockets

Sockets are used in setting up a connection between a client and a server. For each database connection, sockets are used at either end of the connection. Your application does not set up the connection. The connection is set up by the underlying networking protocol, TTC or IIOIP of Oracle Net.

**See Also:**

"[Configuring Oracle JVM](#)" for information about how to configure your connection.

You may also want to set up another connection, for example, connecting to a specified URL from within one of the classes stored within the database. To do so, instantiate sockets for servicing the client and server sides of the connection using the following:

- The `java.net.Socket()` constructor creates a client socket.
- The `java.net.ServerSocket()` constructor creates a server socket.

A socket exists at each end of the connection. The server side of the connection that listens for incoming calls is serviced by a `ServerSocket` instance. The client side of the connection that sends requests is serviced through a `Socket` instance. You can use sockets as defined within JVM with the restriction that a `ServerSocket` instance within a shared server cannot exist across calls.

The following table lists the socket types and their description:

Socket Type	Description
Socket	Because the client side of the connection is outbound, the <code>Socket</code> instance can be serviced across calls within a shared server.

Socket Type	Description
ServerSocket	The server side of the connection is a listener. The <code>ServerSocket</code> instance is closed at the end of a call within a shared server. The shared servers move on to another client at the end of every call. You will receive an I/O exception stating that the socket was closed, if you try to use the <code>ServerSocket</code> instance outside of the call it was created in.

Threads

In the shared server mode, when a call ends because of a return or uncaught exceptions, Oracle JVM throws `ThreadDeathException` in all daemon threads. `ThreadDeathException` essentially forces threads to stop running. Code that depends on threads living across calls does not behave as expected in the shared server mode. For example, the value of a `static` variable that tracks initialization of a thread may become incorrect in subsequent calls because all threads are killed at the end of a database call.

As a specific example, the standard RMI Server functions in the shared server mode. However, it is useful only within the context of a single call. This is because the RMI Server forks daemon threads, which are in the shared server mode, are killed at the end of call, that is, the daemon thread are killed when all non-daemon threads return. If the RMI server session is reentered in a subsequent call, then these daemon threads are not restarted and the RMI server fails to function properly.

3

Calling Java Methods in Oracle Database

This chapter provides an overview and examples of calling Java methods that reside in Oracle Database. It contains the following sections:

- [Invoking Java Methods](#)
- [How To Tell You Are Running on the Server](#)
- [About Redirecting Output on the Server](#)

3.1 Invoking Java Methods

The type of the Java application determines how the client calls a Java method. The following sections discuss each of the Java application programming interfaces (APIs) available for calling a Java method:

- [Using PL/SQL Wrappers](#)
- [About JNI Support](#)
- [About Utilizing SQLJ and JDBC with Java in the Database](#)
- [About Using the Command-Line Interface](#)
- [Overview of Using the Client-Side Stub](#)

3.1.1 Using PL/SQL Wrappers

You can run Java stored procedures in the same way as PL/SQL stored procedures. In Oracle Database, Java is usually invoked through PL/SQL interface.

To call a Java stored procedure, you must publish it through a call specification. The following example shows how to create, resolve, load, and publish a simple Java stored procedure that returns a string:

1. Define a class, `Hello`, as follows:

```
public class Hello
{
    public static String world()
    {
        return "Hello world";
    }
}
```

Save the file as a `Hello.java` file.

2. Compile the class on your client system using the standard Java compiler, as follows:

```
javac Hello.java
```

It is a good idea to specify the `CLASSPATH` on the command line with the `javac` command, especially when writing shell scripts or make files. The Java compiler produces a Java binary file, in this case, `Hello.class`.

You must determine the location at which this Java code will run. If you run `Hello.class` on your client system, then it searches the `CLASSPATH` for all the supporting core classes that `Hello.class` needs for running. This search should result in locating the dependent classes in one of the following:

- As individual files in one or more directories, where the directories are specified in the `CLASSPATH`
- Within `.jar` or `.zip` files, where the directories containing these files are specified in the `CLASSPATH`

3. Decide on the resolver for the `Hello` class.

In this case, load `Hello.class` on the server, where it is stored in the database as a Java schema object. When you call the `world()` method, Oracle JVM locates the necessary supporting classes, such as `String`, using a resolver. In this case, Oracle JVM uses the default resolver. The default resolver looks for these classes, first in the current schema, and then in `PUBLIC`. All core class libraries, including the `java.lang` package, are found in `PUBLIC`. You may need to specify different resolvers. You can trace problems earlier, rather than at run time, by forcing resolution to occur when you use the `loadjava` tool.

4. Load the class on the server using the `loadjava` tool. You must specify the user name and password. Run the `loadjava` tool as follows:

```
loadjava -user HR Hello.class
Password: password
```

5. Publish the stored procedure through a call specification.

To call a Java `static` method with a SQL call, you must publish the method with a call specification. A call specification defines the arguments that the method takes and the SQL types that it returns.

In `SQL*Plus`, connect to the database and define a top-level call specification for `Hello.world()` as follows:

```
sqlplus HR
Enter password: password
connected
SQL> CREATE OR REPLACE FUNCTION helloworld RETURN VARCHAR2 AS
  2  LANGUAGE JAVA NAME 'Hello.world () return java.lang.String';
  3  /
Function created.
```

6. Call the stored procedure, as follows:

```
SQL> VARIABLE myString VARCHAR2(20);
SQL> CALL helloworld() INTO :myString;
Call completed.
SQL> PRINT myString;

MYSTRING
-----
Hello world

SQL>
```

The call `helloworld() into :myString` statement performs a top-level call in Oracle Database. SQL and PL/SQL see no difference between a stored procedure that is written in Java, PL/SQL, or any other language. The call specification provides a means to tie inter-language calls together in a consistent manner. Call specifications are necessary only for entry points that are called with triggers or SQL and PL/SQL calls. Furthermore, JDeveloper can automate the task of writing call specifications.

Related Topics

- [Overview of Resolving Class Dependencies](#)
- [Schema Objects and Oracle JVM Utilities](#)
- [Developing Java Stored Procedures](#)

3.1.2 About JNI Support

The Java Native Interface (JNI) is a standard programming interface for writing Java native methods and embedding the JVM into native applications. The primary goal of JNI is to provide binary compatibility of Java applications that use platform-specific native libraries.

Native methods can cause server failure, violate security, and corrupt data. Oracle Database does not support the use of JNI in Java applications. If you use JNI, then your application is not 100 percent pure Java and the native methods require porting between platforms.

3.1.3 About Utilizing SQLJ and JDBC with Java in the Database

You can use SQLJ and Java Database Connectivity (JDBC) APIs from a Java client. Both APIs establish a session with a given user name and password on the database and run SQL queries against the database. The following table lists the APIs and their description:

API	Description
JDBC	Use this API for more complex or dynamic SQL queries. JDBC requires you to establish the session, construct the query, and so on.
SQLJ	Use this API for easy SQL queries, both static and dynamic. SQLJ typically runs against a known table with known column names.

This section covers the following topics:

- [Using JDBC](#)
- [Using SQLJ](#)
- [Example Comparing JDBC and SQLJ](#)
- [SQLJ Strong Typing Paradigm](#)
- [Translating a SQLJ Program](#)
- [Interaction with PL/SQL](#)

3.1.3.1 Using JDBC

JDBC is an industry-standard API that lets you embed SQL statements as Java method arguments. JDBC is based on the X/Open SQL Call Level Interface (CLI) and complies with the Entry Level of SQL-92 standard. Each vendor, such as Oracle, creates its JDBC implementation by implementing the interfaces of the standard `java.sql` package. Oracle provides the following JDBC drivers that implement these standard interfaces:

- The JDBC Thin driver, a 100 percent pure Java solution that you can use for either client-side applications or applets and requires no Oracle client installation.
- The JDBC OCI driver, which you use for client-side applications and requires an Oracle client installation.
- The server-side JDBC driver embedded in Oracle Database.

Using JDBC is a step-by-step process of performing the following tasks:

1. Obtaining a connection handle
2. Creating a statement object of some type for your desired SQL operation
3. Assigning any local variables that you want to bind to the SQL operation
4. Carrying out the operation
5. Optionally retrieving the result sets

This process is sufficient for many applications, but becomes cumbersome for any complicated statements. Dynamic SQL operations, where the operations are not known until run time, require JDBC. However, in typical applications, this represents a minority of the SQL operations.



See Also:

Oracle Database JDBC Developer's Guide

3.1.3.2 Using SQLJ

SQLJ offers an industry-standard way to embed any static SQL operation directly into the Java source code in one simple step, without requiring the multiple steps of JDBC. Oracle SQLJ complies with the X3H2-98-320 American National Standards Institute (ANSI) standard.

SQLJ consists of a translator, which is a precompiler that supports standard SQLJ programming syntax, and a run-time component. After creating your SQLJ source code in a `.sqlj` file, you process it with the translator. The translator translates the SQLJ source code to standard Java source code, with SQL operations converted to calls to the SQLJ run time. In Oracle Database SQLJ implementation, the translator calls a Java compiler to compile the Java source code. When your SQLJ application runs, the SQLJ run time calls JDBC to communicate with the database.

SQLJ also enables you to catch errors in your SQL statements before run time. JDBC code, being pure Java, is compiled directly. The compiler cannot detect SQL errors. On the other hand, when you translate SQLJ code, the translator analyzes the

embedded SQL statements semantically and syntactically, catching SQL errors during development, instead of allowing an end user to catch them when running the application.

Following is a complete example of a simple SQLJ program:

```
import java.sql.*;
import sqlj.runtime.ref.DefaultContext;
import oracle.sqlj.runtime.Oracle;

#sql iterator MyIter (String first_name, int employee_id, float salary);

public class MyExample
{
    public static void main (String args[]) throws SQLException
    {
        Oracle.connect("jdbc:oracle:thin:@localhost:5521:orcl", "HR", "<password>");
        #sql { INSERT INTO employees (first_name, employee_id, salary) VALUES ('SMITH',
32, 20000) };
        MyIter iter;
        #sql iter={ SELECT first_name, employee_id, salary FROM employees };
        while (iter.next())
        {
            System.out.println(iter.first_name()+" "+iter.employee_id()+" "+iter.salary());
        }
    }
}
```

In the preceding example, you perform the following:

1. Declare your iterators.

SQLJ uses a strongly-typed version of JDBC result sets, known as iterators. An iterator has a specific number of columns of specific data types. You must define your iterator types before using them, as in this example.

```
#sql ITERATOR MyIter (String first_name, int employee_id, float salary);
```

This declaration results in SQLJ creating an iterator class, `MyIter`. Iterators of type `MyIter` can store results whose first column maps to a Java `String`, second column maps to a Java `int`, and third column maps to a Java `float`. This definition also names the three columns as `first_name`, `employee_id`, and `salary`, to match the column names of the referenced table in the database. `MyIter` is a named iterator.

2. Connect to the database.

```
Oracle.connect("jdbc:oracle:thin:@localhost:5521:orcl", "HR", "<password>");
```

SQLJ provides the `Oracle` class and its `connect()` method accomplishes the following important tasks:

- a. Registers Oracle JDBC drivers that SQLJ uses to access the database, in this case, the JDBC Thin driver.
- b. Opens a database connection for the specified schema, in this case, user `HR` with the specified password, at the specified URL. In this case, the URL points to host `localhost`, port `5521`, and SID `orcl`.
- c. Establishes this connection as the default connection for the SQLJ statements. Although each JDBC statement must explicitly specify a connection object, a

SQLJ statement can either implicitly use a default connection or optionally specify a different connection.

3. Process a SQL statement. The following is accomplished:

a. Insert a row into the employees table:

```
#sql {INSERT INTO employees (first_name, employee_id, salary) VALUES
('SMITH', 32, 20000)};
```

b. Instantiate and populate the iterator:

```
MyIter iter;
#sql iter={SELECT first_name, employee_id, salary FROM employees};
```

4. Access the data that was populated within the iterator.

```
while (iter.next())
{
    System.out.println(iter.first_name()+" "+iter.employee_id()+" "+iter.salary());
}
```

The `next()` method is common to all iterators and plays the same role as the `next()` method of a JDBC result set, returning `true` and moving to the next row of data, if any rows remain. You can access the data in each row by calling iterator accessor methods whose names match the column names. This is a characteristic of all named iterators. In this example, you access the data using the methods `first_name()`, `employee_id()`, and `salary()`.



See Also:

Oracle Database SQLJ Developer's Guide

3.1.3.3 Example Comparing JDBC and SQLJ

The following is an example of a JDBC code and a SQLJ code that perform a simple operation:

JDBC:

```
// Assume you already have a JDBC Connection object conn
// Define Java variables
String name;
int id=37115;
float salary=20000;

// Set up JDBC prepared statement.
PreparedStatement pstmt = conn.prepareStatement
("SELECT first_name FROM employees WHERE employee_id=? AND salary>?");
pstmt.setInt(1, id);
pstmt.setFloat(2, salary);

// Execute query; retrieve name and assign it to Java variable.
ResultSet rs = pstmt.executeQuery();
while (rs.next())
{
    name=rs.getString(1);
    System.out.println("Name is: " + name);
}
```

```

}

// Close result set and statement objects.
rs.close()
pstmt.close();

```

Assume that you have established a JDBC connection, `conn`. Next, you must do the following:

1. Define the Java variables, `name`, `id`, and `salary`.
2. Create a `PreparedStatement` instance.

You can use a prepared statement whenever values in the SQL statement must be dynamically set. You can use the same prepared statement repeatedly with different variable values. The question marks (?) in the prepared statement are placeholders for Java variables. In the preceding example, these variables are assigned values using the `pstmt.setInt()` and `pstmt.setFloat()` methods. The first ? refers to the `int` variable `id` and is set to a value of 37115. The second ? refers to the `float` variable `salary` and is set to a value of 20000.

3. Run the query and return the data into a `ResultSet` object.
4. Retrieve the data of interest from the `ResultSet` object and display it. In this case, the `first_name` column. A result set usually contains multiple rows of data, although this example has only one row.

SQLJ:

```

String name;
int id=37115;
float salary=20000;
#sql {SELECT first_name INTO :name FROM employees WHERE employee_id=:id AND
salary>:salary};
System.out.println("Name is: " + name);

```

In addition to allowing SQL statements to be directly embedded in Java code, SQLJ supports Java host expressions, also known as bind expressions, to be used directly in the SQL statements. In the simplest case, a host expression is a simple variable, as in this example. However, more complex expressions are allowed as well. Each host expression is preceded by colon (:). This example uses Java host expressions, `name`, `id`, and `salary`. In SQLJ, because of its host expression support, you do not need a result set or equivalent when you are returning only a single row of data.

Note:

All SQLJ statements, including declarations, start with the `#sql` token.

3.1.3.4 SQLJ Strong Typing Paradigm

SQLJ uses strong typing, such as iterators, instead of result sets. This enables the SQL instructions to be checked against the database during translation. For example, SQLJ can connect to a database and check your iterators against the database tables that will be queried. The translator will verify that they match, enabling you to catch SQL errors during translation that would otherwise not be caught until a user runs your

application. Furthermore, if changes are subsequently made to the schema, then you can determine if these changes affect the application by rerunning the translator.

3.1.3.5 Translating a SQLJ Program

Integrated development environments (IDEs), such as Oracle JDeveloper, can translate, compile, and customize your SQLJ program as you build it. Oracle JDeveloper is a Microsoft Windows-based visual development environment for Java programming. If you are not using an IDE, then use the front-end SQLJ utility, `sqlj`. You can run it as follows:

```
%sqlj MyExample.sqlj
```

The SQLJ translator checks the syntax and semantics of your SQL operations. You can enable online checking to check your operations against the database. If you choose to do this, then you must specify an example database schema in your translator option settings. It is not necessary for the schema to have data identical to the one that the program will eventually run against. However, the tables must have columns with corresponding names and data types. Use the user option to enable online checking and specify the user name, password, and URL of your schema, as in the following example:

```
%sqlj -user=HR@jdbc:oracle:thin:@localhost:5521:orcl MyExample.sqlj  
Password: password
```

3.1.3.6 Interaction with PL/SQL

All Oracle JDBC drivers communicate seamlessly with Oracle SQL and PL/SQL, and it is important to note that SQLJ interoperates with PL/SQL. You can start using SQLJ without having to rewrite any PL/SQL stored procedures. Oracle SQLJ includes syntax for calling PL/SQL stored procedures and also lets you embed anonymous PL/SQL blocks in SQLJ statements.

3.1.4 About Using the Command-Line Interface

The command-line interface to Oracle JVM is analogous to using the JDK or JRE shell commands. You can:

- Use the standard `-classpath` syntax to indicate where to find the classes to load
- Set the system properties by using the standard `-D` syntax

The interface is a PL/SQL function that takes a string (`VARCHAR2`) argument, parses it as a command-line input and if it is properly formed, runs the indicated Java method in Oracle JVM. To do this, PL/SQL package `DBMS_JAVA` provides the following functions:

- [runjava](#)
- [runjava_in_current_session](#)

runjava

This function takes the Java command line as its only argument and runs it in Oracle JVM. The return value is null on successful completion, otherwise an error message. The format of the command line is the same as that taken by the JDK shell command, that is:

```
[option switches] name_of_class_to_execute [arg1 arg2 ... argn]
```

You can use the option switches `-classpath`, `-D`, `-Xbootclasspath`, and `-jar`. This function differs from the `runjava_in_current_session` function in that it clears any Java state remaining from previous use of Java in the session, prior to running the current command. This is necessary, in particular, to guarantee that static variable values derived at class initialization time from `-classpath` and `-D` arguments reflect the values of those switches in the current command line.

```
FUNCTION runjava(cmdline VARCHAR2) RETURN VARCHAR2;
```

runjava_in_current_session

This function is the same as the `runjava` function, except that it does not clear Java state remaining from previous use of Java in the session, prior to executing the current command line.

```
FUNCTION runjava_in_current_session(cmdline VARCHAR2) RETURN VARCHAR2;
```

Syntax

The syntax of the command line is of the following form:

```
[-options] classname [arguments...]  
[-options] -jar jarfile [arguments...]
```

Options

```
-classpath  
-D  
-Xbootclasspath  
-Xbootclasspath/a  
-Xbootclasspath/p  
-cp
```

Note:

The effect of the first form is to run the main method of the class identified by `classname` with the arguments. The effect of the second form is to run the main method of the class identified by the `Main-Class` attribute in the manifest of the JAR file identified by `JAR`. This is analogous to how the JDK/JRE interprets this syntax.

Argument Summary

The following table summarizes the command-line arguments.

Table 3-1 Command Line Argument Summary

Argument	Description
<code>classpath</code>	Accepts a colon (:) separated (semicolon-separated on Windows systems) list of directories, JAR archives, and ZIP archives to search for class files. In general, the value of <code>-classpath</code> or similar arguments refer to file system locations as they would in a standard Java runtime. You also have an extension to this syntax to allow for terms that refer to database resident Java objects and sets of bytes.

Table 3-1 (Cont.) Command Line Argument Summary

Argument	Description
D	Establishes values for system properties when there is no existing Java session state. The default behavior of the command-line interface, that is, the <code>runjava</code> function, is to terminate any existing Java session prior to running the new command. On the other hand, the alternative function, <code>runjava_in_current_session</code> leaves any existing session in place. So, values established with the <code>-D</code> option always take effect when <code>runjava</code> function is used, but the values may not take effect when <code>runjava_in_current_session</code> function is used.
Xbootclasspath	Accepts a colon (:) separated (semicolon-separated on Windows systems) list of directories, JAR archives, and ZIP archives. This option is used to set search path for bootstrap classes and resources.
Xbootclasspath/a	Accepts a colon (:) separated (semicolon-separated on Windows systems) list of directories, JAR archives, and ZIP archives. This is appended to the end of bootstrap class path.
Xbootclasspath/p	Accepts a colon (:) separated (semicolon-separated on Windows systems) list of directories, JAR archives, and ZIP archives. This is added in front of bootstrap class path.
cp	Acts as a synonym of <code>-classpath</code> .

**Note:**

System classes created by `create java system` are always used before using any file or folder that are found using the `-Xbootclasspath` option.

Related Topics

- [About Using the Command-Line Interface](#)

3.1.5 Overview of Using the Client-Side Stub

Oracle Database 10g introduced the client-side stub, formerly known as native Java interface, for calls to server-side Java code. It is a simplified application integration. Client-side and middle-tier Java applications can directly call Java in the database without defining a PL/SQL wrapper. The client-side stub uses the server-side Java class reflection capability.

In previous releases, calling Java stored procedures and functions from a database client required Java Database Connectivity (JDBC) calls to the associated PL/SQL wrappers. Each wrapper had to be manually published with a SQL signature and a Java implementation. This had the following disadvantages:

- The signatures permitted only Java types that had direct SQL equivalents
- Exceptions issued in Java were not properly returned

Starting from Oracle Database 12c Release 2 (12.2.0.1), you can use the Oracle JVM Web Services Call-Out Utility for generating the client-side stub.

Related Topics

- [Architecture of Oracle JVM Web Services Call-Out Utility](#)

3.1.5.1 Using the Default Service Feature

Starting from Oracle Database 11g release 1 (11.1), Oracle Database client provides a new default connection feature. If you install Oracle Database client, then you need not specify all the details of the database server in the connection URL. Under certain conditions, Oracle Database connection adapter requires only the host name of the computer where the database is installed.

For example, in the JDBC connection URL syntax, that is:

```
jdbc:oracle:driver_type:[username/password]@[//]host_name[:port][:ORCL]
```

,the following have become optional:

- `//` is optional.
- `:port` is optional.

You must specify a port only if the default Oracle Net listener port (1521) is not used.

- `:ORCL` or the service name is optional.

The connection adapter for Oracle Database Client connects to the default service on the host. On the host, this is set to `ORCL` in the `listener.ora` file.

Note:

Default service is a feature since Oracle Database 11g Release 1 (11.1). If you use any version prior to Oracle Database 11g Client to connect to the database, then you must specify the `SID`.

3.1.5.2 Testing the Default Service with a Basic Configuration

The following code snippet shows a basic configuration of the `listener.ora` file, where the default service is defined:

```
MYLISTENER = (ADDRESS_LIST=(ADDRESS=(PROTOCOL=tcp)(HOST=testserver1)(PORT=1521)))
DEFAULT_SERVICE_MYLISTENER=dbjf.app.myserver.com
SID_LIST_MYLISTENER = (SID_LIST=(SID_DESC=(SID_NAME=dbjf)
(GLOBAL_DBNAME=dbjf.app.myserver.com)(ORACLE_HOME=/test/oracle))
)
```

After defining the `listener.ora` file, restart the listener with the following command:

```
lsnrctl start mylistener
```

Now, any of the following URLs should work with this configuration of the `listener.ora` file:

- `jdbc:oracle:thin:@//testserver1.myserver.com.com`
- `jdbc:oracle:thin:@//testserver1.myserver.com:1521`

- `jdbc:oracle:thin:@testserver1.myserver.com`
- `jdbc:oracle:thin:@testserver1.myserver.com:1521`
- `jdbc:oracle:thin:@(DESCRIPTION=(ADDRESS=(PROTOCOL=TCP)(HOST=testserver1.myserver.com)(PORT=1521)))`
- `jdbc:oracle:thin:@(DESCRIPTION=(ADDRESS=(PROTOCOL=TCP)(HOST=testserver1.myserver.com)))`
- `jdbc:oracle:thin:@(DESCRIPTION=(ADDRESS=(PROTOCOL=TCP)(HOST=testserver1.myserver.com)(PORT=1521))(CONNECT_DATA=(SERVICE_NAME=)))`

3.2 How To Tell Whether You Are Running on the Server

You may want to write Java code that runs in a certain way on the server and in another way on the client. In general, Oracle does not recommend this. In fact, JDBC enable you to write portable code that avoids this problem, even though the drivers used in the server and client are different.

If you want to determine whether your code is running on the server, then use the `System.getProperty()` method, as follows:

```
System.getProperty ("oracle.jserver.version")
```

The `getProperty()` method returns the following:

- A `String` that represents Oracle Database release, if running on the server
- `null`, if running on the client

3.3 About Redirecting Output on the Server

You can pass Java output to SQL statements to provide more extensive control over the destination of output from Oracle JVM. The PL/SQL package `DBMS_JAVA` has been enhanced by adding the following new functions, which provide extended functionality to what was previously available only with the `DBMS_JAVA.SET_OUTPUT` procedure:

- [set_output_to_sql](#)
- [remove_output_to_sql](#)
- [enable_output_to_sql](#)
- [disable_output_to_sql](#)
- [query_output_to_sql](#)

set_output_to_sql

`set_output_to_sql` defines a named output specification that constitutes an instruction for executing a SQL statement, whenever output to the default `System.out` and `System.err` streams occurs. The specification is defined either for the duration of the current session, or till the `remove_output_to_sql` function is called with its ID. The SQL actions prescribed by the specification occur whenever there is Java output. This can be stopped and started by calling the `disable_output_to_sql` and `enable_output_to_sql` functions respectively. The return value of this function is `null` on success, otherwise an error message.

```

FUNCTION set_output_to_sql (id VARCHAR2,
stmt VARCHAR2,
bindings VARCHAR2,
no_newline_stmt VARCHAR2 default null,
no_newline_bindings VARCHAR2 default null,
newline_only_stmt VARCHAR2 default null,
newline_only_bindings VARCHAR2 default null,
maximum_line_segment_length NUMBER default 0,
allow_replace NUMBER default 1,
from_stdout NUMBER default 1,
from_stderr NUMBER default 1,
include_newlines NUMBER default 0,
eager NUMBER default 0) return VARCHAR2;

```

Table 3-2 describes the arguments the `set_output_to_sql` function takes.

Table 3-2 set_output_to_sql Argument Summary

Argument	Description
<code>id</code>	The name of the specification. Multiple specifications may exist in the same session, but each must have a distinct ID. The ID is used to identify the specification in the functions <code>remove_output_to_sql</code> , <code>enable_output_to_sql</code> , <code>disable_output_to_sql</code> , and <code>query_output_to_sql</code> .
<code>stmt</code>	The default SQL statement to execute when Java output occurs.
<code>bindings</code>	A string containing tokens from the set <code>ID</code> , <code>TEXT</code> , <code>LENGTH</code> , <code>LINENO</code> , <code>SEGNO</code> , <code>NL</code> , and <code>ERROUT</code> . This string defines how the SQL statement <code>stmt</code> is bound. The position of a token in the bindings string corresponds to the bind position in the SQL statement. The meanings of the tokens are: <ul style="list-style-type: none"> • <code>ID</code> is the ID of the specification. It is bound as a <code>VARCHAR2</code>. • <code>TEXT</code> is the text being output. It is bound as a <code>VARCHAR2</code>. • <code>LENGTH</code> is the length of the text. It is bound as a <code>NUMBER</code>. • <code>LINENO</code> is the line number since the beginning of session output. It is bound as a <code>NUMBER</code>. • <code>SEGNO</code> is the segment number within a line that is being output in more than one piece. It is bound as a <code>NUMBER</code>. • <code>NL</code> is a boolean indicating whether the text is to be regarded as newline terminated. It is bound as a <code>NUMBER</code>. The newline may or may not actually be included in the text, depending on the value of the <code>include_newlines</code> argument. • <code>ERROUT</code> is a boolean indicating whether the output came from <code>System.out</code> or <code>System.err</code>. It is bound as a <code>NUMBER</code>. The value is 0, if the output came from <code>System.out</code>.
<code>no_newline_stmt</code>	An optional alternate SQL statement to execute, when the output is not newline terminated.
<code>no_newline_bindings</code>	A string with the same syntax as for the <code>bindings</code> argument discussed previously, describing how the <code>no_newline_stmt</code> is bound.
<code>newline_only_stmt</code>	An optional alternate SQL statement to execute when the output is a single newline.
<code>newline_only_bindings</code>	A string with the same syntax as for the <code>bindings</code> argument discussed previously, describing how the <code>newline_only_stmt</code> is bound.

Table 3-2 (Cont.) set_output_to_sql Argument Summary

Argument	Description
maximum_line_segment_length	The maximum number of characters that is bound in a given execution of the SQL statement. Longer output sequences are broken up into separate calls with distinct SEGNO values. A value of 0 means no maximum.
allow_replace	Controls behavior when a previously defined specification with the same ID exists. A value of 1 means replacing the old specification. 0 means returning an error message without modifying the old specification.
from_stdout	Controls whether output from <code>System.out</code> causes execution of the SQL statement prescribed by the specification. A value of 0 means that if the output came from <code>System.out</code> , then the statement is not executed, even if the specification is otherwise enabled.
from_stderr	Controls whether output from <code>System.err</code> causes execution of the SQL statement prescribed by the specification. A value of 0 means that if the output came from <code>System.err</code> , then the statement is not executed, even if the specification is otherwise enabled.
include_newlines	Controls whether newline characters are left in the output when they are bound to text. A value of 0 means new lines are not included. But the presence of the newline is still indicated by the NL binding and the use of <code>no_newline_stmt</code> .
eager	Controls whether output not terminated by a newline causes execution of the SQL statement every time it is received, or accumulates such output until a newline is received. A value of 0 means that unterminated output is accumulated.

remove_output_to_sql

`remove_output_to_sql` deletes a specification created by `set_output_to_sql`. If no such specification exists, an error message is returned.

```
FUNCTION remove_output_to_sql (id VARCHAR2) return VARCHAR2;
```

enable_output_to_sql

`enable_output_to_sql` reenables a specification created by `set_output_to_sql` and subsequently disabled by `disable_output_to_sql`. If no such specification exists, an error message is returned. If the specification is not currently disabled, there is no change.

```
FUNCTION enable_output_to_sql (id VARCHAR2) return VARCHAR2;
```

disable_output_to_sql

`disable_output_to_sql` disables a specification created by `set_output_to_sql`. You can enable the specification by calling `enable_output_to_sql`. While disabled, the SQL statement prescribed by the specification is not executed. If no such specification exists, an error message is returned. If the specification is already disabled, there is no change.

```
FUNCTION disable_output_to_sql (id VARCHAR2) return VARCHAR2;
```

query_output_to_sql

`query_output_to_sql` returns a message describing a specification created by `set_output_to_sql`. If no such specification exists, then an error message is returned. Passing `null` to this function causes all existing specifications to be displayed.

```
FUNCTION query_output_to_sql (id VARCHAR2) return VARCHAR2;
```

Another way of achieving control over the destination of output from Oracle JVM is to pass your Java output to an autonomous Java session. This provides a very general mechanism for propagating the output to various kinds of targets, such as disk files, sockets, and URLs. But, you must keep in mind that the Java session that processes the output is logically distinct from the main session, so that there are no other, unwanted interactions between them. To do this, PL/SQL package `DBMS_JAVA` provides the following functions:

- [set_output_to_java](#)
- [remove_output_to_java](#)
- [enable_output_to_java](#)
- [disable_output_to_java](#)
- [query_output_to_java](#)
- [set_output_to_file](#)
- [remove_output_to_file](#)
- [enable_output_to_file](#)
- [disable_output_to_file](#)
- [query_output_to_file](#)

set_output_to_java

`set_output_to_java` defines a named output specification that gives an instruction for executing a Java method whenever output to the default `System.out` and `System.err` streams occurs. The Java method prescribed by the specification is executed in a separate VM context with separate Java session state from the rest of the session.

```
FUNCTION set_output_to_java (id VARCHAR2,  
    class_name VARCHAR2,  
    class_schema VARCHAR2,  
    method VARCHAR2,  
    bindings VARCHAR2,  
    no_newline_method VARCHAR2 default null,  
    no_newline_bindings VARCHAR2 default null,  
    newline_only_method VARCHAR2 default null,  
    newline_only_bindings VARCHAR2 default null,  
    maximum_line_segment_length NUMBER default 0,  
    allow_replace NUMBER default 1,  
    from_stdout NUMBER default 1,  
    from_stderr NUMBER default 1,  
    include_newlines NUMBER default 0,  
    eager NUMBER default 0,  
    initialization_statement VARCHAR2 default null,  
    finalization_statement VARCHAR2 default null) return VARCHAR2;
```

Table 3-3 describes the arguments the `set_output_to_java` method takes.

Table 3-3 set_output_to_java Argument Summary

Argument	Description
<code>class_name</code>	The name of the class defining one or more methods.
<code>class_schema</code>	The schema in which the class is defined. A null value means the class is defined in the current schema, or PUBLIC.
<code>method</code>	The name of the method.
<code>bindings</code>	A string that defines how the arguments to the method are bound. This is a string of tokens with the same syntax as <code>set_output_to_sql</code> . The position of a token in the string determines the position of the argument it describes. All arguments must be of type INT, except for those corresponding to the tokens ID or TEXT, which must be of type <code>java.lang.String</code> .
<code>no_newline_method</code>	An optional alternate method to execute when the output is not newline terminated.
<code>newline_only_method</code>	An optional alternate method to execute when the output is a single newline.
<code>initialization_statement</code>	An optional SQL statement that is executed once per Java session prior to the first time the methods that receive output are executed. This statement is executed in same Java VM context as the output methods are executed. Typically such a statement is used to run a Java stored procedure that initializes conditions in the separate VM context so that the methods that receive output can function as intended. For example, such a procedure might open a stream that the output methods write to.
<code>finalization_statement</code>	An optional SQL statement that is executed once when the output specification is about to be removed or the session is ending. Like the <code>initialization_statement</code> , this runs in the same JVM context as the methods that receive output. It runs only if the initialization method has run, or if there is no initialization method.

remove_output_to_java

`remove_output_to_java` deletes a specification created by `set_output_to_java`. If no such specification exists, an error message is returned

```
FUNCTION remove_output_to_java (id VARCHAR2) return VARCHAR2;
```

enable_output_to_java

`enable_output_to_java` reenables a specification created by `set_output_to_java` and subsequently disabled by `disable_output_to_java`. If no such specification exists, an error message is returned. If the specification is not currently disabled, there is no change.

```
FUNCTION enable_output_to_java (id VARCHAR2) return VARCHAR2;
```

disable_output_to_java

`disable_output_to_java` disables a specification created by `set_output_to_java`. The specification may be reenabled by `enable_output_to_java`. While disabled, the SQL statement prescribed by the specification is not executed. If no such specification

exists, an error message is returned. If the specification is already disabled, there is no change.

```
FUNCTION disable_output_to_java (id VARCHAR2) return VARCHAR2;
```

query_output_to_java

`query_output_to_java` returns a message describing a specification created by `set_output_to_java`. If no such specification exists, an error message is returned. Passing `null` to this function causes all existing specifications to be displayed.

```
FUNCTION query_output_to_java (id VARCHAR2) return VARCHAR2;
```

set_output_to_file

`set_output_to_file` defines a named output specification that constitutes an instruction to capture any output sent to the default `System.out` and `System.err` streams and append it to a specified file. This is implemented using a special case of `set_output_to_java`. The argument `file_path` specifies the path to the file to which to append the output. The arguments `allow_replace`, `from_stdout`, and `from_stderr` are all analogous to the arguments having the same name as in `set_output_to_sql`.

```
FUNCTION set_output_to_file (id VARCHAR2,  
file_path VARCHAR2,  
allow_replace NUMBER default 1,  
from_stdout NUMBER default 1,  
from_stderr NUMBER default 1) return VARCHAR2;
```

remove_output_to_file

This function is analogous to `remove_output_to_java`.

```
FUNCTION remove_output_to_file (id VARCHAR2) return VARCHAR2;
```

enable_output_to_file

This function is analogous to `enable_output_to_java`.

```
FUNCTION enable_output_to_file (id VARCHAR2) return VARCHAR2;
```

disable_output_to_file

This function is analogous to `disable_output_to_java`.

```
FUNCTION disable_output_to_file (id VARCHAR2) return VARCHAR2;
```

query_output_to_file

This function is analogous to `query_output_to_java`.

```
FUNCTION query_output_to_file (id VARCHAR2) return VARCHAR2;
```

The following `DBMS_JAVA` functions control whether Java output appears in the `.trc` file:

- PROCEDURE `enable_output_to_trc`;
- PROCEDURE `disable_output_to_trc`;
- FUNCTION `query_output_to_trc` return VARCHAR2;



Note:

Prior to 11g release 1 (11.1), the fact that Java output appeared in the `.trc` file was not modifiable.

Redirecting the output to SQL*Plus Text Buffer

As in previous releases, you can use the `DBMS_JAVA` package procedure `SET_OUTPUT` to redirect output to the SQL*Plus text buffer:

```
SQL> SET SERVEROUTPUT ON  
SQL> CALL dbms_java.set_output(2000);
```

The minimum and default buffer size is 2,000 bytes and the maximum size is 1,000,000 bytes. In the following example, the buffer size is increased to 5,000 bytes:

```
SQL> SET SERVEROUTPUT ON SIZE 5000  
SQL> CALL dbms_java.set_output(5000);
```

The output is displayed at the end of the call.

4

Java Installation and Configuration

This chapter describes how to install and configure Oracle JVM. It also describes how to enable the Java client. This chapter covers the following topics:

- [About Initializing a Java-Enabled Database](#)
- [Configuring Oracle JVM](#)
- [The DBMS_JAVA Package](#)
- [Enabling the Java Client](#)
- [Two-Tier Duration for Java Session State](#)
- [About Setting System Properties](#)

4.1 Initializing a Java-Enabled Database

If you install Oracle Database with Oracle JVM option, then the database is Java-enabled. That is, it is ready to run Java stored procedures and Java Database Connectivity (JDBC).

This section contains the following topics:

- [Configuring the Oracle JVM Option within the Oracle Database Template](#)
- [Modifying an Existing Oracle Database to Include Oracle JVM](#)

4.1.1 Configuring the Oracle JVM Option within the Oracle Database Template

Configure Oracle JVM option within the database template. This is the recommended method for Java installation.

The Database Configuration Assistant enables you to create database templates for defining what each database instance installation will contain. Choose Oracle JVM option to have the Java platform installed within your database.

4.1.2 Modifying an Existing Oracle Database to Include Oracle JVM

If you have already installed Oracle Database without Oracle JVM, then you can add Java to your database through the modify mode of the Database Configuration Assistant of Oracle Database 12c Release 1 (12.1). The modify mode enables you to choose the features, such as Oracle JVM, that you would like to install on top of an existing Oracle Database instance.

4.2 Configuring Oracle JVM

Before you install Oracle JVM as part of your standard Oracle Database installation, you must ensure that the configuration requirements for Oracle JVM are fulfilled. The main configuration for Java classes within Oracle Database includes configuring the:

- Java memory requirements

You must have at least 50 MB of `JAVA_POOL_SIZE` and 96 MB of `SHARED_POOL_SIZE`.

 **Note:**

Oracle recommends that you increase the `JAVA_POOL_SIZE` and `SHARED_POOL_SIZE` values when using large Java applications, or when a large number of users are running Java in the database.

- Database processes

You must decide whether to use dedicated server processes or shared server processes for your database server.

 **Note:**

Oracle recommends that you use dedicated servers. Shared server incurs extra Java states save in the database session, in SGA, at the end of the Java call.

Related Topics

- [About Java Memory Usage](#)

4.3 The DBMS_JAVA Package

Installing Oracle JVM creates the `DBMS_JAVA` PL/SQL package. The `DBMS_JAVA` package functions can be used by both Database server and Database clients. The corresponding Java class, `DbmsJava`, provides methods for accessing database functionality from Java.

Related Topics

- [DBMS_JAVA Package](#)

4.4 Enabling the Java Client

To run Java between the client and server, your must perform the following activities:

1. [Installing Java SE on the Client](#)
2. [Setting Up Environment Variables](#)

4.4.1 Installing Java SE on the Client

The client requires Java Development Kit (JDK) 1.6 or later. To confirm the version of JDK you are using, run the following commands on the command line:

```
$ which java
/usr/local/jdk1.6.0_26/bin/java

$ which javac
/usr/local/jdk1.6.0_26/bin/javac

$ java -version
java version "1.6.0_26"
```

4.4.2 Setting Up Environment Variables

After installing JDK on your client, add the directory path to the following environment variables:

- `$JAVA_HOME`
This variable must be set to the top directory of the installed JDK base.
- `$PATH`
This variable must include `$JAVA_HOME/bin`.
- `$LD_LIBRARY_PATH`
This variable must include `$JAVA_HOME/lib`.

JAR Files Necessary for Java Clients

To ensure that the Java client successfully communicates with the server, include the following files in the `CLASSPATH`:

 **Note:**

Specifics of `CLASSPATH` requirements may vary for Oracle JVMs running on different platforms. You must ensure that all elements of `CLASSPATH`, as defined in the script for Oracle JVM utilities, are present.

- For JDK 8, include `$JAVA_HOME/lib/dt.jar`
- For JRE 8, include `$JAVA_HOME/lib/rt.jar`
- For any interaction with JDBC, include `$ORACLE_HOME/jdbc/lib/ojdbc8.jar`
- For any client that uses SSL, include `$ORACLE_HOME/jlib/jssl-1_2.jar` and `$ORACLE_HOME/jlib/javax-ssl-1_2.jar`
- For any client that uses the Java Transaction API (JTA) functionality, include `$ORACLE_HOME/jlib/jta.jar`
- For any client that uses the Java Naming and Directory Interface (JNDI) functionality, include `$ORACLE_HOME/jlib/jndi.jar`

Server Application Development on the Client

If you develop and compile your server applications on the client and want to use the same Java Archive (JAR) files that are loaded on the server, then include `$ORACLE_HOME/lib/aurora.zip` in `CLASSPATH`. This is not required for running Java clients.

4.5 Two-Tier Duration for Java Session State

Prior to 11g release 1 (11.1), Java session state was single-tier, which included all values associated with running Java, such as System property values and static variable values, the set of classes loaded during the session and so on. The duration of this state used to start with the first invocation of a Java method in the RDBMS session and it used to last till JVM exited, either due to a call to `java.lang.System.exit` or similar `OracleRuntime` methods, an uncaught exception, a fatal error, or the end of the RDBMS session. This required modifying Java code and also failed to fully complete the termination of the session before the end of the RDBMS call. This made it impossible to start a new Java session within the same call.

Starting with 11g release 1 (11.1), Java session state is split into two tiers. One tier has a longer duration and it encompasses the duration of the other tier. The duration of the shorter tier is the same as before, that is, it starts when a Java method is invoked and ends when JVM exits. The duration of the longer tier starts when a Java method is invoked in the RDBMS session for the first time. This session lasts until the RDBMS session ends or the session is explicitly terminated by a call to the function `dbms_java.endsession_and_related_state`. This is addressed by the addition of the following two PL/SQL functions to the `DBMS_JAVA` package, which account for the two kinds of Java session duration:

- `FUNCTION endsession RETURN VARCHAR2;`

This function clears any Java session state remaining from previous execution of Java in the current RDBMS session. The return value is a message indicating the action taken.

- `FUNCTION endsession_and_related_state RETURN VARCHAR2;`

This function clears any Java session state remaining from previous execution of Java in the current RDBMS session and all supporting data related to running Java, such as property settings and output specifications. The return value is a message indicating the action taken.

Most of the values associated with running Java remain in the shorter tier. The values that can be useful for multiple invocations of JVM have been moved to the longer tier. For example, the system property values established by `dbms_java.set_property` and the output redirection specifications.

Related Topics

- [About Setting System Properties](#)
- [About Redirecting Output on the Server](#)

4.6 About Setting System Properties

Within an RDBMS session you can maintain a set of values that are added to the system properties whenever a Java session is started in the RDBMS session. This set

of values remains valid for the duration of the longer tier of Java session state, which is typically the same as the duration of the RDBMS session.

There is a set of PL/SQL functions in the `DBMS_JAVA` package for setting, retrieving, removing and displaying key value pairs in an internal, RDBMS session duration table, where both elements of a pair are strings (`VARCHAR2`) and there is at most one pair for a given key. These functions are as follows:

- [set_property](#)
- [get_property](#)
- [remove_property](#)
- [show_property](#)

set_property

This function establishes a value for a system property that is then used for the duration of the current RDBMS session, whenever a Java session is initialized. The first argument is the name of the property and the second is the value to be established for it. The return value for `set_property` is null unless there is some error. For example, if an attempt is made to set a value for a prescribed property, then an error message is returned.

```
FUNCTION set_property(name VARCHAR2, value VARCHAR2) RETURN VARCHAR2;
```

get_property

This function returns any value previously established by `set_property`. It returns null if there is no such value.

```
FUNCTION get_property(name VARCHAR2) RETURN VARCHAR2;
```

remove_property

This function removes any value previously established by `set_property`. The return value is null unless an error occurred, in which case an error message is returned.

```
FUNCTION remove_property(name VARCHAR2) RETURN VARCHAR2;
```

show_property

This function displays a message of the form `name = value` for the input name, or for all established property bindings, if name is null. The return value for this function is null on successful completion, otherwise it is an error message. The output is displayed to wherever you have currently directed your Java output.

```
FUNCTION show_property(name VARCHAR2) RETURN VARCHAR2;
```

Before initializing the Java session, the values from this table are added to the set of default system property values already maintained by Oracle JVM. When you run a Java method by using the command-line interface, the values determined by the `-D` option, if present, override the values set in the table. As soon as you terminate the Java session, the values established by the `-D` option become obsolete and the keys are set to the original values as present in the table.

Related Topics

- [Two-Tier Duration for Java Session State](#)

5

Introduction to Nashorn JavaScript Engine

Nashorn JavaScript engine enables running JavaScript directly in the database. The ability to reuse existing client-side JavaScript in the database, and then combining it with the Java SE libraries, enables the design of rich, powerful, and versatile data-bound applications that can run directly in RDBMS sessions. This section describes the Nashorn JavaScript Engine in the following sections:

- [About Using Nashorn JavaScript Engine](#)
- [JavaScript Data Access using JDBC](#)
- [REST Enable Your JavaScript Application](#)

5.1 About Using Nashorn JavaScript Engine

One of the important features of Java 8 is the Nashorn JavaScript engine. Starting from Oracle Database 12c Release 2 (12.2.0.1), Oracle JVM supports Java 8, so you can execute JavaScript in the database using the Nashorn JavaScript engine, built into Oracle JVM running Java 8 codebase. Executing JavaScript directly in the database provides the following benefits:



See Also:

<https://docs.oracle.com/javase/8/docs/technotes/guides/scripting/nashorn/api.html>

Benefits of Running JavaScript in Oracle Database

- Reusing existing skills and code.
- Avoiding shipping data residing in Oracle Database. Executing JavaScript in the database enables in-place and faster processing of JSON documents inside the database. This enables avoiding shipping data to external infrastructure and improving performance as network overhead is avoided.
- Achieving new database capabilities.

For running JavaScript code, using the Nashorn engine of 12.2 Oracle JVM in your sessions, your schema must be granted the DBJAVASCRIPT role. This role includes the permissions that are required to run Nashorn in the database. The role can be granted by your DBA and must be done only once per user.

The preferred way to maintain JavaScript sources in Oracle Database is to load them into your schema as Java resources and then run the scripts within the database.

 **Note:**

- The direct invocation of Nashorn classes is restricted in Oracle JVM.
- All scripting mode extensions are disabled in Oracle JVM.
- You can run scripts either from strings or from file streams, using standard scripting APIs, but Oracle does not recommend it. Scripts invoked in this way can run only in sandboxed mode, with the default permissions.

5.1.1 Loading JavaScript Code into a Schema

Use the `loadjava` command to load your JavaScript code into your database schema. Scripts are loaded as Java resources. For example, suppose you have a JavaScript file `hello.js` as follows:

```
function hello()
{
/*
*This is a sample Javascript file that prints "Hello World".
*/
var hellow = "Hello World";
return hellow;
}

var output = hello();
print(output);
```

Use the following command to load the `hello.js` script file into a schema named `yourschema`:

```
loadjava -v -u yourschema hello.js
```

The `loadjava` command prompts you for a password and then creates a schema-local resource `hello.js` with the following output:

```
arguments: '-u' 'yourschema/****' '-v' 'hello.js'
creating  : resource hello.js
loading   : resource hello.js
Classes Loaded: 0
Resources Loaded: 1
Sources Loaded: 0
Published Interfaces: 0
Classes generated: 0
Classes skipped: 0
Synonyms Created: 0
Errors: 0
```

You can also use the following command to verify whether you have successfully loaded the `hello.js` file into the database or not:

```
select object_name, object_type from user_objects;
```

This resource can then be passed to the Nashorn engine using the ways mentioned in the following sections:

5.1.2 How to run JavaScript in Oracle JVM

After loading the scripts in the database, you can run them in the following three ways:

- [Using the DBMS_JAVASCRIPT.RUN PL/SQL Procedure](#)
- [Using the DbmsJavaScript Java Class](#)
- [Using the Standard javax.script Java Package](#)

5.1.2.1 Using the DBMS_JAVASCRIPT.RUN PL/SQL Procedure

This approach is useful for JavaScript procedures that do not return any value. Invoke the `DBMS_JAVASCRIPT.RUN` procedure for providing the resource name as the argument. Make sure that your schema is granted the `DBJAVASCRIPT` role. The `DBMS_JAVASCRIPT.RUN` procedure is a wrapper for the `oracle.aurora.rdbms.DbmsJavaScript.run` Java method, which invokes Nashorn functionality internally.

From SQL

```
call dbms_javascript.run('hello.js');
```

If your JavaScript code returns an output value, then you must use the following instructions to display the value on the standard output device:

```
SQL>set serveroutput on  
SQL>call dbms_java.set_output(20000);  
SQL>call dbms_javascript.run("hello.js");
```

From PL/SQL:

```
dbms_javascript.run('hello.js');
```

If your JavaScript code returns an output value, then you must use the following instructions to display the value on the standard output device:

```
SQL>set serveroutput on  
SQL>call dbms_java.set_output(20000);  
SQL>call dbms_javascript.run("hello.js");
```

5.1.2.2 Using the DbmsJavaScript Java Class

This is the preferred way to invoke the scripts from Java code in Oracle JVM because it enables you to apply the schema permissions to the JavaScript code. Invoke the JavaScript that you loaded as resource `hello.js` from your Java code running in the database. Invoke the method `run` of `oracle.aurora.rdbms.DbmsJavaScript` class, passing in the resource name as the argument, as shown in the following code snippet:

**Note:**

Make sure that your schema is granted the `DBJAVASCRIPT` role.

```
import oracle.aurora.rdbms.DbmsJavaScript;
...
DbmsJavaScript.run("hello.js");
```

5.1.2.3 Using the Standard `javax.script` Java Package

This approach is useful for JavaScript functions that return values. Typically, you perform the following tasks:

**Note:**

You must make sure that your schema is granted the `DBJAVASCRIPT` role.

1. Load the JavaScript in the database as a Java resource, using the `loadjava` command.
2. Use the `javax.script` package to run the JavaScript.
3. Instantiate a script manager
4. Create an engine
5. Pass your resource stream reader as the argument to the `eval` method of the engine

The following code snippet shows how to use the `javax.script` package to run code from resource `hello.js`:

```
import javax.script.*;
import java.net.*;
import java.io.*;
...

// create a script engine manager
ScriptEngineManager factory = new ScriptEngineManager();
// create a JavaScript engine
ScriptEngine engine =
    factory.getEngineByName("javascript");
// create schema resource URL
```

```
URL url = Thread.currentThread()
    .getContextClassLoader().getResource("hello.js");
engine.eval(new InputStreamReader(url.openStream()));
...
```

You can also read the JavaScript code from a String. The following code snippet shows how to read and evaluate JavaScript code from a String:

```
// evaluate JavaScript code from String
engine.eval(new StringReader(<script>));
```

Otherwise, you can also read the JavaScript code from a file. However, this involves extra privileges. The following code snippet shows how to read and evaluate JavaScript code from the `script_name` file:

```
import javax.script.*;
...
ScriptEngine engine = new ScriptEngineManager()
    .getEngineByName("JavaScript");
engine.eval(new FileReader("script_name"));
```

After evaluating the JavaScript code, you typically perform the following tasks for invoking JavaScript functions:

1. Cast the Nashorn engine to `Invocable` and use `invokeFunction`.

For example, if the `hello.js` script defines a JavaScript function named `hello`, then you can perform these tasks as shown in the following code snippet:

```
// create a JavaScript engine as above
Invocable invocable = (Invocable) engine;
Object myResult = invocable.invokeFunction("hello");
...
```

 **Note:**

An alternative way to use the `invocable.invokeFunction` is to pass the return value to a Java method invoked from inside of a script. This alternative way is preferable as it requires less boilerplate code and is compatible with the `DBMSJAVASCRIPT.RUN` procedure.

For example, suppose your JavaScript resource `hello.js` defines the `selectQuery` function, and you want to pass the result to the `print()` Java method, which is defined in your class `QueryTest` as follows:

```
public static void print (String results) {
    System.out.println("my results: \n" + results);
}
```

Then, to achieve this from JavaScript, add the following lines to the `hello.js` file:

```
var queryTest = Java.type("QueryTest");
queryTest.print(selectQuery("all"));
```

Now, invoke `hello.js` in one of the following ways:

```
DbmsJavaScript.run("hello.js");

DBMS_JAVASCRIPT.RUN('hello.js');
```

2. Create a PL/SQL procedure for invoking the JavaScript application, as shown in the following example:

```
-- Create a procedure for select
CREATE OR REPLACE PROCEDURE selectproc(id IN varchar2)
IS
    output varchar2(10000);
BEGIN
    SELECT invokeScriptEval(id) INTO output from dual;
    http.prn(output);
END;
/
SHOW ERRORS;
```

5.2 JavaScript Data Access using JDBC

This section describes how to access data in RDBMS using JavaScript. Currently, there is no JavaScript standard for accessing data in RDBMS. The Nashorn JavaScript engine enables using standard JDBC within JavaScript.

Perform the following steps to publish your application using JDBC with JavaScript as a service:

1. Create a table in the database and populate it using JSON, as shown in the following example:

```
DROP TABLE employees PURGE;

CREATE TABLE employees (
  id RAW(16) NOT NULL,
  data CLOB,
  CONSTRAINT employees_pk PRIMARY KEY (id),
  CONSTRAINT employees_json_chk CHECK (data IS JSON)
);

TRUNCATE TABLE employees;

INSERT INTO employees (id, data)
VALUES (SYS_GUID(),
       '{
         "EmpId"      : "100",
         "FirstName" : "Kuassi",
         "LastName"  : "Mensah",
         "Job"       : "Manager",
         "Email"     : "kuassi@oracle.com",
         "Address"   : {
           "City"    : "Redwood",
           "Country" : "US"
         }
       }');

INSERT INTO employees (id, data)
VALUES (SYS_GUID(),
       '{
         "EmpId"      : "200",
         "FirstName" : "Nancy",
         "LastName"  : "Greenberg",
         "Job"       : "Manager",
         "Email"     : "Nancy@oracle.com",
         "Address"   : {
           "City"    : "Boston",
           "Country" : "US"
         }
       }');

INSERT INTO employees (id, data)
VALUES (SYS_GUID(),
       '{
         "EmpId"      : "300",
         "FirstName" : "Suresh",
         "LastName"  : "Mohan",
         "Job"       : "Developer",
         "Email"     : "Suresh@oracle.com",
         "Address"   : {
           "City"    : "Bangalore",
           "Country" : "India"
         }
       }');
```

```
INSERT INTO employees (id, data)
VALUES (SYS_GUID(),
       '{
         "EmpId"      : "400",
         "FirstName"  : "Nirmala",
         "LastName"   : "Sundarappa",
         "Job"        : "Manager",
         "Email"      : "Nirmala@oracle.com",
         "Address"    : {
           "City"     : "Redwood",
           "Country"  : "US"
         }
       }');
```

```
INSERT INTO employees (id, data)
VALUES (SYS_GUID(),
       '{
         "EmpId"      : "500",
         "FirstName"  : "Amarnath",
         "LastName"   : "Chandana",
         "Job"        : "Test Devloper",
         "Email"      : "amarnath@oracle.com",
         "Address"    : {
           "City"     : "Bangalore",
           "Country"  : "India"
         }
       }');
```

2. Write a JavaScript application using JDBC, as shown in the following example and load the JavaScript code into a schema:

```
var selectQuery = function(id)
{
  var Driver = Packages.oracle.jdbc.OracleDriver;
  var oracleDriver = new Driver();
  var url = "jdbc:default:connection:";
  var output = "";
  var connection = oracleDriver.defaultConnection();
  var prepStmt;

  // Prepare statement
  if(id == 'all') {
    prepStmt = connection.prepareStatement("SELECT a.data FROM
employees a");
  } else {
    prepStmt = connection.prepareStatement("SELECT a.data FROM
employees a WHERE a.data.EmpId = ?");
    prepStmt.setInt(1, id);
  }

  // execute Query
  var resultSet = prepStmt.executeQuery();

  // display results
  while(resultSet.next()) {
```

```

        output = output + resultSet.getString(1) + "<br>";
    }

    // cleanup
    resultSet.close();
    prepStmt.close();
    connection.close();
    return output;
}

```

3. Create a Java resource, as shown in the following example:

```

create or replace and compile java source named "InvokeScript" as
import javax.script.*;
import java.net.*;
import java.io.*;

public class InvokeScript {
    public static String eval(String inputId) throws Exception {
        String output = new String();
        try {
            // create a script engine manager
            ScriptEngineManager factory = new ScriptEngineManager();

            // create a JavaScript engine
            ScriptEngine engine = factory.getEngineByName("javascript");

            //read the script as a java resource
            engine.eval(new
                InputStreamReader(InvokeScript.class.getResourceAsStream("select.js")));
            // Alternative approach
            //
            engine.eval(Thread.currentThread().getContextClassLoader().getResource("
                select.js"));

            Invocable invocable = (Invocable) engine;
            Object selectResult = invocable.invokeFunction("selectQuery",
                inputId);
            output = selectResult.toString();
        } catch (Exception e) {
            output = e.getMessage();
        }
        return output;
    }
}
/

```

4. Create a wrapper for the eval method of the engine, as shown in the following example:

```

-- Create function
CREATE OR REPLACE FUNCTION invokeScriptEval(inputId varchar2) return
varchar2 as language java

```

```
name 'InvokeScript.eval(java.lang.String) return java.lang.String';  
/
```

5. Invoke the `invokeScriptEval` JavaScript function from SQL, as shown in the following example:

```
CREATE OR REPLACE PROCEDURE sqldemo(id IN varchar2)  
IS  
  output varchar2(10000);  
BEGIN  
  SELECT invokeScriptEval(id) INTO output from dual;  
  dbms_output.put_line(output);  
END;  
/  
SHOW ERRORS;
```

6. Invoke the `sqldemo` procedure from SQL, as shown in the following example:

```
SQL> set serveroutput on  
SQL> call dbms_java.set_output(5000);  
SQL> call sqldemo('100');
```

Related Topics

- [REST Enable Your JavaScript Application](#)

5.3 REST Enable Your JavaScript Application

Perform the following steps to make your JavaScript application a cloud-enabled service using Oracle REST Data Services (ORDS):

1. Download the Oracle REST Data Services (ORDS) installer file from the following location:

<http://www.oracle.com/technetwork/developer-tools/rest-data-services/downloads/index.html>

Note:

- You can perform similar steps for making your Java in the Database application a cloud-enabled service using Oracle REST Data Services (ORDS).
 - For installing ORDS, you must have a `USERS` tablespace with at least 40 MB space.
2. Install ORDS by selecting the default options, except the following:
 - When it prompts whether you want to use PL/SQL Gateway or not, select 2 for skipping the step.
 - When it prompts you to specify passwords for Application Express RESTful Services database users (`APEX_LISTENER`, `APEX_REST_PUBLIC_USER`), select 2 for skipping the step.

- When it prompts whether you wish to start the service in standalone mode or exit, select 1 for starting the service in standalone mode.
3. Assign a listening port to the service. By default, port 8080 is used, but you may change this value in the `ords_params.properties` file under the `.../params` directory. Then, use the following command to bounce the jersey server:

```
java -jar ords.war
```

4. Create a procedure similar to the following as a wrapper to the `invokeScriptEval` method:

```
Rem Create a procedure for select
CREATE OR REPLACE PROCEDURE selectproc(id IN varchar2)
IS
  output varchar2(10000);
BEGIN
  SELECT invokeScriptEval(id) INTO output from dual;
  htp.prn(output);
END;
/
SHOW ERRORS;
```

5. Create a procedure similar to the following for executing an external JavaScript SELECT query:

```
begin
  ords.create_service(
    p_module_name => 'load.routes' ,
    p_base_path   => '/load/routes/' ,
    p_pattern     => 'nashorn/selectbyid/:id' ,
    p_source_type => 'plsql/block' ,
    p_source      => 'begin selectproc(:id); end;'
  );
  commit;
end;
/
```

6. Invoke the service from your browser, where the URL will be of the following format:

```
http://<server>:<port>/ords/<workspace>/load/routes/nashorn/
<your_JSON_query>/<input>
```

For example:

```
http://localhost:8090/ords/ordstest/load/routes/nashorn/selectbyid/100
```

Here, *100* specifies the employee ID of the employee, whose details need to be fetched. The following image illustrates the output:

Figure 5-1 Output of the JavaScript Application



The output is displayed in JSON format.

6

Developing Java Stored Procedures

Oracle JVM has all the features you must build a new generation of enterprise-wide applications at a low cost. The most important feature is the support for stored procedures. Using stored procedures, you can implement business logic at the server level, thereby improving application performance, scalability, and security.

This chapter contains the following sections:

- [Stored Procedures and Run-Time Contexts](#)
- [Advantages of Stored Procedures](#)
- [Running Java Stored Procedures](#)
- [Debugging Java Stored Procedures](#)

6.1 Stored Procedures and Run-Time Contexts

Stored procedures are Java methods published to SQL and stored in the database for general use. To publish Java methods, you write call specifications, which map Java method names, parameter types, and return types to their SQL counterparts.

Unlike a wrapper, which adds another layer of execution, a call specification publishes the existence of a Java method. As a result, when you call the method through its call specification, the run-time system dispatches the call with minimal overhead.

When called by client applications, a stored procedure can accept arguments, reference Java classes, and return Java result values.

[Figure 6-1](#) shows a stored procedure being called by various applications.

Figure 6-1 Calling a Stored Procedure

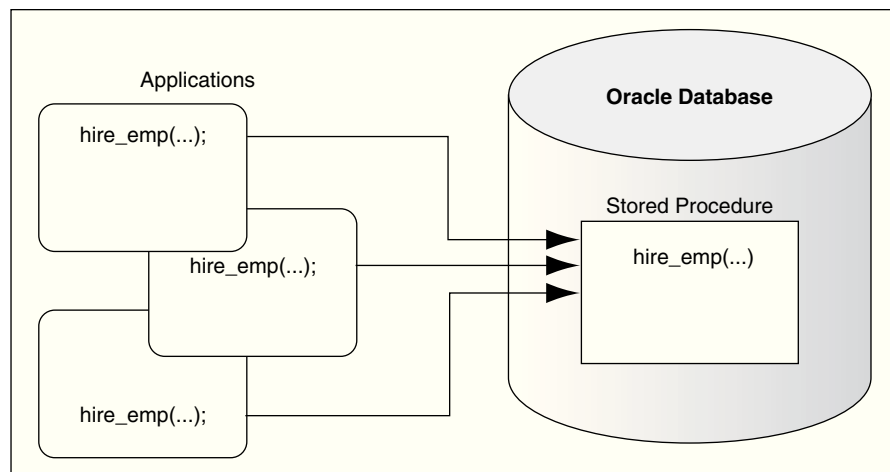

Except for graphical user interface (GUI) methods, Oracle JVM can run any Java method as a stored procedure. The run-time contexts are:

- [Functions and Procedures](#)
- [Database Triggers](#)
- [Object-Relational Methods](#)

6.1.1 Functions and Procedures

Functions and procedures are named blocks that encapsulate a sequence of statements. They are building blocks that you can use to construct modular, maintainable applications.

Generally, you use a procedure to perform an action and a function to compute a value. Therefore, you use procedure call specifications for `void` Java methods and function call specifications for value-returning methods.

Only top-level and package-level PL/SQL functions and procedures can be used as call specifications. When you define them using the SQL `CREATE FUNCTION`, `CREATE PROCEDURE`, or `CREATE PACKAGE` statement, they are stored in the database, where they are available for general use.

Java methods published as functions and procedures must be invoked explicitly. They can accept arguments and are callable from:

- SQL data manipulation language (DML) statements
- SQL `CALL` statements
- PL/SQL blocks, subprograms, and packages

6.1.2 Database Triggers

A database trigger is a stored procedure that is associated with a specific table or view. Oracle Database calls the trigger automatically whenever a given DML operation modifies the table or view.

A trigger has the following parts:

- A triggering event, which is generally a DML operation
- An optional trigger constraint
- A trigger action

When the event occurs, the trigger is called. A `CALL` statement in the trigger calls a Java method through the call specification of the method, to perform the action.

Database triggers are used to enforce complex business rules, derive column values automatically, prevent invalid transactions, log events transparently, audit transactions, and gather statistics.

6.1.3 Object-Relational Methods

A SQL object type is a user-defined composite data type that encapsulates a set of variables, called attributes, with a set of operations, called methods, which can be written in Java. The data structure formed by the set of attributes is `public`. However,

as a good programming practice, you must ensure that your application does not manipulate these attributes directly and uses the set of methods provided.

You can create an abstract template for some real-world object as a SQL object type. The template specifies only those attributes and methods that the object will need in the application environment. At run time, when you fill the data structure with values, you create an instance of the object type. You can create as many instances as required.

Typically, an object type corresponds to some business entity, such as a purchase order. To accommodate a variable number of items, object types can use a `VARRAY`, a nested table, or both.

For example, the purchase order object type can contain a variable number of line items.

6.2 Advantages of Stored Procedures

Stored procedures offer several advantages. The following advantages are covered in this section:

- Performance
- Productivity and Ease of Use
- Scalability
- Maintainability
- Interoperability
- Replication
- Security

6.2.1 Performance

Stored procedures are compiled once and stored in an executable form. As a result, procedure calls are quick and efficient. Executable code is automatically cached and shared among users. This lowers memory requirements and invocation overhead.

By grouping SQL statements, a stored procedure allows the statements to be processed with a single call. This reduces network traffic and improves round-trip response time.

Additionally, stored procedures enable you to take advantage of the computing resources of the server. For example, you can move computation-bound procedures from client to server, where they will run faster. Stored functions enhance performance by running application logic within the server.

6.2.2 Productivity and Ease of Use

By designing applications around a common set of stored procedures, you can avoid redundant coding and increase the productivity. Moreover, stored procedures let you extend the functionality of the database.

You can use the Java integrated development environment (IDE) of your choice to create stored procedures. They can be called by standard Java interfaces, such as Java Database Connectivity (JDBC), and by programmatic interfaces and

development tools, such as SQLJ, Oracle Call Interface (OCI), Pro*C/C++, and JDeveloper.

This broad access to stored procedures lets you share business logic across applications. For example, a stored procedure that implements a business rule can be called from various client-side applications, all of which can share that business rule. In addition, you can leverage the Java facilities of the server while continuing to write applications for a preferred programmatic interface.

6.2.3 Scalability

Java in the database inherits the scalable session model of Oracle Database. Stored procedures increase scalability by isolating application processing on the server. In addition, automatic dependency tracking for stored procedures helps in developing scalable applications.

6.2.4 Maintainability

After a stored procedure is validated, you can use it with confidence in any number of applications. If its definition changes, then only the procedure is affected, not the applications that call it. This simplifies maintenance and enhancement. Also, maintaining a procedure on the server is easier than maintaining copies on different client computers.

6.2.5 Interoperability

Java in Oracle Database fully conforms to the Java Language Specification (JLS) and furnishes all the advantages of a general-purpose, object-oriented programming language. Also, as with PL/SQL, Java provides full access to Oracle data. As a result, any procedure that is written in PL/SQL can also be written in Java.

PL/SQL stored procedures complement Java stored procedures. Typically, SQL programmers who want procedural extensions favor PL/SQL, and Java programmers who want easy access to Oracle data favor Java.

Oracle Database allows a high degree of interoperability between Java and PL/SQL. Java applications can call PL/SQL stored procedures using an embedded JDBC driver. Conversely, PL/SQL applications can call Java stored procedures directly.

6.2.6 Replication

With Oracle Advanced Replication, you can replicate stored procedures from one Oracle Database instance to another. This enables you to use stored procedures to implement a central set of business rules. Once you write the procedures, you can replicate and distribute them to work groups and branch offices throughout the company. In this way, you can revise policies on a central server rather than on individual servers.

6.2.7 Security

Security is a large arena that includes:

- Network security for the connection

- Access and execution control of operating system resources or of JVM and user-defined classes
- Bytecode verification of JAR files imported from an external source.

In Oracle Database, all classes are loaded into a secure database and, therefore, are untrusted. A user requires the appropriate permissions to access classes and operating system resources. Likewise, all stored procedures are secured against other users. You can grant the `EXECUTE` database privilege to users who need to access the stored procedures.

You can restrict access to Oracle data by allowing users to manipulate the data only through stored procedures that run with their definer's privileges. For example, you can allow access to a procedure that updates a database table, but deny access to the table itself.

Related Topics

- [Security for Oracle Database Java Applications](#)

6.3 Running Java Stored Procedures

You can run Java stored procedures in the same way as PL/SQL stored procedures. Usually, a call to a Java stored procedure is a result of database manipulation, because it is usually the result of a trigger or SQL DML call. To call a Java stored procedure, you must publish it through a call specification.

Before you can call Java stored procedures, you must load them into Oracle Database instance and publish them to SQL. Loading and publishing are separate tasks. Many Java classes, which are referenced only by other Java classes, are never published.

To load Java stored procedures automatically, you can use the `loadjava` tool. It loads Java source, class, and resource files into a system-generated database table, and then uses the SQL `CREATE JAVA {SOURCE | CLASS | RESOURCE}` statement to load the Java files into Oracle Database instance. You can upload Java files from file systems, popular Java IDEs, intranets, or the Internet.

You must perform the following steps for creating, loading, and calling Java stored procedures:

- [Creating or Reusing the Java Classes](#)
- [Loading and Resolving the Java Classes](#)
- [Publishing the Java Classes](#)
- [Calling the Stored Procedures](#)

Note:

To load Java stored procedures manually, you can use the `CREATE JAVA` statements. For example, in SQL*Plus, you can use the `CREATE JAVA CLASS` statement to load Java class files from local `BFILE` and `LOB` columns into Oracle Database.

6.3.1 Creating or Reusing the Java Classes

Use a preferred Java IDE to create classes, or reuse existing classes that meet your requirements. Oracle Database supports many Java development tools and client-side programmatic interfaces. For example, Oracle JVM accepts programs developed in popular Java IDEs, such as Oracle JDeveloper, Symantec Visual Cafe, and Borland JBuilder.

In the following example, you create the `public class Oscar`. It has a single method named `quote()`, which returns a quotation from Oscar Wilde.

```
public class Oscar
{
    // return a quotation from Oscar Wilde
    public static String quote()
    {
        return "I can resist everything except temptation.";
    }
}
```

Save the class as `Oscar.java`. Using a Java compiler, compile the `.java` file on your client system, as follows:

```
javac Oscar.java
```

The compiler outputs a Java binary file, in this case, `Oscar.class`.

6.3.2 Loading and Resolving the Java Classes

Using the `loadjava` tool, you can load Java source, class, and resource files into Oracle Database instance, where they are stored as Java schema objects. You can run the `loadjava` tool from the command line or from an application, and you can specify several options including a resolver.

In the following example, the `loadjava` tool connects to the database using the default JDBC OCI driver. You must specify the user name and password. By default, the `Oscar` class is loaded into the schema of the user you log in as, in this case, `HR`.

```
$ loadjava -user HR Oscar.class
Password: password
```

When you call the `quote()` method, the server uses a resolver to search for supporting classes, such as `String`. In this case, the default resolver is used. The default resolver first searches the current schema and then the `SYS` schema, where all the core Java class libraries reside. If necessary, you can specify different resolvers.

6.3.3 Publishing the Java Classes

For each Java method that can be called from SQL or JDBC, you must write a call specification, which exposes the top-level entry point of the method to Oracle Database. Typically, only a few call specifications are needed. If preferred, you can generate these call specifications using Oracle JDeveloper.

In the following example, from `SQL*Plus`, you connect to the database and then define a top-level call specification for the `quote()` method:

```
SQL> connect HR
Enter password: password

SQL> CREATE FUNCTION oscar_quote RETURN VARCHAR2
2 AS LANGUAGE JAVA
3 NAME 'Oscar.quote()' return java.lang.String';
```

Related Topics

- [Publishing Java Classes With Call Specifications](#)

6.3.4 Calling the Stored Procedures

You can call Java stored procedures from JDBC, SQLJ, and all third party languages that can access the call specification. Using the SQL `CALL` statement, you can also call the stored procedures from the top level, for example, from SQL*Plus. Stored procedures can also be called from database triggers.

In the following example, you declare a SQL*Plus host variable:

```
SQL> VARIABLE theQuote VARCHAR2(50);
```

Then, you call the function `oscar_quote()`, as follows:

```
SQL> CALL oscar_quote() INTO :theQuote;
```

```
SQL> PRINT theQuote;
```

```
THEQUOTE
```

```
-----
I can resist everything except temptation.
```

You can also call the Java class using the `ojvmjava` tool.

Related Topics

- [Calling Stored Procedures](#)
- [The ojvmjava Tool](#)

6.4 Debugging Java Stored Procedures

Oracle Database provides the Java Debug Wire Protocol (JDWP) interface for debugging Java stored procedures. JDWP is supported by Java Development Kit (JDK) 1.3 and later versions.

Following are a few features that the JDWP interface supports:

- Listening for connections
- Changing the values of variables while debugging
- Evaluating arbitrary Java expressions, including method evaluations
- Setting or clearing breakpoints on a line or in a method
- Stepping through the code
- Setting or clearing field access or modification watchpoints

 **Note:**

Oracle JDeveloper provides a user-friendly integration with these debugging features. Other independent Integrated Development Environment (IDE) vendors can also integrate their own debuggers with Oracle Database.

This section discusses the following topics:

- [Prerequisites for Debugging Java Stored Procedures](#)
- [Debugging Java Stored Procedures Using the jdb Debugger](#)
- [Debugging Java Stored Procedures Using JDeveloper](#)

6.4.1 Prerequisites for Debugging Java Stored Procedures

Ensure that the following prerequisites are met before debugging a Java stored procedure:

- The Java code must be deployed to the database and can be optionally compiled with debug information.
- Your database user account must have the following privileges:
 - The `DEBUG CONNECT SESSION` privilege
 - The `DEBUG CONNECT ANY` privilege
 - The `DEBUG CONNECT ON USER <user>` privilege
 - The `DEBUG` object privilege on the stored procedure to be debugged
- You must add the `jdwp` privilege to the Access Control List (ACL) in the following way:

```
SQL> begin
2   DBMS_NETWORK_ACL_ADMIN.APPEND_HOST_ACE(
3     host => <host_name>,
4     ace  => xs$ace_type(privilege_list => xs$name_list('jdwp'),
5                        principal_name => <user_name>,
6                        principal_type => xs_acl.ptype_db));
7 end;
8 /
```

 **See Also:**

Oracle Database Security Guide for more information about adding privileges to an Access Control List

6.4.2 Debugging Java Stored Procedures Using the jdb Debugger

A `jdb` session can be started with the `-listen <port>` command. If you start the session in this way, then `jdb` waits for a running Virtual Machine (VM) to connect at the specified port, using the standard connector.

 **Note:**

While debugging a Java stored procedure, `jdb` cannot launch a JVM session and only waits for the VM to connect.

Perform the following steps to debug a Java program running in Oracle JVM:

1. Run the following command in the debugging terminal:

```
jdb -listen 4000
```

The following image shows the debugging terminal starting the `jdb` session:

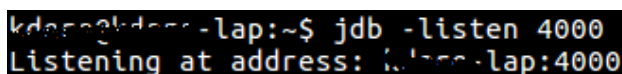

```
kdora@kdora-lap:~$ jdb -listen 4000
Listening at address: localhost:4000
```

2. Use an Oracle client such as SQL*Plus to issue the command for connecting to the debugger. You can connect in the following two ways:
 - Issue the debugger connection command from the same session that executes your Java stored procedure. For example, if you are using SQL*Plus, then issue the following command to open a TCP/IP connection to the designated machine and port for the JDWP session:

```
EXEC DBMS_DEBUG_JDWP.CONNECT_TCP(<host_ip>, <port>)
```

The following image shows the client terminal running the command for connecting to the debugging terminal:

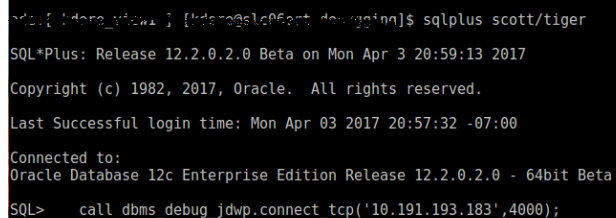

```
kdora@kdora-lap:~$ sqlplus scott/tiger
SQL*Plus: Release 12.2.0.2.0 Beta on Mon Apr 3 20:59:13 2017
Copyright (c) 1982, 2017, Oracle. All rights reserved.
Last Successful login time: Mon Apr 03 2017 20:57:32 -07:00

Connected to:
Oracle Database 12c Enterprise Edition Release 12.2.0.2.0 - 64bit Beta
SQL> call dbms_debug_jdwp.connect_tcp('10.191.193.183',4000);
```

After the debugger accepts the connection, issue the breakpoint in the debugger session and invoke the Java stored procedure in the Oracle client. The debugger will now halt at the first breakpoint that you specified.

- Issue the debugger connection command in another session and specify two additional parameters as shown in the following example:

```
EXEC DBMS_DEBUG_JDWP.CONNECT_TCP(<host_ip>, <port>,
<session_id>, <session_serial>)
```

In the preceding command, `session_id` and `session_serial` identify the database session, where the Java stored procedure is executed, which the user wants to connect to the debugger. To connect another session to the debugger, the user must have either `DEBUG CONNECT` user privilege on the logon user of that session, or the `DEBUG CONNECT ANY` system privilege.

3. Once connection is established successfully, you can add breakpoints in the debugging terminal using the following syntax:

```
stop at <ClassName>:<LineNumber>
```

The following image shows how to add breakpoints to the debugging terminal:

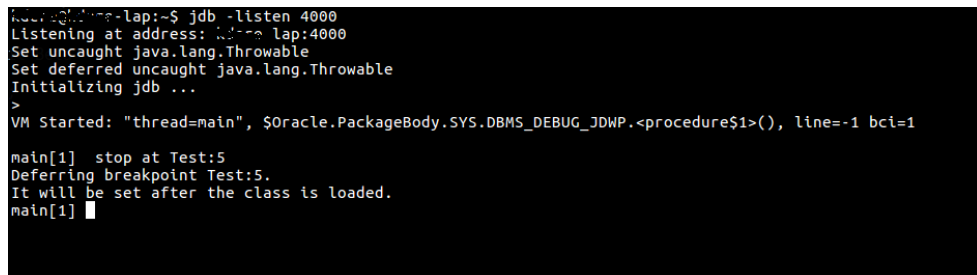

```

SQL*Plus> sqlplus user@orcl:oracle> jdb -listen 4000
Listening at address: localhost:4000
Set uncaught java.lang.Throwable
Set deferred uncaught java.lang.Throwable
Initializing jdb ...
>
VM Started: "thread=main", $Oracle.PackageBody.SYS.DBMS_DEBUG_JDWP.<procedure$1>(), line=-1 bci=1
main[1] stop at Test:5
Deferring breakpoint Test:5.
It will be set after the class is loaded.
main[1] █

```

4. In the Oracle client used in step 2, call the SQL wrapper for the Java program in the following way:

```
call <SQLWrapperName>.<MethodName>
```

5. Following are a few `jdb` commands that you can use to debug the code in the debugging terminal:
 - For Going one step at a time: `step`
 - To check the value of a variable value: `print<ClassName>:<VariableName>`
 - To continue: `cont`
 - To clear break points: `clear`

6.4.3 Debugging Java Stored Procedures Using JDeveloper

You can debug Java stored procedures and PL/SQL programs seamlessly using JDeveloper. When you debug PL/SQL programs and Java stored procedures locally, then the call to initiate debugging is made directly from JDeveloper. JDeveloper performs the following activities:

1. It automatically launches the program that you want to debug (also called debuggee)
2. It attaches the debugger to that program.

The main difference between remote debugging and local debugging PL/SQL programs and Java stored procedures is how you start the debugging session. For remote debugging, you must manually launch the program that you want to debug with an Oracle client such as `SQL*Plus`, jobs created using the `DBMS_SCHEDULER` package, an OCI program, or a trigger firing. Then, you must establish the connection from the database program that you want to debug (debuggee) to the JDeveloper debugger.

After the debuggee is launched and the JDeveloper debugger is attached to it, remote debugging is very similar to local debugging.

 **Note:**

You can optionally turn off JIT for better debugging experience.

 **See Also:**

For more information about using JDeveloper for debugging Java stored procedures, visit the following page

[http://docs.oracle.com/cd/E16162_01/user.1112/e17455/
dev_stored_proc.htm#BEJEJHD](http://docs.oracle.com/cd/E16162_01/user.1112/e17455/dev_stored_proc.htm#BEJEJHD)

7

Publishing Java Classes With Call Specifications

When you load a Java class into the database, its methods are not published automatically, because Oracle Database does not know which methods are safe entry points for calls from SQL. To publish the methods, you must write call specifications, which map Java method names, parameter types, and return types to their SQL counterparts. This chapter describes how to publish Java classes with call specifications in the following sections:

- [What Are Call Specifications](#)
- [Defining Call Specifications](#)
- [Writing Top-Level Call Specifications](#)
- [Writing Packaged Call Specifications](#)
- [Writing Object Type Call Specifications](#)

7.1 What Are Call Specifications?

To publish Java methods, you write call specifications. For a given Java method, you declare a function or procedure call specification using the SQL `CREATE FUNCTION` or `CREATE PROCEDURE` statement. Inside a PL/SQL package or SQL object type, you use similar declarations.

You publish Java methods that return a value as functions and `void` Java methods as procedures. The function or procedure body contains the `LANGUAGE JAVA` clause. This clause records information about the Java method including its full name, its parameter types, and its return type. Mismatches are detected only at run time.

The following figure shows applications calling the Java method through its call specification, that is, by referencing the name of the call specification. The run-time system looks up the call specification definition in the Oracle data dictionary and runs the corresponding Java method.

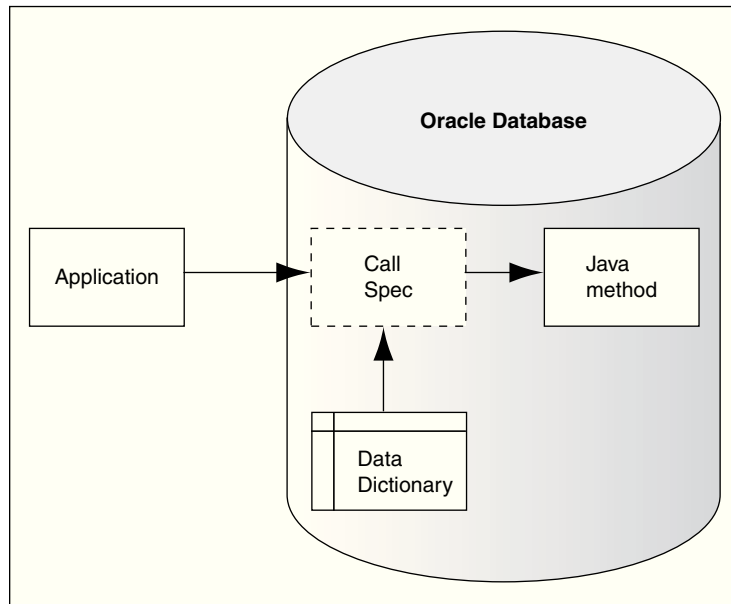
Figure 7-1 Calling a Java Method

As an alternative, you can use the native Java interface to directly call Java methods in the database from a Java client.

Related Topics

- [Overview of Using the Client-Side Stub](#)

7.2 Defining Call Specifications

A call specification and the Java method it publishes must reside in the same schema, unless the Java method has a `PUBLIC` synonym. You can declare the call specification as a:

- Standalone PL/SQL function or procedure
- Packaged PL/SQL function or procedure
- Member method of a SQL object type

A call specification exposes the top-level entry point of a Java method to Oracle Database. As a result, you can publish only `public static` methods. However, there is an exception. You can publish instance methods as member methods of a SQL object type.

Packaged call specifications perform as well as top-level call specifications. As a result, to ease maintenance, you may want to place call specifications in a package body. This will help you to modify call specifications without invalidating other schema objects. Also, you can overload the call specifications.

This section covers the following topics:

- [About Setting Parameter Modes](#)
- [About Mapping Data Types](#)
- [Using the Server-Side Internal JDBC Driver](#)

7.2.1 About Setting Parameter Modes

In Java and other object-oriented languages, a method cannot assign values to objects passed as arguments. When calling a method from SQL or PL/SQL, to change the value of an argument, you must declare it as an `OUT` or `IN OUT` parameter in the call specification. The corresponding Java parameter must be an array with only one element.

You can replace the element value with another Java object of the appropriate type, or you can modify the value, if the Java type permits. Either way, the new value propagates back to the caller. For example, you map a call specification `OUT` parameter of the `NUMBER` type to a Java parameter declared as `float[] p`, and then assign a new value to `p[0]`.

 **Note:**

A function that declares `OUT` or `IN OUT` parameters cannot be called from SQL data manipulation language (DML) statements.

7.2.2 About Mapping Data Types

In a call specification, the corresponding SQL and Java parameters and function results must have compatible data types.

[Table 7-1](#) lists the legal data type mappings. Oracle Database converts between the SQL types and Java classes automatically.

Table 7-1 Legal Data Type Mappings

SQL Type	Java Class
CHAR, VARCHAR2, LONG	java.lang.String
	oracle.sql.CHAR
	oracle.sql.ROWID
	byte[]

Table 7-1 (Cont.) Legal Data Type Mappings

SQL Type	Java Class
NUMBER	boolean char byte byte[] short int long float double java.lang.Byte java.lang.Short java.lang.Integer java.lang.Long java.lang.Float java.lang.Double java.math.BigDecimal oracle.sql.NUMBER
BINARY_INTEGER	boolean char byte byte[] short int long
BINARY_FLOAT	oracle.sql.BINARY_FLOAT byte[]
BINARY_DOUBLE	oracle.sql.BINARY_DOUBLE byte[]
DATE	oracle.sql.DATE byte[]
RAW	oracle.sql.RAW byte[]
BLOB	oracle.sql.BLOB
CLOB	oracle.sql.CLOB
BFILE	oracle.sql.BFILE
ROWID	oracle.sql.ROWID byte[]

Table 7-1 (Cont.) Legal Data Type Mappings

SQL Type	Java Class
TIMESTAMP	oracle.sql.TIMESTAMP byte[]
TIMESTAMP WITH TIME ZONE	oracle.sql.TIMESTAMPTZ
TIMESTAMP WITH LOCAL TIME ZONE	oracle.sql.TIMESTAMPLTZ
ref cursor	java.sql.ResultSet sqlj.runtime.ResultSetIterator
user defined named types, ADTs	oracle.sql.STRUCT
opaque named types	oracle.sql.OPAQUE
nested tables and VARRAY named types	oracle.sql.ARRAY
references to named types	oracle.sql.REF

You also must consider the following:

- The last four SQL types are collectively referred to as named types.
- All SQL types except BLOB, CLOB, BFILE, REF CURSOR, and the named types can be mapped to the Java type `byte[]`, which is a Java byte array. In this case, the argument conversion means copying the raw binary representation of the SQL value to or from the Java byte array.
- Java classes that implement the `ORADData` interface and related methods, or Java classes that are subclasses of the `oracle.sql` classes appearing in the table, can be mapped from SQL types other than `BINARY_INTEGER` and `REF CURSOR`.
- The `UROWID` type and the `NUMBER` subtypes, such as `INTEGER` and `REAL`, are not supported.
- A value larger than 32 KB cannot be retrieved from a `LONG` or `LONG RAW` column into a Java stored procedure.

7.2.3 Using the Server-Side Internal JDBC Driver

Java Database Connectivity (JDBC) enables you establish a connection to the database using the `DriverManager` class, which manages a set of JDBC drivers. You can use the `getConnection()` method after loading the JDBC drivers. When the `getConnection()` method finds the right driver, it returns a `Connection` object that represents a database session. All SQL statements are run within the context of that session.

However, the server-side internal JDBC driver runs within a default session and a default transaction context. As a result, you are already connected to the database, and all your SQL operations are part of the default transaction. You need not register the driver because it comes preregistered. To get a `Connection` object, run the following line of code:

```
Connection conn = DriverManager.getConnection("jdbc:default:connection:");
```

Use the `Statement` class for SQL statements that do not take `IN` parameters and are run only once. When called on a `Connection` object, the `createStatement()` method returns a new `Statement` object, as follows:

```
String sql = "DROP " + object_type + " " + object_name;
Statement stmt = conn.createStatement();
stmt.executeUpdate(sql);
```

Use the `PreparedStatement` class for SQL statements that take `IN` parameters or are run more than once. The SQL statement, which can contain one or more parameter placeholders, is precompiled. A question mark (?) serves as a placeholder. When called on a `Connection` object, the `prepareStatement()` method returns a new `PreparedStatement` object, which contains the precompiled SQL statement. For example:

```
String sql = "DELETE FROM dept WHERE deptno = ?";
PreparedStatement pstmt = conn.prepareStatement(sql);
pstmt.setInt(1, deptID);
pstmt.executeUpdate();
```

A `ResultSet` object contains SQL query results, that is, the rows that meet the search condition. You can use the `next()` method to move to the next row, which then becomes the current row. You can use the `getXXX()` methods to retrieve column values from the current row. For example:

```
String sql = "SELECT COUNT(*) FROM " + tabName;
int rows = 0;
Statement stmt = conn.createStatement();
ResultSet rset = stmt.executeQuery(sql);
while (rset.next())
{
    rows = rset.getInt(1);
}
```

A `CallableStatement` object lets you call stored procedures. It contains the call text, which can include a return parameter and any number of `IN`, `OUT`, and `IN OUT` parameters. The call is written using an escape clause, which is delimited by braces ({}). As the following examples show, the escape syntax has three forms:

```
// parameterless stored procedure
CallableStatement cstmt = conn.prepareCall("{CALL proc}");

// stored procedure
CallableStatement cstmt = conn.prepareCall("{CALL proc(?,?)}");

// stored function
CallableStatement cstmt = conn.prepareCall("{? = CALL func(?,?)}");
```

Important Points

When developing JDBC applications that access stored procedures, you must consider the following:

- Each Oracle JVM session has a single implicit native connection to the Database session in which it exists. This connection is conceptual and is not a Java object. It is an inherent aspect of the session and cannot be opened or closed from within the JVM.

- The server-side internal JDBC driver runs within a default transaction context. You are already connected to the database, and all your SQL operations are part of the default transaction. Note that this transaction is a local transaction and not part of a global transaction, such as that implemented by Java Transaction API (JTA) or Java Transaction Service (JTS).
- Statements and result sets persist across calls and their finalizers do not release database cursors. To avoid running out of cursors, close all statements and result sets after you have finished using them. Alternatively, you can ask your DBA to raise the limit set by the initialization parameter, `OPEN_CURSORS`.
- The server-side internal JDBC driver does not support auto-commits. As a result, your application must explicitly commit or roll back database changes.
- You cannot connect to a remote database using the server-side internal JDBC driver. You can connect only to the server running your Java program. For server-to-server connections, use the server-side JDBC Thin driver. For client/server connections, use the client-side JDBC Thin or JDBC Oracle Call Interface (OCI) driver.
- Typically, you should not close the default connection instance because it is a single instance that can be stored in multiple places, and if you close the instance, each would become unusable. If it is closed, a later call to the `OracleDriver.defaultConnection` method gets a new, open instance. The `OracleDataSource.getConnection` method returns a new object every time you call it, but, it does not create a new database connection every time. They all utilize the same implicit native connection and share the same session state, in particular, the local transaction.



See Also:

Oracle Database JDBC Developer's Guide

7.3 Writing Top-Level Call Specifications

In SQL*Plus, you can define top-level call specifications interactively, using the following syntax:

```
CREATE [OR REPLACE]
{ PROCEDURE procedure_name [(param[, param]...)]
| FUNCTION function_name [(param[, param]...)] RETURN sql_type}
[AUTHID {DEFINER | CURRENT_USER}]
[PARALLEL_ENABLE]
[DETERMINISTIC]
{IS | AS} LANGUAGE JAVA
NAME 'method_fullname (java_type_fullname[, java_type_fullname]...)'
[return java_type_fullname]';
```

where `param` is represented by the following syntax:

```
parameter_name [IN | OUT | IN OUT] sql_type
```

The `AUTHID` clause determines the following:

- Whether a stored procedure runs with the privileges of its definer (`AUTHID DEFINER`) or invoker (`AUTHID CURRENT_USER`)

- Whether its unqualified references to schema objects are resolved in the schema of the definer or invoker

If you do not specify the `AUTHID`, then the default behavior is `DEFINER`, that is, the stored procedure runs with the privileges of its definer. You can override the default behavior by specifying the `AUTHID` as `CURRENT_USER`. However, you cannot override the `loadjava` option `-definer` by specifying `CURRENT_USER`.

The `PARALLEL_ENABLE` option declares that a stored function can be used safely in the slave sessions of parallel DML evaluations. The state of a main session is never shared with slave sessions. Each slave session has its own state, which is initialized when the session begins. The function result should not depend on the state of session variables. Otherwise, results might vary across sessions.

The `DETERMINISTIC` option helps the optimizer avoid redundant function calls. If a stored function was called previously with the same arguments, then the optimizer can decide to use the previous result. The function result should not depend on the state of session variables or schema objects. Otherwise, results can vary across calls. Only `DETERMINISTIC` functions can be called from a function-based index or a materialized view that has query-rewrite enabled.

The string in the `NAME` clause uniquely identifies the Java method. The fully-qualified Java names and the call specification parameters, which are mapped by position, must correspond. However, this rule does not apply to the `main()` method. If the Java method does not take any arguments, then write an empty parameter list for it, but not for the function or procedure.

Write fully-qualified Java names using the dot notation. The following example shows that the fully-qualified names can be broken across lines at dot boundaries:

```
artificialIntelligence.neuralNetworks.patternClassification.  
RadarSignatureClassifier.computeRange()
```

7.3.1 Examples

This section provides the following examples:

- [Example 7-1](#)
- [Example 7-2](#)
- [Example 7-3](#)
- [Example 7-4](#)

Example 7-1 Publishing a Simple JDBC Stored Procedure

Assume that the executable for the following Java class has been loaded into the database:

```
import java.sql.*;  
import java.io.*;  
import oracle.jdbc.*;  
  
public class GenericDrop  
{  
    public static void dropIt(String object_type, String object_name)  
                                throws SQLException  
    {  
        // Connect to Oracle using JDBC driver  
        Connection conn = DriverManager.getConnection("jdbc:default:connection:");
```

```

// Build SQL statement
String sql = "DROP " + object_type + " " + object_name;
try
{
    Statement stmt = conn.createStatement();
    stmt.executeUpdate(sql);
    stmt.close();
}
catch (SQLException e)
{
    System.err.println(e.getMessage());
}
}
}

```

The `GenericDrop` class has one method, `dropIt()`, which drops any kind of schema object. For example, if you pass the `table` and `employees` arguments to `dropIt()`, then the method drops the database table `employees` from your schema.

The call specification for the `dropIt()` method is as follows:

```

CREATE OR REPLACE PROCEDURE drop_it (obj_type VARCHAR2, obj_name VARCHAR2)
AS LANGUAGE JAVA
NAME 'GenericDrop.dropIt(java.lang.String, java.lang.String)';

```

Note that you must fully qualify the reference to `String`. The `java.lang` package is automatically available to Java programs, but must be named explicitly in the call specifications.

Example 7-2 Publishing the `main()` Method

As a rule, Java names and call specification parameters must correspond. However, that rule does not apply to the `main()` method. Its `String[]` parameter can be mapped to multiple `CHAR` or `VARCHAR2` call specification parameters. Consider the `main()` method in the following class, which displays its arguments:

```

public class EchoInput
{
    public static void main (String[] args)
    {
        for (int i = 0; i < args.length; i++)
            System.out.println(args[i]);
    }
}

```

To publish `main()`, write the following call specification:

```

CREATE OR REPLACE PROCEDURE echo_input(s1 VARCHAR2, s2 VARCHAR2, s3 VARCHAR2)
AS LANGUAGE JAVA
NAME 'EchoInput.main(java.lang.String[])';

```

You cannot impose constraints, such as precision, size, and `NOT NULL`, on the call specification parameters. As a result, you cannot specify a maximum size for the `VARCHAR2` parameters. However, you must do so for `VARCHAR2` variables, as in:

```

DECLARE last_name VARCHAR2(20); -- size constraint required

```

Example 7-3 Publishing a Method That Returns an Integer Value

In the following example, the `rowCount()` method, which returns the number of rows in a given database table, is published:

```

import java.sql.*;
import java.io.*;
import oracle.jdbc.*;

public class RowCounter
{
    public static int rowCount (String tabName) throws SQLException
    {
        Connection conn = DriverManager.getConnection("jdbc:default:connection:");
        String sql = "SELECT COUNT(*) FROM " + tabName;
        int rows = 0;
        try
        {
            Statement stmt = conn.createStatement();
            ResultSet rset = stmt.executeQuery(sql);
            while (rset.next())
            {
                rows = rset.getInt(1);
            }
            rset.close();
            stmt.close();
        }
        catch (SQLException e)
        {
            System.err.println(e.getMessage());
        }
        return rows;
    }
}

```

NUMBER subtypes, such as INTEGER, REAL, and POSITIVE, are not allowed in a call specification. As a result, in the following call specification, the return type is NUMBER and not INTEGER:

```

CREATE FUNCTION row_count (tab_name VARCHAR2) RETURN NUMBER
AS LANGUAGE JAVA
NAME 'RowCounter.rowCount(java.lang.String) return int';

```

Example 7-4 Publishing a Method That Switches the Values of Its Arguments

Consider the `swap()` method in the following `Swapper` class, which switches the values of its arguments:

```

public class Swapper
{
    public static void swap (int[] x, int[] y)
    {
        int hold = x[0];
        x[0] = y[0];
        y[0] = hold;
    }
}

```

The call specification publishes the `swap()` method as a call specification, `swap()`. The call specification declares IN OUT formal parameters, because values must be passed in and out. All call specification OUT and IN OUT parameters must map to Java array parameters.

```

CREATE PROCEDURE swap (x IN OUT NUMBER, y IN OUT NUMBER)
AS LANGUAGE JAVA
NAME 'Swapper.swap(int[], int[])';

```

 **Note:**

A Java method and its call specification can have the same name.

7.4 Writing Packaged Call Specifications

A PL/SQL package is a schema object that groups logically related types, items, and subprograms. Usually, packages have two parts, a specification and a body. The specification is the interface to your applications and declares the types, constants, variables, exceptions, cursors, and subprograms available for use. The body defines the cursors and subprograms.

In SQL*Plus, you can define PL/SQL packages interactively, using the following syntax:

```
CREATE [OR REPLACE] PACKAGE package_name
  [AUTHID {CURRENT_USER | DEFINER}] {IS | AS}
  [type_definition [type_definition] ...]
  [cursor_spec [cursor_spec] ...]
  [item_declaration [item_declaration] ...]
  [{subprogram_spec | call_spec} [{subprogram_spec | call_spec}]...]
END [package_name];

[CREATE [OR REPLACE] PACKAGE BODY package_name {IS | AS}
  [type_definition [type_definition] ...]
  [cursor_body [cursor_body] ...]
  [item_declaration [item_declaration] ...]
  [{subprogram_spec | call_spec} [{subprogram_spec | call_spec}]...]
[BEGIN
  sequence_of_statements]
END [package_name];]
```

The specification holds public declarations, which are visible to your application. The body contains implementation details and private declarations, which are hidden from your application. Following the declarative part of the package is the body, which is the optional initialization part. It holds statements that initialize package variables. It is run only once, the first time you reference the package.

A call specification declared in a package specification cannot have the same signature, that is, the name and parameter list, as a subprogram in the package body. If you declare all the subprograms in a package specification as call specifications, then the package body is not required, unless you want to define a cursor or use the initialization part.

The AUTHID clause determines whether all the packaged subprograms run with the privileges of their definer (AUTHID DEFINER), which is the default, or invoker (AUTHID CURRENT_USER). It also determines whether unqualified references to schema objects are resolved in the schema of the definer or invoker.

[Example 7-5](#) provides an example of packaged call specification.

Example 7-5 Packaged Call Specification

Consider a Java class, `DeptManager`, which consists of methods for adding a new department, dropping a department, and changing the location of a department. Note that the `addDept()` method uses a database sequence to get the next department

number. The three methods are logically related, and therefore, you may want to group their call specifications in a PL/SQL package.

```
import java.sql.*;
import java.io.*;
import oracle.jdbc.*;

public class DeptManager
{
    public static void addDept (String deptName, String deptLoc) throws SQLException
    {
        Connection conn = DriverManager.getConnection("jdbc:default:connection:");
        String sql = "SELECT deptnos.NEXTVAL FROM dual";
        String sql2 = "INSERT INTO dept VALUES (?, ?, ?)";
        int deptID = 0;
        try
        {
            PreparedStatement pstmt = conn.prepareStatement(sql);
            ResultSet rset = pstmt.executeQuery();
            while (rset.next())
            {
                deptID = rset.getInt(1);
            }
            pstmt = conn.prepareStatement(sql2);
            pstmt.setInt(1, deptID);
            pstmt.setString(2, deptName);
            pstmt.setString(3, deptLoc);
            pstmt.executeUpdate();
            rset.close();
            pstmt.close();
        }
        catch (SQLException e)
        {
            System.err.println(e.getMessage());
        }
    }

    public static void dropDept (int deptID) throws SQLException
    {
        Connection conn = DriverManager.getConnection("jdbc:default:connection:");
        String sql = "DELETE FROM dept WHERE deptno = ?";
        try
        {
            PreparedStatement pstmt = conn.prepareStatement(sql);
            pstmt.setInt(1, deptID);
            pstmt.executeUpdate();
            pstmt.close();
        }
        catch (SQLException e)
        {
            System.err.println(e.getMessage());
        }
    }

    public static void changeLoc (int deptID, String newLoc) throws SQLException
    {
        Connection conn = DriverManager.getConnection("jdbc:default:connection:");
        String sql = "UPDATE dept SET loc = ? WHERE deptno = ?";
        try
        {
            PreparedStatement pstmt = conn.prepareStatement(sql);
```

```

        pstmt.setString(1, newLoc);
        pstmt.setInt(2, deptID);
        pstmt.executeUpdate();
        pstmt.close();
    }
    catch (SQLException e)
    {
        System.err.println(e.getMessage());
    }
}
}

```

Suppose you want to package the methods `addDept()`, `dropDept()`, and `changeLoc()`. First, you must create the package specification, as follows:

```

CREATE OR REPLACE PACKAGE dept_mgmt AS
PROCEDURE add_dept (dept_name VARCHAR2, dept_loc VARCHAR2);
PROCEDURE drop_dept (dept_id NUMBER);
PROCEDURE change_loc (dept_id NUMBER, new_loc VARCHAR2);
END dept_mgmt;

```

Then, you must create the package body by writing the call specifications for the Java methods, as follows:

```

CREATE OR REPLACE PACKAGE BODY dept_mgmt AS
PROCEDURE add_dept (dept_name VARCHAR2, dept_loc VARCHAR2)
AS LANGUAGE JAVA
NAME 'DeptManager.addDept(java.lang.String, java.lang.String)';

PROCEDURE drop_dept (dept_id NUMBER)
AS LANGUAGE JAVA
NAME 'DeptManager.dropDept(int)';

PROCEDURE change_loc (dept_id NUMBER, new_loc VARCHAR2)
AS LANGUAGE JAVA
NAME 'DeptManager.changeLoc(int, java.lang.String)';
END dept_mgmt;

```

To reference the stored procedures in the `dept_mgmt` package, use the dot notation, as follows:

```

CALL dept_mgmt.add_dept('PUBLICITY', 'DALLAS');

```

7.5 Writing Object Type Call Specifications

In SQL, object-oriented programming is based on object types, which are user-defined composite data types that encapsulate a data structure along with the functions and procedures required to manipulate the data. The variables that form the data structure are known as attributes. The functions and procedures that characterize the behavior of the object type are known as methods, which can be written in Java.

As with a package, an object type has two parts: a specification and a body. The specification is the interface to your applications and declares a data structure, which is a set of attributes, along with the operations or methods required to manipulate the data. The body implements the specification by defining PL/SQL subprogram bodies or call specifications.

If the specification declares only attributes or call specifications, then the body is not required. If you implement all your methods in Java, then you can place their call specifications in the specification part of the object type and omit the body part.

In SQL*Plus, you can define SQL object types interactively, using the following syntax:

```
CREATE [OR REPLACE] TYPE type_name
  [AUTHID {CURRENT_USER | DEFINER}] {IS | AS} OBJECT (
  attribute_name data_type[, attribute_name data_type]...
  [{MAP | ORDER} MEMBER {function_spec | call_spec},]
  [{MEMBER | STATIC} {subprogram_spec | call_spec}
  [, {MEMBER | STATIC} {subprogram_spec | call_spec}]...]
);

[CREATE [OR REPLACE] TYPE BODY type_name {IS | AS}
  { {MAP | ORDER} MEMBER function_body;
  | {MEMBER | STATIC} {subprogram_body | call_spec};}
  [{MEMBER | STATIC} {subprogram_body | call_spec};]...
END;]
```

The `AUTHID` clause determines whether all member methods of the type run with the privileges of their definer (`AUTHID DEFINER`), which is the default, or invoker (`AUTHID CURRENT_USER`). It also determines whether unqualified references to schema objects are resolved in the schema of the definer or invoker.

This section covers the following topics:

- [About Attributes](#)
- [Declaring Methods](#)

7.5.1 About Attributes

In an object type specification, all attributes must be declared before any methods are. In addition, you must declare at least one attribute. The maximum number of attributes that can be declared is 1000. Methods are optional.

As with a Java variable, you declare an attribute with a name and data type. The name must be unique within the object type, but can be reused in other object types. The data type can be any SQL type, except `LONG`, `LONG RAW`, `NCHAR`, `NVARCHAR2`, `NCLOB`, `ROWID`, and `UROWID`.

You cannot initialize an attribute in its declaration using the assignment operator or `DEFAULT` clause. Furthermore, you cannot impose the `NOT NULL` constraint on an attribute. However, objects can be stored in database tables on which you can impose constraints.

7.5.2 Declaring Methods

After declaring attributes, you can declare methods. `MEMBER` methods accept a built-in parameter known as `SELF`, which is an instance of the object type. Whether declared implicitly or explicitly, it is always the first parameter passed to a `MEMBER` method. In the method body, `SELF` denotes the object whose method was called. `MEMBER` methods are called on instances, as follows:

```
instance_expression.method()
```

`STATIC` methods, which cannot accept or reference `SELF`, are invoked on the object type and not its instances, as follows:

```
object_type_name.method()
```

If you want to call a Java method that is not `static`, then you must specify the keyword `MEMBER` in its call specification. Similarly, if you want to call a `static` Java method, then you must specify the keyword `STATIC` in its call specification.

This section contains the following topics:

- [Map and Order Methods](#)
- [Constructor Methods](#)
- [Examples](#)

7.5.2.1 Map and Order Methods

The values of a SQL scalar data type, such as `CHAR`, have a predefined order and, therefore, can be compared with other values. However, instances of an object type have no predefined order. To put them in order, SQL calls a user-defined `map` method.

SQL uses the ordering to evaluate boolean expressions, such as $x > y$, and to make comparisons implied by the `DISTINCT`, `GROUP BY`, and `ORDER BY` clauses. A `map` method returns the relative position of an object in the ordering of all such objects. An object type can contain only one `map` method, which must be a function without any parameters and with one of the following return types: `DATE`, `NUMBER`, or `VARCHAR2`.

Alternatively, you can supply SQL with an `order` method, which compares two objects. An `order` method takes only two parameters: the built-in parameter, `SELF`, and another object of the same type. If `o1` and `o2` are objects, then a comparison, such as $o1 > o2$, calls the `order` method automatically. The method returns a negative number, zero, or a positive number signifying that `SELF` is less than, equal to, or greater than the other parameter, respectively. An object type can contain only one `order` method, which must be a function that returns a numeric result.

You can declare a `map` method or an `order` method, but not both. If you declare either of these methods, then you can compare objects in SQL and PL/SQL. However, if you do not declare both methods, then you can compare objects only in SQL and solely for equality or inequality.

 **Note:**

Two objects of the same type are equal if the values of their corresponding attributes are equal.

7.5.2.2 Constructor Methods

Every object type has a constructor, which is a system-defined function with the same name as the object type. The constructor initializes and returns an instance of that object type.

Oracle Database generates a default constructor for every object type. The formal parameters of the constructor match the attributes of the object type. That is, the

parameters and attributes are declared in the same order and have the same names and data types. SQL never calls a constructor implicitly. As a result, you must call it explicitly. Constructor calls are allowed wherever function calls are allowed.

**Note:**

To invoke a Java constructor from SQL, you must wrap calls to it in a `static` method and declare the corresponding call specification as a `STATIC` member of the object type.

7.5.2.3 Examples

In this section, each example builds on the previous one. To begin, you create two SQL object types to represent departments and employees. First, you write the specification for the object type `Department`. The body is not required, because the specification declares only attributes. The specification is as follows:

```
CREATE TYPE Department AS OBJECT (  
  deptno NUMBER(2),  
  dname VARCHAR2(14),  
  loc VARCHAR2(13)  
);
```

Then, you create the object type `Employee`. The `deptno` attribute stores a handle, called a `REF`, to objects of the type `Department`. A `REF` indicates the location of an object in an object table, which is a database table that stores instances of an object type. The `REF` does not point to a specific instance copy in memory. To declare a `REF`, you specify the data type `REF` and the object type that `REF` targets. The `Employee` type is created as follows:

```
CREATE TYPE Employee AS OBJECT (  
  empno NUMBER(4),  
  ename VARCHAR2(10),  
  job VARCHAR2(9),  
  mgr NUMBER(4),  
  hiredate DATE,  
  sal NUMBER(7,2),  
  comm NUMBER(7,2),  
  deptno REF Department  
);
```

Next, you create the SQL object tables to hold objects of type `Department` and `Employee`. Create the `depts` object table, which will hold objects of the `Department` type. Populate the object table by selecting data from the `dept` relational table and passing it to a constructor, which is a system-defined function with the same name as the object type. Use the constructor to initialize and return an instance of that object type. The `depts` table is created as follows:

```
CREATE TABLE depts OF Department AS  
SELECT Department(deptno, dname, loc) FROM dept;
```

Create the `emps` object table, which will hold objects of type `Employee`. The last column in the `emps` object table, which corresponds to the last attribute of the `Employee` object type, holds references to objects of type `Department`. To fetch the references into this

column, use the operator `REF`, which takes a table alias associated with a row in an object table as its argument. The `emps` table is created as follows:

```
CREATE TABLE emps OF Employee AS
SELECT Employee(e.employee_id, e.first_name, e.job_id, e.manager_id, e.hire_date,
e.salary, e.commission_pct,
(SELECT REF(d) FROM departments d WHERE d.department_id = e.department_id))
FROM employees e;
```

Selecting a `REF` returns a handle to an object. It does not materialize the object itself. To do that, you can use methods in the `oracle.sql.REF` class, which supports Oracle object references. This class, which is a subclass of `oracle.sql.Datum`, extends the standard JDBC interface, `oracle.jdbc2.Ref`.

Using Class `oracle.sql.STRUCT`

To continue, you write a Java stored procedure. The `Paymaster` class has one method, which computes an employee's wages. The `getAttributes()` method defined in the `oracle.sql.STRUCT` class uses the default JDBC mappings for the attribute types. For example, `NUMBER` maps to `BigDecimal`. The `Paymaster` class is created as follows:

```
import java.sql.*;
import java.io.*;
import oracle.sql.*;
import oracle.jdbc.*;
import oracle.oracore.*;
import oracle.jdbc2.*;
import java.math.*;

public class Paymaster
{
    public static BigDecimal wages(STRUCT e) throws java.sql.SQLException
    {
        // Get the attributes of the Employee object.
        Object[] attribs = e.getAttributes();
        // Must use numeric indexes into the array of attributes.
        BigDecimal sal = (BigDecimal)(attribs[5]); // [5] = sal
        BigDecimal comm = (BigDecimal)(attribs[6]); // [6] = comm
        BigDecimal pay = sal;
        if (comm != null)
            pay = pay.add(comm);
        return pay;
    }
}
```

Because the `wages()` method returns a value, you write a function call specification for it, as follows:

```
CREATE OR REPLACE FUNCTION wages (e Employee) RETURN NUMBER AS
LANGUAGE JAVA
NAME 'Paymaster.wages(oracle.sql.STRUCT) return BigDecimal';
```

This is a top-level call specification, because it is not defined inside a package or object type.

Implementing the `SQLData` Interface

To make access to object attributes more natural, create a Java class that implements the `SQLData` interface. To do so, you must provide the `readSQL()` and `writeSQL()` methods as defined by the `SQLData` interface. The JDBC driver calls the `readSQL()`

method to read a stream of database values and populate an instance of your Java class. In the following example, you revise `Paymaster` by adding a second method, `raiseSal()`:

```
import java.sql.*;
import java.io.*;
import oracle.sql.*;
import oracle.jdbc.*;
import oracle.oracore.*;
import oracle.jdbc2.*;
import java.math.*;

public class Paymaster implements SQLData
{
    // Implement the attributes and operations for this type.
    private BigDecimal empno;
    private String ename;
    private String job;
    private BigDecimal mgr;
    private Date hiredate;
    private BigDecimal sal;
    private BigDecimal comm;
    private Ref dept;

    public static BigDecimal wages(Paymaster e)
    {
        BigDecimal pay = e.sal;
        if (e.comm != null)
            pay = pay.add(e.comm);
        return pay;
    }

    public static void raiseSal(Paymaster[] e, BigDecimal amount)
    {
        e[0].sal = // IN OUT passes [0]
        e[0].sal.add(amount); // increase salary by given amount
    }

    // Implement SQLData interface.

    private String sql_type;

    public String getSQLTypeName() throws SQLException
    {
        return sql_type;
    }

    public void readSQL(SQLInput stream, String typeName) throws SQLException
    {
        sql_type = typeName;
        empno = stream.readBigDecimal();
        ename = stream.readString();
        job = stream.readString();
        mgr = stream.readBigDecimal();
        hiredate = stream.readDate();
        sal = stream.readBigDecimal();
        comm = stream.readBigDecimal();
        dept = stream.readRef();
    }

    public void writeSQL(SQLOutput stream) throws SQLException
```

```

    {
      stream.writeBigDecimal(empno);
      stream.writeString(ename);
      stream.writeString(job);
      stream.writeBigDecimal(mgr);
      stream.writeDate(hiredate);
      stream.writeBigDecimal(sal);
      stream.writeBigDecimal(comm);
      stream.writeRef(dept);
    }
  }
}

```

You must revise the call specification for `wages()`, as follows, because its parameter has changed from `oracle.sql.STRUCT` to `Paymaster`:

```

CREATE OR REPLACE FUNCTION wages (e Employee) RETURN NUMBER AS
LANGUAGE JAVA
NAME 'Paymaster.wages(Paymaster) return BigDecimal';

```

Because the new method, `raiseSal()`, is void, write a procedure call specification for it, as follows:

```

CREATE OR REPLACE PROCEDURE raise_sal (e IN OUT Employee, r NUMBER)
AS LANGUAGE JAVA
NAME 'Paymaster.raiseSal(Paymaster[], java.math.BigDecimal)';

```

Again, this is a top-level call specification.

Implementing Object Type Methods

Assume you decide to drop the top-level call specifications `wages` and `raise_sal` and redeclare them as methods of the object type `Employee`. In an object type specification, all methods must be declared after the attributes. The body of the object type is not required, because the specification declares only attributes and call specifications. The `Employee` object type can be re-created as follows:

```

CREATE TYPE Employee AS OBJECT (
  empno NUMBER(4),
  ename VARCHAR2(10),
  job VARCHAR2(9),
  mgr NUMBER(4),
  hiredate DATE,
  sal NUMBER(7,2),
  comm NUMBER(7,2),
  deptno REF Department
  MEMBER FUNCTION wages RETURN NUMBER
  AS LANGUAGE JAVA
  NAME 'Paymaster.wages() return java.math.BigDecimal',
  MEMBER PROCEDURE raise_sal (r NUMBER)
  AS LANGUAGE JAVA
  NAME 'Paymaster.raiseSal(java.math.BigDecimal)'
);

```

Then, you revise `Paymaster` accordingly. You need not pass an array to `raiseSal()`, because the SQL parameter `SELF` corresponds directly to the Java parameter `this`, even when `SELF` is declared as `IN OUT`, which is the default for procedures.

```

import java.sql.*;
import java.io.*;
import oracle.sql.*;

```

```
import oracle.jdbc.*;
import oracle.oracore.*;
import oracle.jdbc2.*;
import java.math.*;

public class Paymaster implements SQLData
{
    // Implement the attributes and operations for this type.
    private BigDecimal empno;
    private String ename;
    private String job;
    private BigDecimal mgr;
    private Date hiredate;
    private BigDecimal sal;
    private BigDecimal comm;
    private Ref dept;

    public BigDecimal wages()
    {
        BigDecimal pay = sal;
        if (comm != null)
            pay = pay.add(comm);
        return pay;
    }

    public void raiseSal(BigDecimal amount)
    {
        // For SELF/this, even when IN OUT, no array is needed.
        sal = sal.add(amount);
    }

    // Implement SQLData interface.

    String sql_type;

    public String getSQLTypeName() throws SQLException
    {
        return sql_type;
    }

    public void readSQL(SQLInput stream, String typeName) throws SQLException
    {
        sql_type = typeName;
        empno = stream.readBigDecimal();
        ename = stream.readString();
        job = stream.readString();
        mgr = stream.readBigDecimal();
        hiredate = stream.readDate();
        sal = stream.readBigDecimal();
        comm = stream.readBigDecimal();
        dept = stream.readRef();
    }

    public void writeSQL(SQLOutput stream) throws SQLException
    {
        stream.writeBigDecimal(empno);
        stream.writeString(ename);
        stream.writeString(job);
        stream.writeBigDecimal(mgr);
        stream.writeDate(hiredate);
        stream.writeBigDecimal(sal);
    }
}
```

```
        stream.writeBigDecimal(comm);  
        stream.writeRef(dept);  
    }  
}
```

8

Calling Stored Procedures

After you load and publish a Java stored procedure, you can call it. This chapter describes the procedure for calling Java stored procedures in various contexts. It also describes how Oracle JVM handles SQL exceptions.

This chapter contains the following sections:

- [Calling Java from the Top Level](#)
- [Calling Java from Database Triggers](#)
- [Calling Java from SQL DML](#)
- [Calling Java from PL/SQL](#)
- [Calling PL/SQL from Java](#)
- [How Oracle JVM Handles Exceptions](#)

8.1 Calling Java from the Top Level

The SQL `CALL` statement lets you call Java methods, which are published at the top level, in PL/SQL packages, or in SQL object types. In SQL*Plus, you can run the `CALL` statement interactively using the following syntax:

```
CALL [schema_name.][{package_name | object_type_name}][@dblink_name]
  { procedure_name ([param[, param]...])
    | function_name ([param[, param]...]) INTO :host_variable};
```

where `param` is represented by the following syntax:

```
{literal | :host_variable}
```

Host variables are variables that are declared in a host environment. They must be prefixed with a colon. The following examples show that a host variable cannot appear twice in the same `CALL` statement and that a subprogram without parameters must be called with an empty parameter list:

```
CALL swap(:x, :x); -- illegal, duplicate host variables
CALL balance() INTO :current_balance; -- () required
```

This section covers the following topics:

- [Redirecting the Output](#)
- [Examples of Calling Java Stored Procedures From the Top Level](#)

8.1.1 Redirecting the Output

On the server, the default output device is a trace file and not the user screen. As a result, `System.out` and `System.err` print output to the current trace files. To redirect output to the SQL*Plus text buffer, you must call the `set_output()` procedure in the `DBMS_JAVA` package, as follows:

```
SQL> SET SERVEROUTPUT ON
SQL> CALL dbms_java.set_output(2000);
```

The minimum buffer size is 2,000 bytes, which is also the default size, and the maximum buffer size is 1,000,000 bytes. In the following example, the buffer size is increased to 5,000 bytes:

```
SQL> SET SERVEROUTPUT ON SIZE 5000
SQL> CALL dbms_java.set_output(5000);
```

The output is displayed when the stored procedure exits.

8.1.2 Examples of Calling Java Stored Procedures From the Top Level

This section provides the following examples

- [Example 8-1](#)
- [Example 8-2](#)

Example 8-1 A Simple JDBC Stored Procedure

In the following example, the `main()` method accepts the name of a database table, such as `employees`, and an optional `WHERE` clause specifying a condition, such as `salary > 1500`. If you omit the condition, then the method deletes all rows from the table, else it deletes only those rows that meet the condition.

```
import java.sql.*;
import oracle.jdbc.*;

public class Deleter
{
    public static void main (String[] args) throws SQLException
    {
        Connection conn = DriverManager.getConnection("jdbc:default:connection:");
        String sql = "DELETE FROM " + args[0];
        if (args.length > 1)
            sql += " WHERE " + args[1];
        try
        {
            Statement stmt = conn.createStatement();
            stmt.executeUpdate(sql);
            stmt.close();
        }
        catch (SQLException e)
        {
            System.err.println(e.getMessage());
        }
    }
}
```

The `main()` method can take either one or two arguments. Usually, the `DEFAULT` clause is used to vary the number of arguments passed to a PL/SQL subprogram. However, this clause is not allowed in a call specification. As a result, you must overload two packaged procedures, as follows:

```
CREATE OR REPLACE PACKAGE pkg AS
PROCEDURE delete_rows (table_name VARCHAR2);
PROCEDURE delete_rows (table_name VARCHAR2, condition VARCHAR2);
END;
```

```
CREATE OR REPLACE PACKAGE BODY pkg AS
PROCEDURE delete_rows (table_name VARCHAR2)
AS LANGUAGE JAVA
NAME 'Deleter.main(java.lang.String[])';

PROCEDURE delete_rows (table_name VARCHAR2, condition VARCHAR2)
AS LANGUAGE JAVA
NAME 'Deleter.main(java.lang.String[])';
END;
```

Now, you can call the `delete_rows` procedure, as follows:

```
SQL> CALL pkg.delete_rows('employees', 'salary > 1500');
```

Call completed.

```
SQL> SELECT first_name, salary FROM employees;
```

```
FIRST_NAME  SALARY
-----
SMITH        800
WARD         1250
MARTIN       1250
TURNER       1500
ADAMS        1100
JAMES        950
MILLER       1300
```

7 rows selected.

 **Note:**

You cannot overload top-level procedures.

Example 8-2 Fibonacci Sequence

Assume that the executable for the following Java class is stored in Oracle Database:

```
public class Fibonacci
{
    public static int fib (int n)
    {
        if (n == 1 || n == 2)
            return 1;
        else
            return fib(n - 1) + fib(n - 2);
    }
}
```

The `Fibonacci` class has a method, `fib()`, which returns the n th Fibonacci number. The Fibonacci sequence, 1, 1, 2, 3, 5, 8, 13, 21, . . ., is recursive. Each term in the sequence, after the second term, is the sum of the two terms that immediately precede it. Because `fib()` returns a value, you must publish it as a function, as follows:

```
CREATE OR REPLACE FUNCTION fib (n NUMBER) RETURN NUMBER
AS LANGUAGE JAVA
NAME 'Fibonacci.fib(int) return int';
```

Next, you declare two SQL*Plus host variables and initialize the first one:

```
SQL> VARIABLE n NUMBER
SQL> VARIABLE f NUMBER
SQL> EXECUTE :n := 7;
```

PL/SQL procedure successfully completed.

Now, you can call the `fib()` function. In a `CALL` statement, host variables must be prefixed with a colon. The function can be called, as follows:

```
SQL> CALL fib(:n) INTO :f;
```

Call completed.

```
SQL> PRINT f
```

```
F
-----
13
```

8.2 Calling Java from Database Triggers

A database trigger is a stored program that is associated with a specific table or view. Oracle Database runs the trigger automatically whenever a data manipulation language (DML) operation affects the table or view.

When a triggering event occurs, the trigger runs and either a PL/SQL block or a `CALL` statement performs the action. A statement trigger runs once, before or after the triggering event. A row trigger runs once for each row affected by the triggering event.

In a database trigger, you can reference the new and old values of changing rows by using the correlation names `new` and `old`. In the trigger-action block or `CALL` statement, column names must be prefixed with `:new` or `:old`.

The following are examples of calling Java stored procedures from a database trigger:

- [Example 8-3](#)
- [Example 8-4](#)

Example 8-3 Calling Java Stored Procedure from Database Trigger - I

Assume you want to create a database trigger that uses the following Java class to log out-of-range salary increases:

```
import java.sql.*;
import java.io.*;
import oracle.jdbc.*;

public class DBTrigger
{
    public static void logSal (int empID, float oldSal, float newSal)
                                throws SQLException
    {
        Connection conn = DriverManager.getConnection("jdbc:default:connection:");
        String sql = "INSERT INTO sal_audit VALUES (?, ?, ?)";
        try
        {
            PreparedStatement pstmt = conn.prepareStatement(sql);
            pstmt.setInt(1, empID);
```

```

        pstmt.setFloat(2, oldSal);
        pstmt.setFloat(3, newSal);
        pstmt.executeUpdate();
        pstmt.close();
    }
    catch (SQLException e)
    {
        System.err.println(e.getMessage());
    }
}
}

```

The `DBTrigger` class has one method, `logSal()`, which inserts a row into the `sal_audit` table. Because `logSal()` is a void method, you must publish it as a procedure:

```

CREATE OR REPLACE PROCEDURE log_sal (
    emp_id NUMBER,
    old_sal NUMBER,
    new_sal NUMBER
)
AS LANGUAGE JAVA
NAME 'DBTrigger.logSal(int, float, float)';

```

Next, create the `sal_audit` table, as follows:

```

CREATE TABLE sal_audit (
    empno NUMBER,
    oldsal NUMBER,
    newsal NUMBER
);

```

Finally, create the database trigger, which fires when a salary increase exceeds 20 percent:

```

CREATE OR REPLACE TRIGGER sal_trig
AFTER UPDATE OF salary ON employees
FOR EACH ROW
WHEN (new.salary > 1.2 * old.salary)
CALL log_sal(:new.employee_id, :old.salary, :new.salary);

```

When you run the following `UPDATE` statement, it updates all rows in the `employees` table:

```
SQL> UPDATE employee SET salary = salary + 300;
```

For each row that meets the condition set in the `WHEN` clause of the trigger, the trigger runs and the Java method inserts a row into the `sal_audit` table.

```
SQL> SELECT * FROM sal_audit;
```

EMPNO	OLDSAL	NEWSAL
7369	800	1100
7521	1250	1550
7654	1250	1550
7876	1100	1400
7900	950	1250
7934	1300	1600

```
6 rows selected.
```

Example 8-4 Calling Java Stored Procedure from Database Trigger - II

Assume you want to create a trigger that inserts rows into a database view, which is defined as follows:

```
CREATE VIEW emps AS
SELECT empno, ename, 'Sales' AS dname FROM sales
UNION ALL
SELECT empno, ename, 'Marketing' AS dname FROM mktg;
```

The sales and mktg database tables are defined as:

```
CREATE TABLE sales (empno NUMBER(4), ename VARCHAR2(10));
CREATE TABLE mktg (empno NUMBER(4), ename VARCHAR2(10));
```

You must write an `INSTEAD OF` trigger because rows cannot be inserted into a view that uses set operators, such as `UNION ALL`. Instead, the trigger will insert rows into the base tables.

First, add the following Java method to the `DBTrigger` class, which is defined in [Example 8-3](#):

```
public static void addEmp (int empNo, String empName, String deptName)
                        throws SQLException
{
    Connection conn = DriverManager.getConnection("jdbc:default:connection:");
    String tabName = (deptName.equals("Sales") ? "sales" : "mktg");
    String sql = "INSERT INTO " + tabName + " VALUES (?, ?)";
    try
    {
        PreparedStatement pstmt = conn.prepareStatement(sql);
        pstmt.setInt(1, empNo);
        pstmt.setString(2, empName);
        pstmt.executeUpdate();
        pstmt.close();
    }
    catch (SQLException e)
    {
        System.err.println(e.getMessage());
    }
}
```

The `addEmp()` method inserts a row into the sales or mktg table depending on the value of the `deptName` parameter. Write the call specification for this method, as follows:

```
CREATE OR REPLACE PROCEDURE add_emp (
    emp_no NUMBER,
    emp_name VARCHAR2,
    dept_name VARCHAR2
)
AS LANGUAGE JAVA
NAME 'DBTrigger.addEmp(int, java.lang.String, java.lang.String)';
```

Next, create the `INSTEAD OF` trigger, as follows:

```
CREATE OR REPLACE TRIGGER emps_trig
INSTEAD OF INSERT ON emps
FOR EACH ROW
CALL add_emp(:new.empno, :new.ename, :new.dname);
```

When you run each of the following `INSERT` statements, the trigger runs and the Java method inserts a row into the appropriate base table:

```
SQL> INSERT INTO emps VALUES (8001, 'Chand', 'Sales');
SQL> INSERT INTO emps VALUES (8002, 'Van Horn', 'Sales');
SQL> INSERT INTO emps VALUES (8003, 'Waters', 'Sales');
SQL> INSERT INTO emps VALUES (8004, 'Bellock', 'Marketing');
SQL> INSERT INTO emps VALUES (8005, 'Perez', 'Marketing');
SQL> INSERT INTO emps VALUES (8006, 'Foucault', 'Marketing');
```

```
SQL> SELECT * FROM sales;
```

EMPNO	ENAME
8001	Chand
8002	Van Horn
8003	Waters

```
SQL> SELECT * FROM mktg;
```

EMPNO	ENAME
8004	Bellock
8005	Perez
8006	Foucault

```
SQL> SELECT * FROM emps;
```

EMPNO	ENAME	DNAME
8001	Chand	Sales
8002	Van Horn	Sales
8003	Waters	Sales
8004	Bellock	Marketing
8005	Perez	Marketing
8006	Foucault	Marketing

8.3 Calling Java from SQL DML

If you publish Java methods as functions, then you can call them from SQL `SELECT`, `INSERT`, `UPDATE`, `DELETE`, `CALL`, `EXPLAIN PLAN`, `LOCK TABLE`, and `MERGE` statements. For example, assume that the executable for the following Java class is stored in Oracle Database:

```
public class Formatter
{
    public static String formatEmp (String empName, String jobTitle)
    {
        empName = empName.substring(0,1).toUpperCase() +
                    empName.substring(1).toLowerCase();
        jobTitle = jobTitle.toLowerCase();
        if (jobTitle.equals("analyst"))
            return (new String(empName + " is an exempt analyst"));
        else
            return (new String(empName + " is a non-exempt " + jobTitle));
    }
}
```

The `Formatter` class has the `formatEmp()` method, which returns a formatted string containing a staffer's name and job status. Write the call specification for this method, as follows:

```
CREATE OR REPLACE FUNCTION format_emp (ename VARCHAR2, job VARCHAR2)
RETURN VARCHAR2
AS LANGUAGE JAVA
NAME 'Formatter.formatEmp (java.lang.String, java.lang.String)
return java.lang.String';
```

Now, call the `format_emp` function to format a list of employees:

```
SQL> SELECT format_emp(first_name, job_id) AS "Employees" FROM employees
  2  WHERE job_id NOT IN ('AC_MGR', 'AD_PRES') ORDER BY first_name;
```

```
Employees
-----
Adams is a non-exempt clerk
Allen is a non-exempt salesman
Ford is an exempt analyst
James is a non-exempt clerk
Martin is a non-exempt salesman
Miller is a non-exempt clerk
Scott is an exempt analyst
Smith is a non-exempt clerk
Turner is a non-exempt salesman
Ward is a non-exempt salesman
```

Restrictions

A Java method must adhere to the following rules, which are meant to control side effects:

- When you call a method from a `SELECT` statement or parallel `INSERT`, `UPDATE`, or `DELETE` statements, the method cannot modify any database tables.
- When you call a method from an `INSERT`, `UPDATE`, or `DELETE` statement, the method cannot query or modify any database tables modified by that statement.
- When you call a method from a `SELECT`, `INSERT`, `UPDATE`, or `DELETE` statement, the method cannot run SQL transaction control statements, such as `COMMIT`, session control statements, such as `SET ROLE`, or system control statements, such as `ALTER SYSTEM`. In addition, the method cannot run data definition language (DDL) statements, such as `CREATE`, because they are followed by an automatic commit.

If any SQL statement inside the method violates any of the preceding rules, then you get an error at run time.

8.4 Calling Java from PL/SQL

You can call Java stored procedures from any PL/SQL block, subprogram, or package. For example, assume that the executable for the following Java class is stored in Oracle Database:

```
import java.sql.*;
import oracle.jdbc.*;

public class Adjuster
{
    public static void raiseSalary (int empNo, float percent) throws SQLException
```

```

{
  Connection conn = DriverManager.getConnection("jdbc:default:connection:");
  String sql = "UPDATE employees SET salary = salary * ? WHERE employee_id = ?";
  try
  {
    PreparedStatement pstmt = conn.prepareStatement(sql);
    pstmt.setFloat(1, (1 + percent / 100));
    pstmt.setInt(2, empNo);
    pstmt.executeUpdate();
    pstmt.close();
  }
  catch (SQLException e)
  {
    System.err.println(e.getMessage());
  }
}
}

```

The `Adjuster` class has one method, which raises the salary of an employee by a given percentage. Because `raiseSalary()` is a void method, you must publish it as a procedure, as follows:

```

CREATE OR REPLACE PROCEDURE raise_salary (empno NUMBER, pct NUMBER)
AS LANGUAGE JAVA
NAME 'Adjuster.raiseSalary(int, float)';

```

In the following example, you call the `raise_salary` procedure from an anonymous PL/SQL block:

```

DECLARE
emp_id NUMBER;
percent NUMBER;
BEGIN
-- get values for emp_id and percent
raise_salary(emp_id, percent);
...
END;

```

In the following example, you call the `row_count` function, which defined in [Example 7-3](#), from a standalone PL/SQL stored procedure:

```

CREATE PROCEDURE calc_bonus (emp_id NUMBER, bonus OUT NUMBER) AS
emp_count NUMBER;
...
BEGIN
emp_count := row_count('employees');
...
END;

```

In the following example, you call the `raise_sal` method of the `Employee` object type, which is defined in "[Implementing Object Type Methods](#)", from an anonymous PL/SQL block:

```

DECLARE
emp_id NUMBER(4);
v emp_type;
BEGIN
-- assign a value to emp_id
SELECT VALUE(e) INTO v FROM emps e WHERE empno = emp_id;
v.raise_sal(500);
UPDATE emps e SET e = v WHERE empno = emp_id;

```



```
...  
END;
```

8.5 Calling PL/SQL from Java

Java Database Connectivity (JDBC) enable you to call PL/SQL stored functions and procedures. For example, you want to call the following stored function, which returns the balance of a specified bank account:

```
FUNCTION balance (acct_id NUMBER) RETURN NUMBER IS  
acct_bal NUMBER;  
BEGIN  
SELECT bal INTO acct_bal FROM accts  
WHERE acct_no = acct_id;  
RETURN acct_bal;  
END;
```

In a JDBC program, a call to the `balance` function can be written as follows:

```
...  
CallableStatement cstmt = conn.prepareCall("{? = CALL balance(?)}");  
cstmt.registerOutParameter(1, Types.FLOAT);  
cstmt.setInt(2, acctNo);  
cstmt.executeUpdate();  
float acctBal = cstmt.getFloat(1);  
...
```

8.6 How Oracle JVM Handles Exceptions

Java exceptions are objects and have a naming and inheritance hierarchy. As a result, you can substitute a subexception, that is, a subclass of an exception class, for its superexception, that is, the superclass of an exception class.

All Java exception objects support the `toString()` method, which returns the fully qualified name of the exception class concatenated to an optional string. Typically, the string contains data-dependent information about the exceptional condition. Usually, the code that constructs the exception associates the string with it.

When a Java stored procedure runs a SQL statement, any exception thrown is materialized to the procedure as a subclass of `java.sql.SQLException`. This class has the `getErrorCode()` and `getMessage()` methods, which return the Oracle error code and message, respectively.

If a stored procedure called from SQL or PL/SQL throws an exception and is not caught by Java, then the following error message appears:

```
ORA-29532 Java call terminated by uncaught Java exception
```

This is how all uncaught exceptions, including non-SQL exceptions, are reported.

9

Java Stored Procedures Application Example

This chapter describes how to build a Java application with stored procedures.

This chapter contains the following steps, from the design phase to the actual implementation, to develop a sample application:

- [About Planning the Database Schema](#)
- [Creating the Database Tables](#)
- [Writing the Java Classes](#)
- [Loading the Java Classes](#)
- [Publishing the Java Classes](#)
- [Calling the Java Stored Procedures](#)

9.1 About Planning the Database Schema

The objective of this example is to develop a simple system for managing customer purchase orders. To do this, you must devise a database schema plan. First, identify the business entities involved and their relationships. In this example, the basic entities are customers, purchase orders, line items, and stock items. So, you can have the following tables in the schema:

- Customers
- Orders
- LineItems
- StockItems

The `Customers` table has a one-to-many relationship with the `Orders` table because a customer can place one or many orders, but a given purchase order can be placed by only one customer. The relationship is optional because zero customers may place a given order. For example, an order may be placed by someone previously not defined as a customer.

The `Orders` table has a many-to-many relationship with the `StockItems` table because a purchase order can refer to many stock items, and a stock item can be referred to by many purchase orders. However, you do not know which purchase orders refer to which stock items. As a result, you introduce the notion of a line item. The `Orders` table has a one-to-many relationship with the `LineItems` table because a purchase order can list many line items, but a given line item can be listed by only one purchase order.

The `LineItems` table has a many-to-one relationship with the `StockItems` table because a line item can refer to only one stock item, but a given stock item can be referred to by many line items. The relationship is optional because zero line items may refer to a given stock item.

Figure 9-1 depicts the relationships between tables. In the schema plan, you establish these relationships using primary and foreign keys.

A primary key is a column or combination of columns whose values uniquely identify each row in a table. A foreign key is a column or combination of columns whose values match the primary key in some other table. For example, the `PONo` column in the `LineItems` table is a foreign key matching the primary key in the `Orders` table. Every purchase order number in the `LineItems.PONo` column must also appear in the `Orders.PONo` column.

Figure 9-1 Schema Plan for Purchase Order Application

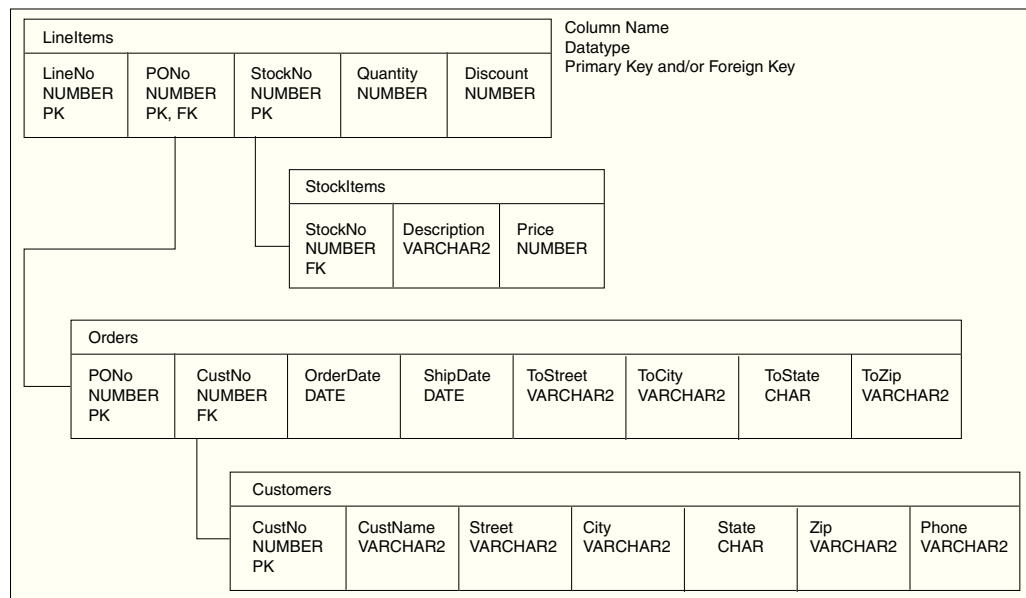

9.2 Creating the Database Tables

After planning the database schema, create the database tables for the schema plan. Define the `Customers` table as follows:

```
CREATE TABLE Customers (
  CustNo NUMBER(3) NOT NULL,
  CustName VARCHAR2(30) NOT NULL,
  Street VARCHAR2(20) NOT NULL,
  City VARCHAR2(20) NOT NULL,
  State CHAR(2) NOT NULL,
  Zip VARCHAR2(10) NOT NULL,
  Phone VARCHAR2(12),
  PRIMARY KEY (CustNo)
);
```

The `Customers` table stores information about customers. Essential information is defined as `NOT NULL`. For example, every customer must have a shipping address. However, the `Customers` table does not manage the relationship between a customer and his or her purchase order. As a result, this relationship must be managed by the `Orders` table, which you can define as follows:

```
CREATE TABLE Orders (  
  PONO NUMBER(5),  
  Custno NUMBER(3) REFERENCES Customers,  
  OrderDate DATE,  
  ShipDate DATE,  
  ToStreet VARCHAR2(20),  
  ToCity VARCHAR2(20),  
  ToState CHAR(2),  
  ToZip VARCHAR2(10),  
  PRIMARY KEY (PONO)  
);
```

The line items have a relationship with purchase orders and stock items. The `LineItems` table manages these relationships using foreign keys. For example, the `StockNo` foreign key column in the `LineItems` table references the `StockNo` primary key column in the `StockItems` table, which you can define as follows:

```
CREATE TABLE StockItems (  
  StockNo NUMBER(4) PRIMARY KEY,  
  Description VARCHAR2(20),  
  Price NUMBER(6,2)  
);
```

The `Orders` table manages the relationship between a customer and purchase order using the `CustNo` foreign key column, which references the `CustNo` primary key column in the `Customers` table. However, the `Orders` table does not manage the relationship between a purchase order and its line items. As a result, this relationship must be managed by the `LineItems` table, which you can define as follows:

```
CREATE TABLE LineItems (  
  LineNo NUMBER(2),  
  PONO NUMBER(5) REFERENCES Orders,  
  StockNo NUMBER(4) REFERENCES StockItems,  
  Quantity NUMBER(2),  
  Discount NUMBER(4,2),  
  PRIMARY KEY (LineNo, PONO)  
);
```

9.3 Writing the Java Classes

After creating the database tables, you consider the operations required in a purchase order system and write the appropriate Java methods. In a simple system based on the tables defined in the preceding examples, you need methods for registering customers, stocking parts, entering orders, and so on. You can implement these methods in a Java class, `POManager`, as follows:

```
import java.sql.*;  
import java.io.*;  
import oracle.jdbc.*;  
  
public class POManager  
{  
  public static void addCustomer (int custNo, String custName, String street,  
    String city, String state, String zipCode, String phoneNo) throws SQLException  
  {  
    String sql = "INSERT INTO Customers VALUES (?, ?, ?, ?, ?, ?, ?)";  
    try  
    {  
      Connection conn = DriverManager.getConnection("jdbc:default:connection");
```

```
        PreparedStatement pstmt = conn.prepareStatement(sql);
        pstmt.setInt(1, custNo);
        pstmt.setString(2, custName);
        pstmt.setString(3, street);
        pstmt.setString(4, city);
        pstmt.setString(5, state);
        pstmt.setString(6, zipCode);
        pstmt.setString(7, phoneNo);
        pstmt.executeUpdate();
        pstmt.close();
    }
    catch (SQLException e)
    {
        System.err.println(e.getMessage());
    }
}

public static void addStockItem (int stockNo, String description, float price)
                                throws SQLException
{
    String sql = "INSERT INTO StockItems VALUES (?, ?, ?)";
    try
    {
        Connection conn = DriverManager.getConnection("jdbc:default:connection:");
        PreparedStatement pstmt = conn.prepareStatement(sql);
        pstmt.setInt(1, stockNo);
        pstmt.setString(2, description);
        pstmt.setFloat(3, price);
        pstmt.executeUpdate();
        pstmt.close();
    }
    catch (SQLException e)
    {
        System.err.println(e.getMessage());
    }
}

public static void enterOrder (int orderNo, int custNo, String orderDate,
    String shipDate, String toStreet, String toCity, String toState,
    String toZipCode) throws SQLException
{
    String sql = "INSERT INTO Orders VALUES (?, ?, ?, ?, ?, ?, ?, ?)";
    try
    {
        Connection conn = DriverManager.getConnection("jdbc:default:connection:");
        PreparedStatement pstmt = conn.prepareStatement(sql);
        pstmt.setInt(1, orderNo);
        pstmt.setInt(2, custNo);
        pstmt.setString(3, orderDate);
        pstmt.setString(4, shipDate);
        pstmt.setString(5, toStreet);
        pstmt.setString(6, toCity);
        pstmt.setString(7, toState);
        pstmt.setString(8, toZipCode);
        pstmt.executeUpdate();
        pstmt.close();
    }
    catch (SQLException e)
    {
        System.err.println(e.getMessage());
    }
}
```

```
}

public static void addLineItem (int lineNo, int orderNo, int stockNo,
    int quantity, float discount) throws SQLException
{
    String sql = "INSERT INTO LineItems VALUES (?, ?, ?, ?, ?)";
    try
    {
        Connection conn = DriverManager.getConnection("jdbc:default:connection:");
        PreparedStatement pstmt = conn.prepareStatement(sql);
        pstmt.setInt(1, lineNo);
        pstmt.setInt(2, orderNo);
        pstmt.setInt(3, stockNo);
        pstmt.setInt(4, quantity);
        pstmt.setFloat(5, discount);
        pstmt.executeUpdate();
        pstmt.close();
    }
    catch (SQLException e)
    {
        System.err.println(e.getMessage());
    }
}

public static void totalOrders () throws SQLException
{
    String sql = "SELECT O.PONo, ROUND(SUM(S.Price * L.Quantity)) AS TOTAL " +
        "FROM Orders O, LineItems L, StockItems S " +
        "WHERE O.PONo = L.PONo AND L.StockNo = S.StockNo " +
        "GROUP BY O.PONo";
    try
    {
        Connection conn = DriverManager.getConnection("jdbc:default:connection:");
        PreparedStatement pstmt = conn.prepareStatement(sql);
        ResultSet rset = pstmt.executeQuery();
        printResults(rset);
        rset.close();
        pstmt.close();
    }
    catch (SQLException e)
    {
        System.err.println(e.getMessage());
    }
}

static void printResults (ResultSet rset) throws SQLException
{
    String buffer = "";
    try
    {
        ResultSetMetaData meta = rset.getMetaData();
        int cols = meta.getColumnCount(), rows = 0;
        for (int i = 1; i <= cols; i++)
        {
            int size = meta.getPrecision(i);
            String label = meta.getColumnLabel(i);
            if (label.length() > size)
                size = label.length();
            while (label.length() < size)
                label += " ";
            buffer = buffer + label + " ";
        }
    }
}
```

```
    }
    buffer = buffer + "\n";
    while (rset.next())
    {
        rows++;
        for (int i = 1; i <= cols; i++)
        {
            int size = meta.getPrecision(i);
            String label = meta.getColumnLabel(i);
            String value = rset.getString(i);
            if (label.length() > size)
                size = label.length();
            while (value.length() < size)
                value += " ";
            buffer = buffer + value + " ";
        }
        buffer = buffer + "\n";
    }
    if (rows == 0)
        buffer = "No data found!\n";
    System.out.println(buffer);
}
catch (SQLException e)
{
    System.err.println(e.getMessage());
}
}

public static void checkStockItem (int stockNo) throws SQLException
{
    String sql = "SELECT O.PONo, O.CustNo, L.StockNo, " +
        "L.LineNo, L.Quantity, L.Discount " +
        "FROM Orders O, LineItems L " +
        "WHERE O.PONo = L.PONo AND L.StockNo = ?";
    try
    {
        Connection conn = DriverManager.getConnection("jdbc:default:connection:");
        PreparedStatement pstmt = conn.prepareStatement(sql);
        pstmt.setInt(1, stockNo);
        ResultSet rset = pstmt.executeQuery();
        printResults(rset);
        rset.close();
        pstmt.close();
    }
    catch (SQLException e)
    {
        System.err.println(e.getMessage());
    }
}

public static void changeQuantity (int newQty, int orderNo, int stockNo)
    throws SQLException
{
    String sql = "UPDATE LineItems SET Quantity = ? " +
        "WHERE PONo = ? AND StockNo = ?";
    try
    {
        Connection conn = DriverManager.getConnection("jdbc:default:connection:");
        PreparedStatement pstmt = conn.prepareStatement(sql);
        pstmt.setInt(1, newQty);
        pstmt.setInt(2, orderNo);
    }
}
```

```

        pstmt.setInt(3, stockNo);
        pstmt.executeUpdate();
        pstmt.close();
    }
    catch (SQLException e)
    {
        System.err.println(e.getMessage());
    }
}

public static void deleteOrder (int orderNo) throws SQLException
{
    String sql = "DELETE FROM LineItems WHERE PONo = ?";
    try
    {
        Connection conn = DriverManager.getConnection("jdbc:default:connection:");
        PreparedStatement pstmt = conn.prepareStatement(sql);
        pstmt.setInt(1, orderNo);
        pstmt.executeUpdate();
        sql = "DELETE FROM Orders WHERE PONo = ?";
        pstmt = conn.prepareStatement(sql);
        pstmt.setInt(1, orderNo);
        pstmt.executeUpdate();
        pstmt.close();
    }
    catch (SQLException e)
    {
        System.err.println(e.getMessage());
    }
}
}
}

```

9.4 Loading the Java Classes

After writing the Java classes, use the `loadjava` tool to upload your Java stored procedures into Oracle Database, as follows:

```

> loadjava -u HR@myPC:1521:orcl -v -r -t POManager.java
Password: password
initialization complete
loading : POManager
creating : POManager
resolver : resolver ( ("*" HR) ("*" public) ("*" -) )
resolving: POManager

```

The `-v` option enables the verbose mode, the `-r` option compiles uploaded Java source files and resolves external references in the classes, and the `-t` option tells the `loadjava` tool to connect to the database using the client-side JDBC Thin driver.

9.5 Publishing the Java Classes

After loading the Java classes, publish your Java stored procedures in the Oracle data dictionary. To do this, you must write call specifications that map Java method names, parameter types, and return types to their SQL counterparts.

The methods in the `POManager` Java class are logically related. You can group their call specifications in a PL/SQL package. To do this, first, create the package specification, as follows:

```
CREATE OR REPLACE PACKAGE po_mgr AS
PROCEDURE add_customer (cust_no NUMBER, cust_name VARCHAR2,
street VARCHAR2, city VARCHAR2, state CHAR, zip_code VARCHAR2,
phone_no VARCHAR2);
PROCEDURE add_stock_item (stock_no NUMBER, description VARCHAR2,
price NUMBER);
PROCEDURE enter_order (order_no NUMBER, cust_no NUMBER,
order_date VARCHAR2, ship_date VARCHAR2, to_street VARCHAR2,
to_city VARCHAR2, to_state CHAR, to_zip_code VARCHAR2);
PROCEDURE add_line_item (line_no NUMBER, order_no NUMBER,
stock_no NUMBER, quantity NUMBER, discount NUMBER);
PROCEDURE total_orders;
PROCEDURE check_stock_item (stock_no NUMBER);
PROCEDURE change_quantity (new_qty NUMBER, order_no NUMBER,
stock_no NUMBER);
PROCEDURE delete_order (order_no NUMBER);
END po_mgr;
```

Then, create the package body by writing call specifications for the Java methods, as follows:

```
CREATE OR REPLACE PACKAGE BODY po_mgr AS
PROCEDURE add_customer (cust_no NUMBER, cust_name VARCHAR2,
street VARCHAR2, city VARCHAR2, state CHAR, zip_code VARCHAR2,
phone_no VARCHAR2) AS LANGUAGE JAVA
NAME 'POManager.addCustomer(int, java.lang.String,
java.lang.String, java.lang.String, java.lang.String,
java.lang.String, java.lang.String)';

PROCEDURE add_stock_item (stock_no NUMBER, description VARCHAR2,
price NUMBER) AS LANGUAGE JAVA
NAME 'POManager.addStockItem(int, java.lang.String, float)';

PROCEDURE enter_order (order_no NUMBER, cust_no NUMBER,
order_date VARCHAR2, ship_date VARCHAR2, to_street VARCHAR2,
to_city VARCHAR2, to_state CHAR, to_zip_code VARCHAR2)
AS LANGUAGE JAVA
NAME 'POManager.enterOrder(int, int, java.lang.String,
java.lang.String, java.lang.String, java.lang.String,
java.lang.String, java.lang.String)';

PROCEDURE add_line_item (line_no NUMBER, order_no NUMBER,
stock_no NUMBER, quantity NUMBER, discount NUMBER)
AS LANGUAGE JAVA
NAME 'POManager.addLineItem(int, int, int, int, float)';

PROCEDURE total_orders
AS LANGUAGE JAVA
NAME 'POManager.totalOrders()';

PROCEDURE check_stock_item (stock_no NUMBER)
AS LANGUAGE JAVA
NAME 'POManager.checkStockItem(int)';

PROCEDURE change_quantity (new_qty NUMBER, order_no NUMBER,
stock_no NUMBER) AS LANGUAGE JAVA
NAME 'POManager.changeQuantity(int, int, int)';

PROCEDURE delete_order (order_no NUMBER)
AS LANGUAGE JAVA
```

```
NAME 'POManager.deleteOrder(int)';  
END po_mgr;
```

9.6 Calling the Java Stored Procedures

After publishing the Java classes, call your Java stored procedures from the top level and from database triggers, SQL data manipulation language (DML) statements, and PL/SQL blocks. Use the dot notation to reference these stored procedures in the `po_mgr` package.

From an anonymous PL/SQL block, you may start the new purchase order system by stocking parts, as follows:

```
BEGIN  
  po_mgr.add_stock_item(2010, 'camshaft', 245.00);  
  po_mgr.add_stock_item(2011, 'connecting rod', 122.50);  
  po_mgr.add_stock_item(2012, 'crankshaft', 388.25);  
  po_mgr.add_stock_item(2013, 'cylinder head', 201.75);  
  po_mgr.add_stock_item(2014, 'cylinder sleeve', 73.50);  
  po_mgr.add_stock_item(2015, 'engine bearing', 43.85);  
  po_mgr.add_stock_item(2016, 'flywheel', 155.00);  
  po_mgr.add_stock_item(2017, 'freeze plug', 17.95);  
  po_mgr.add_stock_item(2018, 'head gasket', 36.75);  
  po_mgr.add_stock_item(2019, 'lifter', 96.25);  
  po_mgr.add_stock_item(2020, 'oil pump', 207.95);  
  po_mgr.add_stock_item(2021, 'piston', 137.75);  
  po_mgr.add_stock_item(2022, 'piston ring', 21.35);  
  po_mgr.add_stock_item(2023, 'pushrod', 110.00);  
  po_mgr.add_stock_item(2024, 'rocker arm', 186.50);  
  po_mgr.add_stock_item(2025, 'valve', 68.50);  
  po_mgr.add_stock_item(2026, 'valve spring', 13.25);  
  po_mgr.add_stock_item(2027, 'water pump', 144.50);  
  COMMIT;  
END;
```

Register your customers, as follows:

```
BEGIN  
  po_mgr.add_customer(101, 'A-1 Automotive', '4490 Stevens Blvd',  
    'San Jose', 'CA', '95129', '408-555-1212');  
  po_mgr.add_customer(102, 'AutoQuest', '2032 America Ave',  
    'Hayward', 'CA', '94545', '510-555-1212');  
  po_mgr.add_customer(103, 'Bell Auto Supply', '305 Cheyenne Ave',  
    'Richardson', 'TX', '75080', '972-555-1212');  
  po_mgr.add_customer(104, 'CarTech Auto Parts', '910 LBJ Freeway',  
    'Dallas', 'TX', '75234', '214-555-1212');  
  COMMIT;  
END;
```

Enter the purchase orders placed by various customers, as follows:

```
BEGIN  
  po_mgr.enter_order(30501, 103, '14-SEP-1998', '21-SEP-1998',  
    '305 Cheyenne Ave', 'Richardson', 'TX', '75080');  
  po_mgr.add_line_item(01, 30501, 2011, 5, 0.02);  
  po_mgr.add_line_item(02, 30501, 2018, 25, 0.10);  
  po_mgr.add_line_item(03, 30501, 2026, 10, 0.05);  
  
  po_mgr.enter_order(30502, 102, '15-SEP-1998', '22-SEP-1998',
```

```
'2032 America Ave', 'Hayward', 'CA', '94545');
po_mgr.add_line_item(01, 30502, 2013, 1, 0.00);
po_mgr.add_line_item(02, 30502, 2014, 1, 0.00);

po_mgr.enter_order(30503, 104, '15-SEP-1998', '23-SEP-1998',
'910 LBJ Freeway', 'Dallas', 'TX', '75234');
po_mgr.add_line_item(01, 30503, 2020, 5, 0.02);
po_mgr.add_line_item(02, 30503, 2027, 5, 0.02);
po_mgr.add_line_item(03, 30503, 2021, 15, 0.05);
po_mgr.add_line_item(04, 30503, 2022, 15, 0.05);

po_mgr.enter_order(30504, 101, '16-SEP-1998', '23-SEP-1998',
'4490 Stevens Blvd', 'San Jose', 'CA', '95129');
po_mgr.add_line_item(01, 30504, 2025, 20, 0.10);
po_mgr.add_line_item(02, 30504, 2026, 20, 0.10);
COMMIT;
END;
```

In SQL*Plus, after redirecting output to the SQL*Plus text buffer, you can call the `totalOrders()` method, as follows:

```
SQL> SET SERVEROUTPUT ON
SQL> CALL dbms_java.set_output(2000);
...
SQL> CALL po_mgr.total_orders();
PONO  TOTAL
30501 1664
30502 275
30503 4149
30504 1635
```

Call completed.

10

Oracle Database Java Application Performance

You can enhance the performance of your Java application using the following:

- [Oracle JVM Just-in-Time Compiler \(JIT\)](#)
- [About Java Memory Usage](#)

10.1 Oracle JVM Just-in-Time Compiler (JIT)

This section describes the just-in-time (JIT) compiler that has been introduced since Oracle Database 11g release 1 (11.1). This section covers the following topics:

- [Overview of Oracle JVM JIT](#)
- [Advantages of JIT Compilation](#)
- [Methods Introduced in Oracle Database 11g](#)

Note:

The JIT compiler is a replacement of the compilers that were used in the earlier versions of Oracle Database.

10.1.1 Overview of Oracle JVM JIT

Starting with Oracle 11g release 1 (11.1), there is a JIT compiler for Oracle JVM environment. A JIT compiler for Oracle JVM enables much faster execution because, it manages the invalidation, recompilation, and storage of code without an external mechanism. Based on dynamically gathered profiling data, this compiler transparently selects Java methods to compile the native machine code and dynamically makes them available to running Java sessions. Additionally, the compiler can take advantage of the class resolution model of Oracle JVM to optionally persist compiled Java methods across database calls, sessions, or instances. Such persistence avoids the overhead of unnecessary recompilations across sessions or instances, when it is known that semantically the Java code has not changed.

The JIT compiler is controlled by a new boolean-valued initialization parameter called `java_jit_enabled`. When running heavily used Java methods with `java_jit_enabled` parameter value as `true`, the Java methods are automatically compiled to native code by the JIT compiler and made available for use by all sessions in the instance. Setting the `java_jit_enabled` parameter to `true` also causes further JIT compilation to cease, and reverts any already compiled methods to be interpreted. The VM automatically recompiles native code for Java methods when necessary, such as following reresolution of the containing Java class.

 **Note:**

On Linux, Oracle JVM JIT uses POSIX shared memory that requires access to the `/dev/shm` directory. The `/dev/shm` directory should be of type `tmpfs` and you must mount this directory as follows:

- With `rw` and `execute` permissions set on it
- Without `noexec` or `nosuid` set on it

If the correct mount options are not used, then the following failure may occur during installation of the database:

```
ORA-29516: Aurora assertion failure: Assertion failure at joez.c:  
Bulk load of method java/lang/Object.<init> failed; insufficient shm-  
object space
```

The JIT compiler runs as an MMON slave, in a single background process for the instance. So, while the JIT compiler is running and actively compiling methods, you may see this background process consuming CPU and memory resources equivalent to an active user Java session.

10.1.2 Advantages of JIT Compilation

The following are the advantages of using JIT compilation over the compilation techniques used in earlier versions of Oracle database:

- JIT compilation works transparently
- JIT compilation speeds up the performance of Java classes
- JIT stored compiled code avoids recompilation of Java programs across sessions or instances when it is known that semantically the Java code has not changed.
- JIT compilation does not require a C compiler
- JIT compilation eliminates some of the array bounds checking
- JIT compilation eliminates common sub-expressions within blocks
- JIT compilation eliminates empty methods
- JIT compilation defines the region for register allocation of local variables
- JIT compilation eliminates the need of flow analysis
- JIT compilation limits inline code

10.1.3 Methods Introduced in Oracle Database 11g

Since 11g release 1 (11.1), the `DBMS_JAVA` package has been enhanced with the following new public methods to provide Java entry points for controlling synchronous method compilation and reverting to interpreted method execution:

set_native_compiler_option

This procedure sets a native-compiler option to the specified value for the current schema. If the option given by *optionName* is not allowed to have duplicate values, then the value is ignored.

```
PROCEDURE set_native_compiler_option(optionName VARCHAR2,  
value VARCHAR2);
```

unset_native_compiler_option

This procedure unsets a native-compiler option/value pair for the current schema. If the option given by *optionName* is not allowed to have duplicate values, then the value is ignored.

```
PROCEDURE unset_native_compiler_option(optionName VARCHAR2,  
value VARCHAR2);
```

compile_class

This function compiles all methods defined by the class that is identified by *classname* in the current schema. It returns the number of methods successfully compiled. If the class does not exist, then an ORA-29532 (Uncaught Java exception) occurs.

```
FUNCTION compile_class(classname VARCHAR2) return NUMBER;
```

uncompile_class

This function uncompiles all methods defined by the class that is identified by *classname* in the current schema. It returns the number of methods successfully uncompiled. If the value of the argument *permanentp* is nonzero, then mark these methods as permanently dynamically uncompileable. Otherwise, they are eligible for future dynamic recompilation. If the class does not exist, then an ORA-29532 (Uncaught Java exception) occurs.

```
FUNCTION uncompile_class(classname VARCHAR2,  
permanentp NUMBER default 0) return NUMBER;
```

compile_method

This function compiles the method specified by *name* and *Java type* signatures defined by the class, which is identified by *classname* in the current schema. It returns the number of methods successfully compiled. If the class does not exist, then an ORA-29532 (Uncaught Java exception) occurs.

```
FUNCTION compile_method(classname VARCHAR2,  
methodname VARCHAR2,  
methodsig VARCHAR2) return NUMBER;
```

uncompile_method

This function uncompiles the method specified by the *name* and *Java type* signatures defined by the class that is identified by *classname* in the current schema. It returns the number of methods successfully uncompiled. If the value of the argument *permanentp* is nonzero, then mark the method as permanently dynamically uncompileable. Otherwise, it is eligible for future dynamic recompilation. If the class does not exist, then an ORA-29532 (Uncaught Java exception) occurs.

```
FUNCTION uncompile_method(classname VARCHAR2,  
methodname VARCHAR2,  
methodsig VARCHAR2,  
permanentp NUMBER default 0) return NUMBER;
```

10.2 About Java Memory Usage

The typical and custom database installation process furnishes a database that has been configured for reasonable Java usage during development. However, run-time use of Java should be determined by the usage of system resources for a given deployed application. Resources you use during development can vary widely, depending on your activity. The following sections describe how you can configure memory, how to tell how much System Global Area (SGA) memory you are using, and what errors denote a Java memory issue:

- [Configuring Memory Initialization Parameters](#)
- [About Java Pool Memory](#)
- [Displaying Used Amounts of Java Pool Memory](#)
- [Correcting Out of Memory Errors](#)
- [Displaying Java Call and Session Heap Statistics](#)

10.2.1 Configuring Memory Initialization Parameters

You can modify the following database initialization parameters to tune your memory usage to reflect your application needs more accurately:

- `SHARED_POOL_SIZE`

Shared pool memory is used by the class loader within the JVM. The class loader, on an average, uses about 8 KB of memory for each loaded class. Shared pool memory is used when loading and resolving classes into the database. It is also used when compiling the source in the database or when using Java resource objects in the database.

The memory specified in `SHARED_POOL_SIZE` is consumed transiently when you use the `loadjava` tool. The database initialization process requires `SHARED_POOL_SIZE` to be set to 96 MB because it loads the Java binaries for approximately 8,000 classes and resolves them. The `SHARED_POOL_SIZE` resource is also consumed when you create call specifications and as the system tracks dynamically loaded Java classes at run time.
- `JAVA_POOL_SIZE`

Oracle JVM memory manager uses `JAVA_POOL_SIZE` mainly for in-memory representation of Java method and class definitions, and static Java states that are migrated to session space at end-of-call in shared server mode. In the first case, you will be sharing the memory cost with all Java users. In the second case, the value of `JAVA_POOL_SIZE` varies according to the actual amount of state held in static variables for each session. But, Oracle recommends the minimum value as 50 MB.
- `JAVA_SOFT_SESSIONSPACE_LIMIT`

This parameter lets you specify a soft limit on Java memory usage in a session, which will warn you if you must increase your Java memory limits. Every time memory is allocated, the total memory allocated is checked against this limit.

When a user's session Java state exceeds this size, Oracle JVM generates a warning that is written into the trace files. Although this warning is an informational message and has no impact on your application, you should understand and manage the memory requirements of your deployed classes, especially as they relate to usage of session space.

 **Note:**

This parameter is applicable only to a shared-server environment.

- `JAVA_MAX_SESSIONSPACE_SIZE`

If a Java program, which can be called by a user, running in the server can be used in a way that is not self-limiting in its memory usage, then this setting may be useful to place a hard limit on the amount of session space made available to it. The default is 4 GB. This limit is purposely set extremely high to be usually invisible.

When a user's session Java state attempts to exceeds this size, the application can receive an out-of-memory failure.

 **Note:**

This parameter is applicable only to a shared-server environment.

10.2.1.1 Initializing Pool Sizes within Database Templates

You can set the defaults for the following parameters in the database installation template:

- `JAVA_POOL_SIZE`
- `SHARED_POOL_SIZE`

[Figure 10-1](#) illustrates how the Database Configuration Assistant enables you to modify these values in the Memory section.

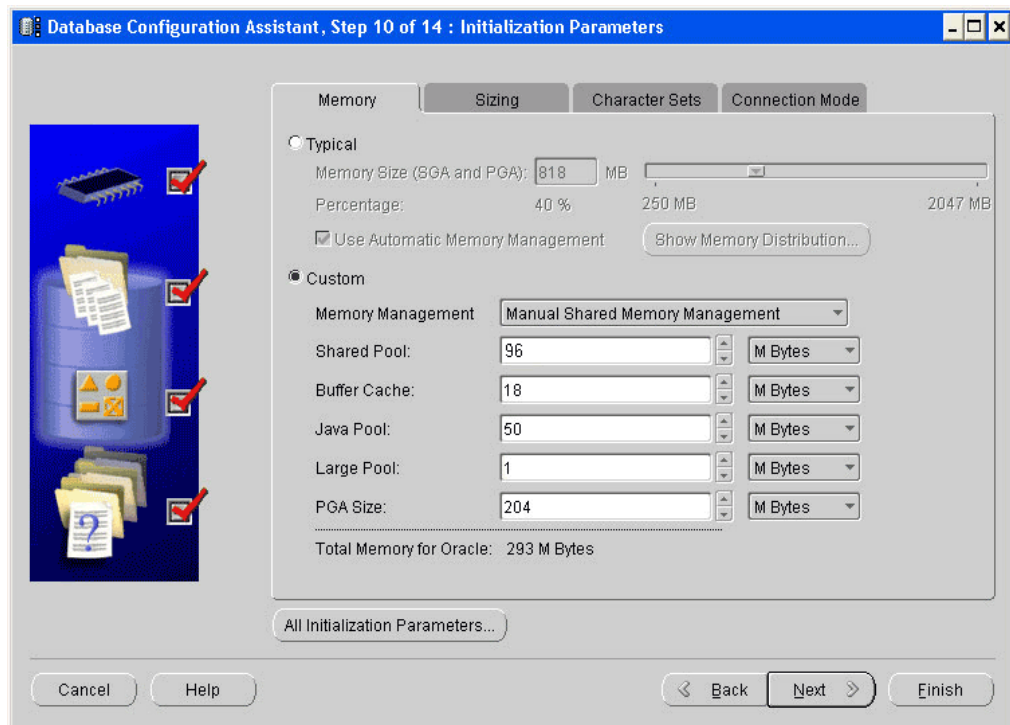
Figure 10-1 Configuring Oracle JVM Memory Parameters

10.2.2 About Java Pool Memory

Java pool memory is a subset of SGA, which is used exclusively by Java for memory that must be aligned pagewise. This includes the majority, but, not all of the memory used for the shared definitions of Java classes. Other uses of Java pool memory depend on the mode in which the Oracle Database server runs.

Java Pool Memory Used within a Dedicated Server

The following is what constitutes the Java pool memory used within a dedicated server:

- Most of the shared part of each Java class in use.
This includes read-only memory, such as code vectors, and methods. In total, this can average about 4 KB to 8 KB for each class.
- None of the per-session Java state of each session.
For a dedicated server, this is stored in the User Global Area (UGA) within the Program Global Area (PGA), and not within the SGA.

Under dedicated servers, the total required Java pool memory depends on the applications running and usually ranges between 10 and 50 MB.

Java Pool Memory Used within a Shared Server

The following constitutes the Java pool memory used within a shared server:

- Most of the shared part of each Java class in use

This includes read-only memory, such as vectors and methods. In total, this memory usually averages to be about 4 KB to 8 KB for each class.

- Some of the UGA for per session memory

In particular, the memory for objects that remain in use across Database calls is always allocated from Java pool.

Because the Java pool memory size is limited, you must estimate the total requirement for your applications and multiply by the number of concurrent sessions the applications want to create, to calculate the total amount of necessary Java pool memory. Each UGA grows and shrinks as necessary. However, all UGAs combined must be able to fit within the entire fixed Java pool space.

Under shared servers, Java pool could be large. Java-intensive, multiuser applications could require more than 100 MB.

Note:

If you are compiling code on the server, rather than compiling on the client and loading to the server, then you might need a bigger `JAVA_POOL_SIZE` than the default 20 MB.

Reducing the Number of Java-Enabled Sessions

The top-level invocation of Java in the database is issued by a client-side application or utility. If each client has a dedicated server, then large-scale deployment involves significant consumption of resources on the database server and also leads to resource wastage. You can use Client-side connection pools or Database Resident Connection Pool (DRCP) to reduce the number of database processes and sessions.

See Also:

Oracle Database JDBC Developer's Guide for more information about DRCP

10.2.3 Displaying Used Amounts of Java Pool Memory

You can find out how much of Java pool memory is being used by viewing the `V$SGASTAT` table. Its rows include pool, name, and bytes. Specifically, the last two rows show the amount of Java pool memory used and how much is free. The total of these two items equals the number of bytes that you configured in the database initialization file.

```
SVRMGR> select * from v$sgastat;
```

POOL	NAME	BYTES
-----	-----	-----
	fixed_sga	69424
	db_block_buffers	2048000
	log_buffer	524288
shared pool	free memory	22887532
shared pool	miscellaneous	559420

shared pool character set object	64080
shared pool State objects	98504
shared pool message pool freequeue	231152
shared pool PL/SQL DIANA	2275264
shared pool db_files	72496
shared pool session heap	59492
shared pool joxlod: init P	7108
shared pool PLS non-lib hp	2096
shared pool joxlod: in ehe	4367524
shared pool VIRTUAL CIRCUITS	162576
shared pool joxlod: in phe	2726452
shared pool long op statistics array	44000
shared pool table definiti	160
shared pool KGK heap	4372
shared pool table columns	148336
shared pool db_block_hash_buckets	48792
shared pool dictionary cache	1948756
shared pool fixed allocation callback	320
shared pool SYSTEM PARAMETERS	63392
shared pool joxlod: init s	7020
shared pool KQLS heap	1570992
shared pool library cache	6201988
shared pool trigger inform	32876
shared pool sql area	7015432
shared pool sessions	211200
shared pool KGFF heap	1320
shared pool joxs heap init	4248
shared pool PL/SQL MPCODE	405388
shared pool event statistics per sess	339200
shared pool db_block_buffers	136000
java pool free memory	30261248
java pool memory in use	19742720

37 rows selected.

10.2.4 Correcting Out of Memory Errors

If you run out of memory while loading classes, then it can fail silently, leaving invalid classes in the database. Later, if you try to call or resolve any invalid classes, then a `ClassNotFoundException` or `NoClassDefFoundException` instance will be thrown at run time. You would get the same exceptions if you were to load corrupted class files. You should perform the following:

- Verify that the class was actually included in the set you are loading to the server.
- Use the `loadjava -force` option to force the new class being loaded to replace the class already resident in the server.
- Use the `loadjava -resolve` option to attempt resolution of a class during the load process. This enables you to catch missing classes at load time, rather than at run time.
- Double check the status of the newly loaded class by connecting to the database in the schema containing the class, and run the following:

```
SELECT * FROM user_objects WHERE object_name = dbms_java.shortname('');
```

The `STATUS` field should be `VALID`. If the `loadjava` tool complains about memory problems or failures, such as lost connection, then increase `SHARED_POOL_SIZE` and `JAVA_POOL_SIZE`, and try again.

10.2.5 Displaying Java Call and Session Heap Statistics

Database performance view `v$sesstat` records a number of Java memory usage statistics. These statistics are updated often during Java calls. The following example shows the Java call return and session heap statistics for the database session with `SID=102`.

```
SQL> select s.sid, n.name p_name, st.value from v$session s, v$sesstat st,
v$statname n where s.sid=102
and s.sid=st.sid and n.statistic# = st.statistic# and n.name like 'java%';
```

SID	P_NAME	VALUE
102	java call heap total size	6815744
102	java call heap total size max	6815744
102	java call heap used size	668904
102	java call heap used size max	846920
102	java call heap live size	667112
102	java call heap live size max	704312
102	java call heap object count	13959
102	java call heap object count max	17173
102	java call heap live object count	13907
102	java call heap live object count max	14916
102	java call heap gc count	432433
102	java call heap collected count	123196423
102	java call heap collected bytes	5425972216
102	java session heap used size	444416
102	java session heap used size max	444416
102	java session heap live size	444416
102	java session heap live size max	444416
102	java session heap object count	0
102	java session heap object count max	0
102	java session heap live object count	0
102	java session heap live object count max	0
102	java session heap gc count	0
102	java session heap collected count	0
102	java session heap collected bytes	0

24 rows selected.

11

Security for Oracle Database Java Applications

Security is a large arena that includes network security for the connection, access, and execution control of operating system resources or of Java virtual machine (JVM)-defined and user-defined classes. Security also includes bytecode verification of Java Archive (JAR) files imported from an external source. This chapter describes the various security support available for Java applications within Oracle Database:

- [Network Connection Security](#)
- [Database Contents and Oracle JVM Security](#)
- [Database Authentication Mechanisms Available with Oracle JVM](#)
- [Secure Use of Runtime.exec Functionality in Oracle Database](#)

11.1 Network Connection Security

The two major aspects to network security are authentication and data confidentiality. The type of authentication and data confidentiality is dependent on how you connect to the database, either through Oracle Net or Java Database Connectivity (JDBC) connection. The following table provides the security description for Oracle Net and JDBC connections:

Connection Security	Description
Oracle Net	The database can require both authentication and authorization before allowing a user to connect to it. Oracle Net database connection security can require one or more of the following: <ul style="list-style-type: none">• A user name and password for client verification. For each connection request, a user name and password configured within Oracle Net has to be provided.• Advanced Networking Option for encryption, kerberos, or secureId.• SSL for certificate authentication.
JDBC	The JDBC connection security that is required is similar to the constraints required on an Oracle Net database connection.

See Also:

- *Oracle Database Net Services Administrator's Guide*
- *Oracle Database Security Guide*
- *Oracle Database JDBC Developer's Guide*

11.2 Database Contents and Oracle JVM Security

Once you are connected to the database, you must have the appropriate Java 2 security permissions and database privileges to access the resources stored within the database. These resources include:

- Database resources, such as tables and PL/SQL packages
- Operating system resources, such as files and sockets
- Oracle JVM classes
- User-loaded classes

These resources can be protected by the following methods:

Resource Security	Description
Database Resource Security	<p>Authorization for database resources requires that database privileges, which are not the same as the Java 2 security permissions, are granted to resources. For example, database resources include tables, classes, and PL/SQL packages.</p> <p>All user-defined classes are secured against users from other schemas. You can grant execution permission to other users or schemas through an option on the <code>loadjava</code> tool.</p>
JVM Security	<p>Oracle JVM uses Java 2 security, which uses <code>Permission</code> objects to protect operating system resources. Java 2 security is automatically installed upon startup and protects all operating system resources and Oracle JVM classes from all users, except <code>JAVA_ADMIN</code>. The <code>JAVA_ADMIN</code> user can grant permission to other users to access these classes.</p>

Note:

- The Oracle JVM is shipped with strong but limited encryption as included in JDK1.5 and JDK 6. If you want to have unlimited encryption strength in your application, then you must download and install the appropriate version-specific files from the following Web site
<http://www.oracle.com/technetwork/indexes/downloads/index.html>
- The Oracle JVM classes used for granting or revoking permissions can run only on a server.

This section covers the following topics:

- [Overview of Java 2 Security Features](#)
- [Overview of Setting Permissions](#)
- [Debugging Permissions](#)
- [Permission for Loading Classes](#)
- [Customizing the Default `java.security` Resource](#)

 **See Also:**

Oracle Database Development Guide

11.2.1 Overview of Java 2 Security Features

Each user or schema must be assigned the proper permissions to access operating system resources, such as sockets, files, and system properties.

Java 2 security provides a flexible and configurable security for Java applications. With Java 2 security, you can define exactly what permissions on each loaded object that a schema or role will have. In Oracle8i Database release 8.1.5, the following secure roles are available:

- `JAVAUSERPRIV`
Few permissions, including examining properties
- `JAVASYSPRIV`
Major permissions, including updating Oracle JVM-protected packages

 **Note:**

Both roles still exist within this release for backward compatibility. However, Oracle recommends that you specify each permission explicitly, rather than utilize these roles.

Because Oracle JVM security is based on Java 2 security, you assign permissions on a class-by-class basis. These permissions are assigned through database management tools. Each permission is encapsulated in a `Permission` object and is stored within a `Permission` table. `Permission` contains the `target` and `action` attributes, which take `String` values.

Java 2 security was created for the non-database world. When you apply the Java 2 security model within the database, certain differences manifest themselves. For example, Java 2 security defines that all applets are implicitly untrusted and all classes within the `CLASSPATH` are trusted. In Oracle Database, all classes are loaded within a secure database. As a result, no classes are trusted.

The following table describes the differences between the standard Java 2 security and Oracle Database security implementation:

Java 2 Security Standard	Oracle Database Security Implementation
Java classes located within the <code>CLASSPATH</code> are trusted.	All Java classes are loaded within the database. Classes are trusted on a class-by-class basis according to the permission granted.
You can specify the policy using the <code>-usepolicy</code> flag on the <code>java</code> command.	You must specify the policy within <code>PolicyTable</code> .

Java 2 Security Standard	Oracle Database Security Implementation
You can write your own <code>SecurityManager</code> or use the Launcher.	You can write your own <code>SecurityManager</code> . However, Oracle recommends that you use only Oracle Database <code>SecurityManager</code> or that you extend it. If you want to modify the behavior, then you should not define a <code>SecurityManager</code> . Instead, you should extend <code>oracle.aurora.rdbms.SecurityManagerImpl</code> and override specific methods.
<code>SecurityManager</code> is not initialized by default. You must initialize <code>SecurityManager</code> .	Oracle JVM always initializes <code>SecurityManager</code> at startup.
Permissions are determined by the location or the URL, where the application or applet is loaded, or keycode, that is, signed code.	Permissions are determined by the schema in which the class is loaded. Oracle Database does not support signed code.
The security policy is defined in a file.	The <code>PolicyTable</code> definition is contained in a secure database table.
You can update the security policy file using a text editor or a tool, if you have the appropriate permissions.	You can update <code>PolicyTable</code> through <code>DBMS_JAVA</code> procedures. After initialization, only <code>JAVA_ADMIN</code> has permission to modify <code>PolicyTable</code> . <code>JAVA_ADMIN</code> must grant you the right to modify <code>PolicyTable</code> so that you can grant permissions to others.
Permissions are assigned to a protection domain, which classes can belong to.	All classes within the same schema are in the same protection domain.
You can use the <code>CodeSource</code> class for identifying code.	You can use the <code>CodeSource</code> class for identifying schema.
<ul style="list-style-type: none"> The <code>equals()</code> method returns <code>true</code> if the URL and certificates are equal. The <code>implies()</code> method returns <code>true</code> if the first <code>CodeSource</code> is a generic representation that includes the specific <code>CodeSource</code> object. 	<ul style="list-style-type: none"> The <code>equals()</code> method returns <code>true</code> if the schemas are the same. The <code>implies()</code> method returns <code>true</code> if the schemas are the same.
Supports positive permissions only, that is, <code>grant</code> .	Supports both positive and limitation permissions, that is, <code>grant</code> and <code>restrict</code> .

11.2.2 Overview of Setting Permissions

As with Java 2 security, Oracle Database supports the security classes. Typically, you set the permissions for the code base either using a tool or by editing the security policy file. In Oracle Database, you set the permissions dynamically using `DBMS_JAVA` procedures, which modify a policy table in the database.

Two views have been created for you to view the policy table, `USER_JAVA_POLICY` and `DBA_JAVA_POLICY`. Both views contain information about granted and limitation permissions. The `DBA_JAVA_POLICY` view can see all rows within the policy table. The `USER_JAVA_POLICY` view can see only permissions relevant to the current user. The following is a description of the rows within each view:

Table Column	Description
Kind	GRANT or RESTRICT. Shows whether this permission is a positive or a limitation permission.
Grantee	The name of the user, schema, or role to which the Permission object is assigned.
Permission_schema	The schema in which the Permission object is loaded.
Permission_type	The Permission class type, which is designated by a string containing the full class name, such as, <code>java.io.FilePermission</code> .
Permission_name	The <code>target</code> attribute of the Permission object. You use this when defining the permission. When defining the target for a Permission object of type <code>PolicyTablePermission</code> , the name can become quite complicated.
Permission_action	The <code>action</code> attribute of the Permission object. Many permissions expect a null value if no action is appropriate for the permission.
Status	ENABLED and DISABLED. After creating a row for a Permission object, you can disable or reenble it. This column shows whether the permission is enabled or disabled.
Key	Sequence number you use to identify this row. This number should be supplied when disabling, enabling, or deleting a permission.

There are two ways to set permissions:

- [Fine-Grain Definition for Each Permission](#)
- [Assigning General Permission Definition to Roles](#)

 **Note:**

For absolute certainty about the security settings, implement the fine-grain definition. The general definition is easy to implement, but you may not get the exact security settings you require.

11.2.2.1 Fine-Grain Definition for Each Permission

Using fine-grain definition, you can grant each permission individually to specific users or roles. If you do not grant a permission for access, then the schema will be denied access. To set individual permissions within the policy table, you must provide the following information:

Parameter	Description
Grantee	The name of the user, schema, or role to which you want the grant to apply. <code>PUBLIC</code> specifies that the row applies to all users.

Parameter	Description
Permission type	The <code>Permission</code> class on which you are granting permission. For example, if you were defining access to a file, the permission type would be <code>FilePermission</code> . This parameter requires a fully-qualified name of a class that extends <code>java.lang.security.Permission</code> . If the class is not within <code>SYS</code> , then the name should be prefixed by <code>schema:.</code> For example, <code>mySchema:myPackage.MyPermission</code> is a valid name for a user-generated permission.
Permission name	The meaning of the target attribute as defined by the <code>Permission</code> class. Examine the appropriate <code>Permission</code> class for the relevant name.
Permission action	The type of action that you can specify. This can vary according to the permission type. For example, <code>FilePermission</code> can have the action, <code>read</code> or <code>write</code> .
Key	Number returned from <code>grant</code> or <code>limit</code> to use on <code>enable</code> , <code>disable</code> , or <code>delete</code> methods.

11.2.2.1.1 Granting and Limiting Permissions

You can grant permissions using either SQL or Java. Each version returns a row key identifier that identifies the row within the permission table. In the Java version of `DBMS_JAVA`, each method returns the row key identifier, either as a returned parameter or as an `OUT` variable in the parameter list. In the PL/SQL `DBMS_JAVA` package, the row key is returned only in the procedure that defines the `key OUT` parameter. This key is used to enable and disable specific permissions.

After running the `grant`, if a row already exists for the exact permission, then no update occurs, but the key for that row is returned. If the row was disabled, then running the `grant` enables the existing row.

Note:

If you are granting `FilePermission`, then you must provide the physical name of the directory or file, such as `/private/oracle`. You cannot provide either an environment variable, such as `$ORACLE_HOME`, or a symbolic link. To denote all files within a directory, provide the `*` symbol, as follows:

```
/private/oracle/*
```

To denote all directories and files within a directory, provide the `-` symbol, as follows:

```
/private/oracle/-
```

You can grant permissions using the `DBMS_JAVA` package, as follows:

```
procedure grant_permission ( grantee varchar2, permission_type varchar2,
permission_name varchar2,
permission_action varchar2 )
```

```
procedure grant_permission ( grantee varchar2, permission_type varchar2,
```

```
permission_name varchar2,
permission_action varchar2, key OUT number)
```

You can grant permissions using Java, as follows:

```
long oracle.aurora.rdbms.security.PolicyTableManager.grant ( java.lang.String
grantee,
java.lang.String permission_type, java.lang.String permission_name, java.lang.String
permission_action);
```

```
void oracle.aurora.rdbms.security.PolicyTableManager.grant ( java.lang.String
grantee,
java.lang.String permission_type, java.lang.String permission_name, java.lang.String
permission_action, long[] key);
```

You can limit permissions using the `DBMS_JAVA` package, as follows:

```
procedure restrict_permission ( grantee varchar2, permission_type varchar2,
permission_name varchar2,
permission_action varchar2)
```

```
procedure restrict_permission ( grantee varchar2, permission_type varchar2,
permission_name varchar2,
permission_action varchar2, key OUT number)
```

You can limit permissions using Java, as follows:

```
long oracle.aurora.rdbms.security.PolicyTableManager.restrict ( java.lang.String
grantee,
java.lang.String permission_type, java.lang.String permission_name, java.lang.String
permission_action);
```

```
void oracle.aurora.rdbms.security.PolicyTableManager.restrict ( java.lang.String
grantee,
java.lang.String permission_type, java.lang.String permission_name, java.lang.String
permission_action, long[] key);
```

[Example 11-1](#) shows how to use the `grant_permission()` method to grant permissions. [Example 11-2](#) shows how to limit permissions using the `restrict()` method.

The following examples perform the following actions:

1. Grants everyone read and write permission to all files in `/tmp`.
2. Limits everyone from reading or writing only the `password` file in `/tmp`.
3. Grants only Larry explicit permission to read and write the `password` file.

Example 11-1 Granting Permissions

Assuming that you have appropriate permissions to modify the policy table, you can use the `grant_permission()` method, which is in the `DBMS_JAVA` package, to modify `PolicyTable` to allow user access to the indicated file. In this example, the user, Larry, has modification permission on `PolicyTable`. Within a SQL package, Larry can grant permission to Dave to read and write a file, as follows:

```
connect larry
Enter password: password

REM Grant DAVE permission to read and write the Test1 file.
call dbms_java.grant_permission('DAVE', 'java.io.FilePermission', '/test/Test1',
```

```
'read,write');

REM commit the changes to PolicyTable
commit;
```

Example 11-2 Limiting Permissions

You can use the `restrict()` method to specify a limitation or exception to general rules. A general rule is a rule where, in most cases, the permission is true or granted. However, there may be exceptions to this rule. For these exceptions, you specify a limitation permission.

If you have defined a general rule that no one can read or write an entire directory, then you can define a limitation on an aspect of this rule through the `restrict()` method. For example, if you want to allow access to all files within the `/tmp` directory, except for your password file that exists in that directory, then you would grant permission for read and write to all files within `/tmp` and limit read and write access to the password file.

If you want to specify an exception to the limitation, then you must create an explicit grant permission to override the limitation permission. In the previously mentioned scenario, if you want the file owner to still be able to modify the password file, then you can grant a more explicit permission to allow access to one user, which will override the limitation. Oracle JVM security combines all rules to understand who really has access to the password file. This is demonstrated in the following diagram:

Figure 11-1 The List of Files in the /tmp Directory

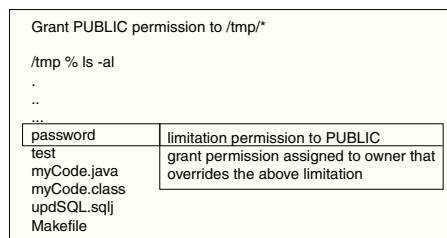

The explicit rule is as follows:

If the limitation permission implies the request, then for a grant permission to be effective, the limitation permission must also imply the grant.

The following code implements this example:

```
connect larry
Enter password: password

REM Grant permission to all users (PUBLIC) to be able to read and write
REM all files in /tmp.
call dbms_java.grant_permission('PUBLIC', 'java.io.FilePermission', '/tmp/*',
'read,write');

REM Limit permission to all users (PUBLIC) from reading or writing the
REM password file in /tmp.
call dbms_java.restrict_permission('PUBLIC', 'java.io.FilePermission', '/tmp/
password', 'read,write');

REM By providing a more specific rule that overrides the limitation,
```

```

REM Larry can read and write /tmp/password.
call dbms_java.grant_permission('LARRY', 'java.io.FilePermission', '/tmp/password',
'read,write');

commit;

```

11.2.2.1.2 Acquiring Administrative Permission to Update Policy Table

All permissions are rows in `PolicyTable`. Because it is a table in the database, you need appropriate permissions to modify it. Specifically, the `PolicyTablePermission` object is required to modify the table. After initializing Oracle JVM, only a single role, `JAVA_ADMIN`, is granted `PolicyTablePermission` to modify `PolicyTable`. The `JAVA_ADMIN` role is immediately assigned to the database administrator (DBA). Therefore, if you are assigned to the DBA group, then you will automatically take on all `JAVA_ADMIN` permissions.

If you need to add permissions as rows to this table, `JAVA_ADMIN` must grant your schema update rights using `PolicyTablePermission`. This permission defines that your schema can add rows to the table. Each `PolicyTablePermission` is for a specific type of permission. For example, to add a permission that controls access to a file, you must have `PolicyTablePermission` that lets you grant or limit a permission on `FilePermission`. Once this occurs, you have administrative permission for `FilePermission`.

An administrator can grant and limit `PolicyTablePermission` in the same manner as other permissions, but the syntax is complicated. For ease of use, you can use the `grant_policy_permission()` or `grantPolicyPermission()` method to grant administrative permissions.

You can grant policy table administrative permission using `DBMS_JAVA`, as follows:

```

procedure grant_policy_permission ( grantee varchar2, permission_schema varchar2,
permission_type varchar2, permission_name varchar2 )

```

```

procedure grant_policy_permission ( grantee varchar2, permission_schema varchar2,
permission_type varchar2, permission_name varchar2, key OUT number )

```

You can grant policy table administrative permission using Java, as follows:

```

long oracle.aurora.rdbms.security.PolicyTableManager.grantPolicyPermission
(java.lang.String grantee, java.lang.String permission_schema,
java.lang.String permission_type, java.lang.String permission_name);

```

```

void oracle.aurora.rdbms.security.PolicyTableManager.grantPolicyPermission
(java.lang.String grantee, java.lang.String permission_schema,
java.lang.String permission_type, java.lang.String permission_name, long[] key);

```

Parameter	Description
Grantee	The name of the user, schema, or role to which you want the grant to apply. <code>PUBLIC</code> specifies that the row applies to all users.
Permission_schema	The schema where the <code>Permission</code> class is loaded.

Parameter	Description
Permission_type	The <code>Permission</code> class on which you are granting permission. For example, if you were defining access to a file, the permission type would be <code>FilePermission</code> . This parameter requires a fully-qualified name of a class that extends <code>java.lang.security.Permission</code> . If the class is not within <code>SYS</code> , the name should be prefixed by <code>schema:.</code> For example, <code>mySchema:myPackage.MyPermission</code> is a valid name for a user-generated permission.
Permission_name	The meaning of the target attribute as defined by the <code>Permission</code> class. Examine the appropriate <code>Permission</code> class for the relevant name.
Row_number	Number returned from grant or limitation to use on enable, disable, or delete methods.

 **Note:**

When looking at the policy table, the name in the `PolicyTablePermission` rows contains both the permission type and the permission name, which are separated by a #. For example, to grant a user administrative rights for reading a file, the name in the row contains `java.io.FilePermission#read`. The # separates the `Permission` class from the permission name.

[Example 11-3](#) shows how you can modify `PolicyTable`.

Example 11-3 Granting `PolicyTable` Permission

This example shows `SYS`, which has the `JAVA_ADMIN` role assigned, giving Larry permission to update `PolicyTable` for `FilePermission`. Once this permission is granted, Larry can grant permissions to other users for reading, writing, and deleting files.

```
REM Connect as SYS, which is assigned JAVA_ADMIN role, to give Larry permission
REM to modify the PolicyTable
connect SYS as SYSDBA
Enter password: password

REM SYS grants Larry the right to administer permissions for
REM FilePermission
call dbms_java.grant_policy_permission('LARRY', 'SYS', 'java.io.FilePermission',
'*');
```

11.2.2.1.3 Creating Permissions

You can create your own permission type by performing the following steps:

1. Create and load the user permission

Create your own permission by extending the `java.security.Permission` class. Any user-defined permission must extend `Permission`. The following example creates `MyPermission`, which extends `BasicPermission`, which, in turn, extends `Permission`.

```
package test.larry;
import java.security.Permission;
```

```
import java.security.BasicPermission;

public class MyPermission extends BasicPermission
{
    public MyPermission(String name)
    {
        super(name);
    }

    public boolean implies(Permission p)
    {
        boolean result = super.implies(p);
        return result;
    }
}
```

2. Grant administrative and action permissions to specified users

When you create a permission, you are designated as the owner of that permission. The owner is implicitly granted administrative permission. This means that the owner can be an administrator for this permission and can run `grant_policy_permission()`. Administrative permission enable the user to update the policy table for the user-defined permission.

For example, if LARRY creates a permission, `MyPermission`, then only he can call `grant_policy_permission()` for himself or another user. This method updates `PolicyTable` on who can grant rights to `MyPermission`. The following code demonstrates this:

REM Since Larry is the user that owns `MyPermission`, Larry connects to
REW the database to assign permissions for `MyPermission`.

```
connect larry
Enter password: password
```

REM As the owner of `MyPermission`, Larry grants himself the right to
REM administer permissions for `test.larry.MyPermission` within the JVM
REM security `PolicyTable`. Only the owner of the user-defined permission
REM can grant administrative rights.
call `dbms_java.grant_policy_permission ('LARRY', 'LARRY',
'test.larry.MyPermission', '*');`

```
REM commit the changes to PolicyTable
commit;
```

Once you have granted administrative rights, you can grant action permissions for the created permission. For example, the following SQL statements grant LARRY the permission to run anything within `MyPermission` and DAVE the permission to run only actions that start with "act.".

REM Since Larry is the user that creates `MyPermission`, Larry connects to
REW the database to assign permissions for `MyPermission`.

```
connect larry
Enter password: password
```

REM Once able to modify `PolicyTable` for `MyPermission`, Larry grants himself
REM full permission for `MyPermission`. Notice that the Permission is prefixed
REM with its owner schema.
call `dbms_java.grant_permission('LARRY', 'LARRY:test.larry.MyPermission', '*',`

```

null);

REM Larry grants Dave permission to do any actions that start with 'act.*'.
call dbms_java.grant_permission
 ('DAVE', 'LARRY:test.larry.MyPermission', 'act.*', null);

REM commit the changes to PolicyTable
commit;

```

3. Implement security checks using the permission

Once you have created, loaded, and assigned permissions for `MyPermission`, you must implement the call to `SecurityManager` to have the permission checked. There are four methods in the following example: `sensitive()`, `act()`, `print()`, and `hello()`. Because of the permissions granted using SQL in the preceding steps, the following users can run methods within the example class:

- LARRY can run any of the methods.
- DAVE is given permission to run only the `act()` method.
- Anyone can run the `print()` and `hello()` methods. The `print()` method does not check any permissions. As a result, anyone can run it. The `hello()` method runs `AccessController.doPrivileged()`, which means that the method runs with the permissions assigned to LARRY. This is referred to as the definer's rights.

```

package test.larry;
import java.security.AccessController;
import java.security.Permission;
import java.security.PrivilegedAction;

import java.sql.Connection;
import java.sql.SQLException;

/**
 * MyActions is a class with a variety of public methods that
 * have some security risks associated with them. We will rely
 * on the Java security mechanisms to ensure that they are
 * performed only by code that is authorized to do so.
 */

public class Larry {

    private static String secret = "Larry's secret";
    MyPermission sensitivePermission = new MyPermission("sensitive");

    /**
     * This is a security sensitive operation. That is it can
     * compromise our security if it is executed by a "bad guy".
     * Only larry has permission to execute sensitive.
     */
    public void sensitive()
    {
        checkPermission(sensitivePermission);
        print();
    }

    /**
     * Will display a message from Larry. You must be
     * careful about who is allowed to do this
     * because messages from Larry may have extra impact.
     */

```



```

* Both larry and dave have permission to execute act.
*/
public void act(String message)
{
    MyPermission p = new MyPermission("act." + message);
    checkPermission(p);
    System.out.println("Larry says: " + message);
}

/**
 * display secret key
 * No permission check is made; anyone can execute print.
 */
private void print()
{
    System.out.println(secret);
}

/**
 * Display "Hello"
 * This method invokes doPrivileged, which makes the method run
 * under definer's rights. So, this method runs under Larry's
 * rights, so anyone can execute hello. Only Larry can execute hello
 */
public void hello()
{
    AccessController.doPrivileged(new PrivilegedAction() {
        public Object run() { act("hello"); return null; }
    });
}

/**
 * If a security manager is installed ask it to check permission
 * otherwise use the AccessController directly
 */
void checkPermission(Permission permission)
{
    SecurityManager sm = System.getSecurityManager();
    sm.checkPermission(permission);
}
}

```

11.2.2.1.4 Enabling or Disabling Permissions

Once you have created a row that defines a permission, you can disable it so that it no longer applies. However, if you decide that you want the row action again, then you can enable the row. You can delete the row from the table if you believe that it will never be used again. To delete, you must first disable the row. If you do not disable the row, then the deletion will not occur.

To disable rows, you can use either of the following methods:

- `revoke_permission()`

This method accepts parameters similar to the `grant()` and `restrict()` methods. It searches the entire policy table for all rows that match the parameters provided.

- `disable_permission()`

This method disables only a single row within the policy table. To do this, it accepts the policy table key as parameter. This key is also necessary to enable or

delete a permission. To retrieve the permission key number, perform one of the following:

- Save the key when it is returned on the grant or limit calls. If you do not foresee a need to ever enable or disable the permission, then you can use the grant and limit calls that do not return the permission number.
- Look up `DBA_JAVA_POLICY` or `USER_JAVA_POLICY` for the appropriate permission key number.

You can disable permissions using `DBMS_JAVA`, as follows:

```
procedure revoke_permission (grantee varchar2, permission_type varchar2,  
permission_name varchar2, permission_action varchar2)
```

```
procedure disable_permission (key number)
```

You can disable permissions using Java, as follows:

```
void oracle.aurora.rdbms.security.PolicyTableManager.revoke (java.lang.String  
grantee, java.lang.String permission_type,  
java.lang.String permission_name, java.lang.String permission_action_type);
```

```
void oracle.aurora.rdbms.security.PolicyTableManager.disable (long key);
```

You can enable permissions using `DBMS_JAVA`, as follows:

```
procedure enable_permission (key number)
```

You can enable permissions using Java, as follows:

```
void oracle.aurora.rdbms.security.PolicyTableManager.enable (long key);
```

You can delete permissions using `DBMS_JAVA`, as follows:

```
procedure delete_permission (key number)
```

You can delete permissions using Java, as follows:

```
void oracle.aurora.rdbms.security.PolicyTableManager.delete (long key);
```

11.2.2.1.5 About Permission Types

Whenever you want to grant or limit a permission, you must provide the permission type. The permission types with which you control access are the following:

- Java 2 permission types
- Oracle-specific permission types
- User-defined permission types that extend `java.security.Permission`

[Table 11-1](#) lists the installed permission types.

Table 11-1 Predefined Permissions

Type	Permissions
Java 2	<ul style="list-style-type: none"> java.util.PropertyPermission java.io.SerializablePermission java.io.FilePermission java.net.NetPermission java.net.SocketPermission java.lang.RuntimePermission java.lang.reflect.ReflectPermission java.security.SecurityPermission
Oracle specific	<ul style="list-style-type: none"> oracle.aurora.rdbms.security.PolicyTablePermission oracle.aurora.security.JServerPermission

 **Note:**

SYS is granted permission to load libraries that come with Oracle Database. However, Oracle JVM does not support other users loading libraries, because loading C libraries within the database is insecure. As a result, you are not allowed to grant `RuntimePermission` for `loadLibrary.*`.

The Oracle-specific permissions are:

- oracle.aurora.rdbms.security.PolicyTablePermission

This permission controls who can update the policy table. Once granted the right to update the policy table for a certain permission type, you can control the access to few resources.

After the initialization of Oracle JVM, only the `JAVA_ADMIN` role can grant administrative rights for the policy table through `PolicyTablePermission`. Once it grants this right to other users, these users can, in turn, update the policy table with their own grant and limitation permissions.

To grant policy table updates, you can use the `grant_policy_permission()` method, which is in the `DBMS_JAVA` package. Once you have updated the table, you can view either the `DBA_JAVA_POLICY` or `USER_JAVA_POLICY` view to see who has been granted permissions.

- oracle.aurora.security.JServerPermission

This permission is used to grant and limit access to Oracle JVM resources. The `JServerPermission` extends `BasicPermission`. The following table lists the permission names for which `JServerPermission` grants access:

Permission Name	Description
<code>LoadClassInPackage.package_name</code>	Grants the ability to load a class within the specified package
<code>Verifier</code>	Grants the ability to turn the bytecode verifier on or off

Permission Name	Description
Debug	Grants the ability for debuggers to connect to a session
JRIExtensions	Grants the use of MEMSTAT
Memory.Call	Grants rights to call certain methods in oracle.aurora.vm.OracleRuntime on call settings
Memory.Stack	Grants rights to call certain methods in oracle.aurora.vm.OracleRuntime on stack settings
Memory.SGASIntern	Grants rights to call certain methods in oracle.aurora.vm.OracleRuntime on SGA settings
Memory.GC	Grants rights to call certain methods in oracle.aurora.vm.OracleRuntime on garbage collector settings

Table 11-2 JServerPermission Description

Grantee	Permission Type	Permission Name	Permission Granted or Restricted	Action
JAVADEBUGPRIV	SYS:oracle.aurora.security.JServerPermission	Debug	Granted	null
SYS	SYS:oracle.aurora.security.JServerPermission	*	Granted	null
SYS	SYS:oracle.aurora.security.JServerPermission	LoadClassInPackage.java.*	Granted	null
SYS	SYS:oracle.aurora.security.JServerPermission	LoadClassInPackage.oracle.aurora.*	Granted	null
SYS	SYS:oracle.aurora.security.JServerPermission	LoadClassInPackage.oracle.jdbc.*	Granted	null
PUBLIC	SYS:oracle.aurora.security.JServerPermission	LoadClassInPackage.*	Granted	null
PUBLIC	SYS:oracle.aurora.security.JServerPermission	LoadClassInPackage.java.*	Restricted	null
PUBLIC	SYS:oracle.aurora.security.JServerPermission	LoadClassInPackage.oracle.aurora.*	Restricted	null
PUBLIC	SYS:oracle.aurora.security.JServerPermission	LoadClassInPackage.oracle.jdbc.*	Restricted	null
JAVA_DEPLOY	SYS:oracle.aurora.security.JServerPermission	LoadClassInPackage.oracle.aurora.deploy.*	Granted	null
JAVA_DEPLOY	SYS:oracle.aurora.security.JServerPermission	Deploy	Granted	null

11.2.2.1.6 About Initial Permission Grants

When you first initialize Oracle JVM, several roles are populated with certain permission grants. The following tables show these roles and their initial Permissions:

- [Table 11-3](#)
- [Table 11-4](#)
- [Table 11-5](#)
- [Table 11-6](#)
- [Table 11-7](#)

The `JAVA_ADMIN` role is given access to modify the policy table for all permissions. All DBAs, including `SYS`, are granted `JAVA_ADMIN`. Full administrative rights to update the policy table are granted for the permissions listed in [Table 11-1](#). In addition to the `JAVA_ADMIN` permissions, `SYS` is granted some additional permissions that are needed to support the standard JDK functionality and Oracle JVM specifics.

[Table 11-3](#) lists some of the additional permissions granted to `SYS`.

Table 11-3 `SYS` Initial Permissions

Permission Type	Permission Name	Action
oracle.aurora.rdbms.security. PolicyTablePermission	oracle.aurora.rdbms.secu rity.PolicyTablePermissi on#*	null
oracle.aurora.security.JServerPermission	*	null
java.net.NetPermission	*	null
java.security.SecurityPermission	*	null
java.util.PropertyPermission	*	write
java.lang.reflect.ReflectPermission	*	null
java.lang.RuntimePermission	*	null
java.lang.RuntimePermission	loadLibrary.xaNative	null
java.lang.RuntimePermission	loadLibrary.corejava	null
java.lang.RuntimePermission	loadLibrary.corejava_d	null

[Table 11-4](#) lists permissions initially granted or restricted to all users.

Table 11-4 `PUBLIC` Default Permissions

Permission Type	Permission Name	Permission Granted or Restricted	Action
oracle.aurora.rdbms.secur ity. PolicyTablePermission	java.lang.RuntimePermission#loadLibrary.*	Restricted	null

Table 11-4 (Cont.) PUBLIC Default Permissions

Permission Type	Permission Name	Permission Granted or Restricted	Action
java.util.PropertyPermission	*	Granted	read
java.util.PropertyPermission	user.language	Granted	write
java.util.PropertyPermission	oracle.net.tns_admin	Granted	write
java.lang.RuntimePermission	exitVM	Granted	null
java.lang.RuntimePermission	createSecurityManager	Granted	null
java.lang.RuntimePermission	modifyThread	Granted	null
java.lang.RuntimePermission	modifyThreadGroup	Granted	null
java.lang.RuntimePermission	getenv.ORACLE_HOME	Granted	null
java.lang.RuntimePermission	getenv.TNS_ADMIN	Granted	null
java.lang.RuntimePermission	preferences	Granted	null
java.lang.RuntimePermission	loadLibrary.*	Restricted	null
oracle.aurora.security.JServerPermission	LoadClassInPackage.* except for LoadClassInPackage.java.*, LoadClassInPackage.oracle.aurora.*, and LoadClassInPackage.oracle.jdbc.*	Granted	null

Table 11-5 lists permissions initially granted to the JAVAUSERPRIV role.

Table 11-5 JAVAUSERPRIV Permissions

Permission Type	Permission Name	Action
java.net.SocketPermission	*	connect, resolve
java.io.FilePermission	<<ALL FILES>>	read
java.lang.RuntimePermission	stopThread	null
java.lang.RuntimePermission	getProtectionDomain	null
java.lang.RuntimePermission	accessClassInPackage.*	null
java.lang.RuntimePermission	defineClassInPackage.*	null

Table 11-6 lists permissions initially granted to the JAVASYSPRIV role.

Table 11-6 JAVASYSPRIV Permissions

Permission Type	Permission Name	Action
java.io.SerializablePermission	*	no applicable action
java.io.FilePermission	<<ALL FILES>>	read, write, execute, delete
java.net.SocketPermission	*	accept, connect, listen, resolve
java.sql.SQLPermission	setLog	null
java.lang.RuntimePermission	createClassLoader	null
java.lang.RuntimePermission	getClassLoader	null
java.lang.RuntimePermission	setContextClassLoader	null
java.lang.RuntimePermission	setFactory	null
java.lang.RuntimePermission	setIO	null
java.lang.RuntimePermission	setFileDescriptor	null
java.lang.RuntimePermission	readFileDescriptor	null
java.lang.RuntimePermission	writeFileDescriptor	null

Table 11-7 lists permissions initially granted to the JVADEBUGPRIV role.

Table 11-7 JVADEBUGPRIV Permissions

Permission Type	Permission Name	Action
oracle.aurora.security.JServerPermission	Debug	null

11.2.2.2 Assigning General Permission Definition to Roles

In Oracle8i Database release 8.1.5, Oracle JVM security was controlled by granting the JAVASYSPRIV, JAVAUSERPRIV, or JVADEBUGPRIV role to schemas. In Oracle Database 12c Release 1 (12.1), these roles still exist as permission groups. You can set up and define your own collection of permissions. Once defined, you can grant any collection of permissions to any user or role. That user will then have the same permissions that exist within the role. In addition, if you need additional permissions, then you can add individual permissions to either your specified user or role. Permissions defined within the policy table have a cumulative effect.

Note:

The ability to write to properties, granted through the write action on PropertyPermission, is no longer granted to all users. Instead, you must have either JAVA_ADMIN grant this permission to you or you can receive it by being granted the JAVASYSPRIV role.

The following example gives Larry and Dave the following permissions:

- Larry receives JAVASYSPRIV permissions.
- Dave receives JAVADEBUGPRIV permissions and the ability to read and write all files on the system.

```
REM Granting Larry the same permissions as those existing within JAVASYSPRIV
grant javasyspriv to larry;
```

```
REM Granting Dave the ability to debug
grant javadebugpriv to dave;
```

```
commit;
```

```
REM I also want Dave to be able to read and write all files on the system
call dbms_java.grant_permission('DAVE', 'SYS:java.io.FilePermission',
 '<ALL FILES>', 'read,write', null);
```

Related Topics

- [Fine-Grain Definition for Each Permission](#)

11.2.3 Debugging Permissions

A debug role, JAVADEBUGPRIV, was created to grant permissions for running the debugger. The permissions assigned to this role are listed in [Table 11-7](#). To receive permission to call the debug agent, the caller must have been granted JAVADEBUGPRIV or the debug JServerPermission as follows:

```
REM Granting Dave the ability to debug
grant javadebugpriv to dave;
```

```
REM Larry grants himself permission to start the debug agent.
call dbms_java.grant_permission(
 'LARRY', 'oracle.aurora.security.JServerPermission', 'Debug', null);
```

Although a debugger provides extensive access to both code and data on the server, its use should be limited to development environments.

11.2.4 Permission for Loading Classes

To load classes, you must have the following permission:

```
JServerPermission("LoadClassInPackage." + class_name)
```

where, *class_name* is the fully qualified name of the class that you are loading.

This excludes loading into System packages or replacing any System classes. Even if you are granted permission to load a System class, Oracle Database prevents you from performing the load. System classes are classes that are installed by Oracle Database using the CREATE JAVA SYSTEM statement. The following error is thrown if you try to replace a System class:

```
ORA-01031 "Insufficient privileges"
```

The following describes what each user can do after database installation:

- SYS can load any class except for System classes.
- Any user can load classes in its own schema that do not start with the following patterns: java.*, oracle.aurora.*, and oracle.jdbc.*. If the user wants to load

such classes into another schema, then it must be granted the `JServerPermission(LoadClassInPackage.class)` permission.

The following example shows how to grant HR permission to load classes into the `oracle.aurora.tools.*` package:

```
dbms_java.grant_permission('HR','SYS:oracle.aurora.security.JServerPermission','LoadClassInPackage.oracle.aurora.tools.*',null);
```

11.2.5 Customizing the Default java.security Resource

If you want to add a security provider or change the order of the security providers listed in the default `java.security` resource, then you can create an alternate resource and add it to the Database. This change affects all new Oracle JVM sessions that start after the resource is loaded. Perform the following steps to configure the default `java.security` resource:

1. Create the following file:

```
$ORACLE_HOME/javavm/lib/security/java.security.alt
```

2. Use the following command to copy the contents of the file `$ORACLE_HOME/javavm/lib/security/java.security` into the file created in step 1:

```
cp $ORACLE_HOME/javavm/lib/security/java.security $ORACLE_HOME/javavm/lib/security/java.security.alt
```

3. Edit the `$ORACLE_HOME/javavm/lib/security/java.security.alt` file and make the necessary changes as necessary.

Caution:

If you make a mistake in specifying the order of the service providers or defined devices, then some features may become unusable.

4. Use the following commands to load the `java.security.alt` file:

Note:

You must be able to login as `SYS` to load the `lib/security/java.security.alt` file.

```
cd $ORACLE_HOME/javavm
loadjava -u sys/<sys_pwd> -v -g public lib/security/java.security.alt
```

This security setting affects every future Oracle JVM session started from the Database. However, the changes in the security settings are not in effect for the loading session.

 **Caution:**

You must have knowledge about the security parameters before configuring them. Incorrect settings can lead to abnormal operations.

 **See Also:**

<http://docs.oracle.com/javase/7/docs/technotes/guides/security/index.html> for more information about this security setting

Example 11-4 Creating or Replacing Java System

You must now perform a Create or Replace Java System, for `java.security.alt` to provide a different set of security parameters to the OJVM. Before this, all system sessions should be re-started using:

```
sqlplus / as sysdba
shutdown
```

```
sqlplus / as sysdba
startup
```

Create Java System is performed in the following way:

```
sqlplus / as sysdba
create or replace java system
```

For Linux.X64 databases, the Create Java System will not work. In that case, use the following command:

```
sqlplus / as sysdba
call javavm_sys.rehotload();
```

Example 11-5 Restoring the Security Settings

You can restore the original security settings in either of the two following ways:

- Use the following commands:

```
cd $ORACLE_HOME/javavm
dropjava -u sys/<sys_pwd> -v lib/security/java.security.alt
```

- Use the following commands:

```
sqlplus sys/<sys_pwd> as sysdba
SQL> drop java resource "lib/security/java.security.alt";
```

11.3 Database Authentication Mechanisms Available with Oracle JVM

The following database authentication mechanisms are available with Oracle JVM:

- Password authentication

- Strong authentication
- Proxy authentication
- Single sign-on

11.4 Secure Use of Runtime.exec Functionality in Oracle Database

This section is intended for DBAs and security administrators, and provides guidelines for secure use of the Java SE functionality `Runtime.exec` in Java applications running inside Oracle Database. The `java.lang.Runtime.exec` methods, found in Java SE libraries and supported by Java Virtual Machine (Java VM) since release 9, span a new operating system (OS) process and execute the specified command and arguments in the new process. If a `SecurityManager` is present, which is always the case for Java VM running in the database, then a security check for file execution permissions on relevant path names is performed before the new OS process starts. If you are a DBA or a security administrator, then you are responsible for granting the appropriate file read, write, and execute permissions selectively to the database users, who are authorized to run server-side OS commands. In addition, Oracle strongly recommends that the `dbms_java.set_runtime_exec_credentials` procedure is used to control OS user identities of spawned commands as described in the following sections.

By design, the `Runtime.exec` and the related functionality of the `java.lang.ProcessBuilder` and `java.lang.Process` classes provide no control over the identity of the user associated with the newly created process. In most Java implementations, including the default behavior of Java VM, the forked process runs with the identity of the parent process, which is the Oracle OS user in Oracle Database. For security reasons, it is advisable to run the processes forked by the `Runtime.exec` functionality with OS identity granted lesser rights. The `dbms_java.set_runtime_exec_credentials` procedure provides a mechanism to bind a specified database user/schema to a specific OS account. If you are a DBA, then you should bind database users issuing `Runtime.exec` calls to OS accounts with the least possible power. The following call associates database user/schema `DBUSER` with an OS `osuser` account:

```
dbms_java.set_runtime_exec_credentials('DBUSER', 'osuser', 'ospass');
```

As a result, the OS process spawned to run the `Runtime.exec` commands issued by `DBUSER` runs with the identity of `osuser`. You must be the `SYS` user to use `set_runtime_exec_credentials` procedure.

Related Topics

- [set_runtime_exec_credentials](#)

12

Native Oracle JVM Support for JNDI

This chapter describes Oracle JVM support for Java Naming and Directory Interface (JNDI). This chapter contains the following sections:

- [Overview of Oracle JVM Support for JNDI](#)
- [Requirements for Oracle JVM Support for JNDI](#)
- [OJDS Command-Line Tools](#)
- [OJDS APIs and Classes](#)

12.1 Overview of Oracle JVM Support for JNDI

Native Oracle JVM support for JNDI enables you to bind Oracle data source objects, which contain specific database connection information, by a name in a directory structure. You can use this name to retrieve the particular connection information to establish a connection within an application. You can also change the database connection properties and the actual source database without changing the application by changing only the associated object to which a specific name is resolved. This feature also provides a general purpose directory service for storing objects and object references.

The Oracle Java Directory Service (OJDS) package, `oracle.aurora.jndi.ojds` provides the APIs for implementing JNDI support.

Related Topics

- [OJDS APIs and Classes](#)

12.2 Requirements for Oracle JVM Support for JNDI

This section describes the implementation requirements for JNDI support in the Oracle JVM. This section is divided into the following sections:

- [Namespace](#)
- [Oracle Java Directory Service JNDI Name Space Provider](#)
- [Namespace Browser](#)

12.2.1 Namespace

The namespace is represented similarly as in the typical Unix File System structure. The root directory and the directory separator are represented by the slash symbol (/). The root directory is owned by `sys` and only `sys` can create new subdirectories under it.

The following two directories (`DirContexts`) are created during the installation process of OJDS:

- `/public` directory

The `/public` directory is a public area for testing and any user can bind, delete, or lookup objects in this directory.

- `/etc` directory

The `/etc` directory is an area for the deployment of all production type objects that a client may need and is protected from any update or removal. The `/etc` directory is writable only by the `SYS` user, but is readable by all users.

12.2.1.1 Object permissions

You can assign permissions to the objects stored in the directory structure. These permissions are a union of the following permissions:

- Read
- Write
- Execute

The following table describes the permissions that you can assign to the objects stored in the directory structure:

Action	Parent Context Permissions	Child (obj/ctx) Permissions
bind	Write	NA
unbind	Write	Write
createSubcontext	Write	NA
getAttributes	Read	Read
rebind	Write	Write
destroySub context	Write	Write
list	Read	Read
listBindings	Read	Read
lookup	Read	Read
lookupLink	Read	Read
rename (target)	Write	Write (if exists)
rename (source)	Read	Read



Note:

All parent contexts must have Execute permission for operations to succeed.

12.2.1.2 Persistent Storage Tables, Indexes, and Sequences

The database tables owned by `OJVM SYS` store the following details for each object:

- Namespace metadata
- Bound names

- Attributes
- Permissions
- Stored object representations

12.2.1.3 Initial Contexts and Permissions

The following table shows the contexts that are created by default at the time of installation:

Name	Owner	Read	Write	Execute
/	SYS	PUBLIC	SYS	PUBLIC
/public	SYS	PUBLIC	PUBLIC	PUBLIC
/etc	SYS	PUBLIC	SYS	PUBLIC

12.2.1.4 Object and Context Default Permissions

When a context is created or an object is bound to the OJDS, then the Read and Execute permissions are granted to the user or schema that creates the context.

12.2.2 Oracle Java Directory Service JNDI Name Space Provider

This section describes the following Oracle Java Directory Service concepts:

- [Directory Context](#)
- [StateFactories](#)
- [ObjectFactories](#)
- [OJDS URL Support](#)
- [Client classpath](#)

12.2.2.1 Directory Context

The Oracle Java Directory Service (OJDS) must implement the interface as specified by the `javax.naming.directory.DirContext` context. The `javax.naming.directory.DirContext` context, the `oracle.aurora.jndi.ojds.OjdsServerContext` context, and the `oracle.aurora.jndi.ojds.OjdsClientContext` context provide the methods for examining and updating attributes associated with the objects, and enables searches of the directory for server-side and client-side executions respectively.

The following table describes the JNDI properties that you can use for creating a context or using a context:

Package Name	Description
<code>java.naming.factory.initial</code>	Specifies what class to use to create initial contexts for the application. The <code>oracle.aurora.jndi.ojds</code> package defines the <code>oracle.aurora.jndi.ojds.OjdsInitialContextFactory</code> for use with this property to create <code>InitialDirContext</code> .

Package Name	Description
<code>java.naming.security.principal</code>	Specifies the user ID for creating a database connection. You must specify the value for this property.
<code>java.naming.security.credentials</code>	Specifies the password for creating a database connection. You must specify the value for this property.
<code>java.naming.provider.url</code>	Specifies the connection URL for creating a database connection. This property is optional.
<code>java.naming.factory.url.pkgs</code>	Is a colon separated list of URL handlers for specific JNDI implementations. The <code>oracle.aurora.jndi.ojds.OjdsURLContextFactory</code> class returns a context based on an OJDS URL.

12.2.2.2 StateFactories

A `StateFactory` transforms a Java object into an object that can be stored in the implementing JNDI provider. The OJDS converts all the objects to bind to a serialized object. OJDS follows the specifications of the `java.io.Serializable` interface and the Java Object Serialization Specification for this conversion. Once serialized, the object is stored in the OJDS persistent store. No external `StateFactories` are supported for OJDS.

12.2.2.3 ObjectFactories

An `ObjectFactory` takes objects stored in the implementing JNDI provider and converts them to back into Java objects. The OJDS does not support external `ObjectFactories`. The serialized objects are created from their binary form that are retrieved from the OJDS persistent store. After an object is deserialized, OJDS handles the object in one of the following ways:

- If the object is a `Context`, then the `connection` and the `env` fields are set and a `DirContext` is returned.
- If the object is a `javax.naming.Reference`, then you can use the `DirectoryManager.getObjectInstance` method to create the object.
- If the object is neither a `Context` nor a `javax.naming.Reference`, then the object is returned as it is to the user.

The retrieved bytes specifying an object must conform to the `java.io.Serializable` interface standards. If the class implementing the object changes on the client, then the deserialization of the object can fail. So, you must be careful to maintain compatibility between the object bytes and the class or object stream deserializing the object bytes.

12.2.2.4 OJDS URL Support

The OJDS supports a URL specified in the following format:

```
ojds://jdbc_connection_url/path.../object
```

In the preceding syntax:

- `jdbc_connection_url` is one of the supported JDBC connection URLs. You must specify the `jdbc_connection_url` in the URL to connect to the directory.

 **Note:**

The OJDS provider supports both the thin and OCI URLs for a JDK-based external client. For example, you can use the following URLs for thin driver and OCI driver respectively:

```
thin:localhost:5521:mysid
oci:22.133.242:5521:mysid
```

However, OJDS URL support in the server is only for thin connection type. You must set a value for `Context.SECURITY_PRINCIPAL` and `Context.SECURITY_CREDENTIALS` to complete the URL connection.

- `path` is a slash¹-separated list similar to a Unix type file system. This represents nodes in the Directory tree.
- `object` is the actual terminal object name in the context. If the object is omitted, then the path terminates in a slash (/). In such a case, a `DirContext` is returned representing this path as the root.

Example

The following code snippet shows how to look up for the object `myobj` of type `MyObj` in the directory `/one/two` using the OCI driver connected as user `HR`:

```
import javax.naming.*;
.
.
.
Hashtable env = new Hashtable();
env.put("java.naming.security.principal", "HR");
@ env.put("java.naming.security.credentials", "<password>");
MyObj obj = (MyObj)(new InitialDirContext(env)).lookup(ojds://
oci:host1:5521:mysid/one/two/myobj");
```

12.2.2.5 Client classpath

You must add the `$ORACLE_HOME/jdbc/lib/ojdbc6.jar` and `$ORACLE_HOME/javavm/lib/aurora.zip` jar files to the classpath for a JDK client to use the OJDS.

12.2.3 Namespace Browser

The namespace browser enables browsing permissions and properties of objects stored in the OJDS. The existing `ojvmjava` utility is enhanced to support the operations as described in the following table:

Command Name	Description
<code>ls</code>	Lists the contents of a context similar to Unix <code>ls</code> command.

¹ The slash symbol (/)

Command Name	Description
rm	Removes the context or an object.
mkdir	Creates a context in the OJDS.
chown	Changes the owner of the given context, object, and so on.
chmod	Changes rights on objects or contexts.
cd	Changes the working context.
pwd	Lists the current working context.
ln	Refers to the same object by using different names, similar to a symbolic link in Unix.
mv	Changes or rebinds old names of a context (or object), to a new name.
bind	Binds an object reference or naming context into the JNDI namespace.
bindds	Binds a Data Source object to a given context.
bindurl	Binds a URL object to the given context.

Related Topics

- [The ojvmjava Tool](#)

12.3 OJDS Command-Line Tools

The enhanced `ojvmjava` commands enable you to manipulate and browse the OJDS. This section describes the following commands:

- [ls Command](#)
- [cd Command](#)
- [pwd Command](#)
- [chown Command](#)
- [mkdir Command](#)
- [rm Command](#)
- [ln Command](#)
- [mv Command](#)
- [chmod Command](#)
- [bind Command](#)
- [bindds Command](#)
- [bindurl Command](#)

12.3.1 ls Command

The `ls` command displays the contents of a context.

Syntax

```
ls [options] [context1] [context2] [obj|context]...
```

Options

The following table describes the `ls` command options:

Option	Description
Context obj	Specifies the name of the context or object to be listed
-l	Shows contents in long format including name, creation time, owner, rights, and so on. Shows the class of an object.
dir	Shows only contexts, similar to the Unix <code>ls -d</code> command
ldir	Shows contents in long format like the <code>-l</code> command, but ignores bound objects, similar to Unix <code>-ld</code>
R	Recursively lists though child contexts

Example

The following command displays contents of the root Context in short format:

```
$ ls /
etc/      public/
```

The following command displays contents of the root Context in long format:

```
$ ls -l
Read    Write  Exec   Owner  Date    Time    Type    Name
PUBLIC  SYS    PUBLIC SYS    Dec 14  14:59   Context etc
PUBLIC  PUBLIC PUBLIC  SYS    Dec 14  14:59   Context public
```

12.3.2 cd Command

The `cd` command changes the working context. This command is similar to the Unix `cd` command to change directories.

Example

The following command changes the context to root Context

```
$ cd /
```

12.3.3 pwd Command

The `pwd` command lists the current working context.

Example

If the current context is `/test/alpha`, then the output of the `pwd` command is the following:

```
$ pwd
/test/alpha/
```

12.3.4 chown Command

The `chown` command changes the ownership of the context or the object.



Note:

You can change ownership of a context or an object only if you are the `sys` user.

Syntax

```
chown [options] {user | role} <object name>
```

Options

The following table describes the `chown` command options:

Option	Description
User role	Specifies the name of the user or role to become the owner
<object name>	Specifies the name of the context or object to be changed
-R	Recursively changes ownership of the following: <ul style="list-style-type: none"> Context All the subcontexts in the context All the objects that are contained in the context and subcontexts

Example

The following command makes `HR` the owner of the `/alpha/beta/gamma` command:

```
$ chown HR /alpha/beta/gamma
```

12.3.5 mkdir Command

The `mkdir` command creates a context with the given name.



Note:

You must have the Write permission for the target context to create the new context.

Options

The following table describes the `mkdir` command options:

Option	Description
<name>	Specifies the name of the context to be created
-path -p	Creates intermediate contexts if they do not exist

Example

The following command creates a Context called `/test/alpha`, where the `/test` context exists already:

```
mkdir /test/alpha
```

The following command creates a Context called `/test/alpha/beta/gamma`, where the `/test/alpha/beta` context does not exist:

```
$ mkdir -path /test/alpha/beta/gamma
```

12.3.6 rm Command

The `rm` command is analogous to the `rm` UNIX shell command. This command removes an object or a context, including its contents.

Note:

To remove an object, you must have the Write right for the context that contains the object.

Options

The following table describes the `rm` command options:

Option	Description
<Object>	Specifies the name of the context or the object to be removed
-recurse -r	Assumes a context and removes the context and its contents recursively

Examples

The following command removes the object `/test/bank`:

```
rm /test/bank
```

The following command removes the context `/test/release3` and its contents:

```
rm -r /test/release3
```

12.3.7 ln Command

The `ln` command is analogous to the UNIX `ln` command. A link is a synonym for a context or an object. When you move a context or an object, the reference to the

context or object may become invalid. The `ln` command creates a link with the old name and makes the object accessible by both the old and the new name.

Syntax

```
ln [-symbolic | -s] <object> <link>
```

Options

The following table describes the `ln` command options:

Option	Description
<code>-s</code>	Create a soft link of <code><object></code> to <code><link></code>
<code><object></code>	Specifies the name of a context or an object
<code><link></code>	Specifies the name of the synonym to which you link a context or an object

Example

The following command preserves access to the `old` object even after the name of the object is changed to `new`:

```
$ mv old new
$ ln new old
```

12.3.8 mv Command

The `mv` command changes the name (or rebinds old names) of a context or an object to a new name.

Syntax

```
mv <old> <new>
```

Example

The following command changes the name of the context `/test/foo` to `/test/bar`:

```
$ mv /test/foo /test/bar
```

12.3.9 chmod Command

The `chmod` command is analogous to the `chmod` UNIX shell command. This command changes the rights of a user or a role on a context or an object.

Note:

You can change the rights on an object only if you are the `sys` user or the owner of the object.

Syntax

```
chmod [options] {+|-} {r|w|x} {<user> | <role>, ...} <objectname>
```

Options

The following table describes the `chmod` command options:

Option	Description
+/-rwx	Add (+) or remove (-) read, write, or execute
<user> <role>	The user or role whose rights are added or removed
<objectname>	The context or object for which rights are changed
-R	Changes rights recursively

Example

The following example changes rights for the `/alpha/beta/gamma` context to HR and NANCY:

```
$ chmod +x HR,NANCY /alpha/beta/gamma
```

Note:

The schemas are separated by only a comma.

The following example removes the Write rights of HR for the `/alpha/beta/gamma` context:

```
$ chmod -w HR /alpha/beta/gamma
```

Related Topics

- [Object permissions](#)

12.3.10 bind Command

The `bind` command binds an object reference or context into the JNDI namespace.

Syntax

```
bind <objectname> [options] [-context] [-rebind] {-class | -c <classname>}
[-factory | -f <factory>] [-location | -l <URL>][-string <type_name>
<string_value> [-string <type_name> <string_value> ...]] [-binary
<type_name> <string_value> [-binary <type_name> <string_value> ...]]
```

Options

The following table describes the `bind` command options:

Option	Description
<objectname>	Name object is to be bound to
-context	The object to be bound is a Context or InitialContext
-rebind	If the JNDI name already exists, replaces the object that it is bound to with this object
-class <classname>	Specifies the class name for the bound object
-factory <factory>	Specifies the factory class name for creating the object. JNDI uses this for creating the object.
-location <URL>	Specifies the factory location if the default location is not used. This takes a JNDI URL.
-string <type_name> <string_value>	Specifies a String reference attribute for the object by the type name and value.
-binary <type_name> <string_value>	Specifies a Binary reference attribute for the object by the type and a binary value. The given Hexidecimal string value is converted into binary.

Example

The following binds an object reference into the name space. A string and binary attribute is supplied to the reference.

```
bind /tmp/myprinter -class gen.Inkjet -factory gen.InkjetFactory -string
PRINTERNAME co2 -binary DPI 0X12C
```

12.3.11 bindds Command

This command binds a `DataSource` object in the JNDI namespace. This command binds general, XA, or pooled data sources depending on specified options.



Note:

Oracle JVM supports only kprb drivers and thin drivers.

Syntax

```
bindds <object_name> [options] [-help | -h] [-describe | -d] [-version | -v] [-dstype <datasource>]
```

```
[-host <hostname> -port <portnum> -sid <SID> -driver <driver_type>] [-url <db_url>]
```

```
[-g | -grant {<user> | <role>} [, {<user> | <role>}]...] [-recursiveGrant | -rg {<user> | <role>}]
```

```
[, {<user> | <role>}]... [-rebind] [-user | -u <user>]
```

Options

The following table describes the `bindds` command options:

Option	Description
<objectname>	Specifies the name to which the object is to be bound
-help	Specifies the help message
-describe	Summarizes the tools operation
-version	Specifies the version number
-dstype <type>	Specifies the data source type from one of the following types: <ul style="list-style-type: none"> • None for OracleDataSource • xa for OracleXADataSource • pool for OracleConnectionPoolDataSource
-host <hostname> -port <portnum> -sid <SID> -driver <drv_type>	Specify the location of the database and driver type for the connection to the database. You can alternatively specify this information in a URL format within the -url option. The default value for the -sid option is ORCL. The -driver option can have the following values: thin, oci, or kprb.
-url <db_url>	This JDBC URL specifies the location of the database.
-grant <user role>, <user role>...	Grants Read and Execute rights to the sequence of <user> and <role> names. When rebinding, replace the existing users or roles that have read or execute rights with the <user> and <role> names.
-recursiveGrant <user role>, <user role>...	Recursively grants Read and Execute permission to the designated object and all the contexts in which the object exists. If the context has a permission level of SYS, the grant for that context is ignored.
-rebind	If the DataSource object already exists, then you must specify this option to overwrite the existing data source with this new object. Otherwise, no bind occurs for this option.
-user <user>	Specifies the user name for connecting to the database. Stores the user name within the DataSource object. If you do not supply a user name within the JNDI Context while creating the database connection, then this user name is used.

Example

The following example binds the ds1 data source into the namespace:

```
bindds /test/ds1 -host localhost -port 1522 -sid orcl -driver thin
bindds /test/ds1 -url jdbc:oracle:thin:@localhost:1522:orcl
```

The example uses the JDBC thin driver with a general data source, that is, OracleDataSource.

12.3.12 bindurl Command

The bindurl command binds a URL object in the namespace.

Options

The following table describes the bindurl command options:

Option	Description
<objectname>	Specifies the name of the object to be bound
-help	Specifies the help message
-describe	Summarizes the tools operations
-version	Prints the version of the bindurl command
-rebind	If the JNDI name already exists, then you must specify this option to overwrite the existing JNDI name with this new object. Otherwise, no bind occurs for this option.
-grant <user role>, <user role>...	Grants Read and Execute rights to the sequence of <user> and <role> names. When rebinding, you can replace the existing users or roles that have read or execute rights with the <user> and <role> names.
-recursiveGrant <user role>, <user role>...	Recursively grants Read and Execute permission to the designated object and to all contexts within which the object exists. If the context has a permission level of SYS, then the grant for that context is ignored.

Example

The following example binds the URL string <http://www.oracle.com> to a URL reference `/test/myURL` within the namespace:

```
bindurl /test/myURL http://www.oracle.com -rebind
```

The `-rebind` option is used to make sure that if the `/test/myURL` reference previously exists, then it is rebound with the string <http://www.oracle.com>.

12.4 OJDS APIs and Classes

This section describes the following OJDS APIs and classes:

- [oracle.aurora.jndi.ojds.OjdsClientContext](#)
- [oracle.aurora.jndi.ojds.OjdsServerContext](#)
- [oracle.aurora.jndi.ojds.OjdsInitialContextFactory](#)
- [oracle.aurora.jndi.ojds.OjdsURLContextFactory](#)
- [oracle.aurora.jndi.ojds.OjdsURLContext](#)

12.4.1 oracle.aurora.jndi.ojds.OjdsClientContext

This class implements the `javax.naming.directory.DirContext` interface. It establishes connection with the database and performs all functions required to support the OJDS. It supports all the methods described in `[DirContext]` except the following methods:

- `getSchema`
- `getSchemaClassDefintion`
- `modifyAttributes`

- search

This class is created automatically when an `InitialDirContext` is created on a JAVA JDK based client. It provides the communication and object transport between the client application and the OJDS.

You must set the following JNDI properties to specific values to complete a connection:

- `java.naming.factory.initial` to `oracle.aurora.jndi.ojds.OjdsInitialContextFactory`
- `java.naming.security.principal` to the name of the connection schema
- `java.naming.security.credentials` to the schema password
- `java.naming.provider.url` to a valid OJDS URL

You can set these properties as shown in the following code snippet:

```
Hashtable env = new Hashtable();
env.put("java.naming.factory.initial",
"oracle.aurora.jndi.ojds.OjdsInitialContextFactory");
env.put(Context.SECURITY_PRINCIPAL, "HR");
env.put(Context.SECURITY_CREDENTIALS, "<password>");
env.put(Context.PROVIDER_URL, "ojds://thin:localhost:5521:j3");
```

12.4.2 oracle.aurora.jndi.ojds.OjdsServerContext

This class implements the `javax.naming.directory.DirContext` interface. It uses the internal database connection to communicate with the OJDS persistent store. It supports all the methods described in `[DirContext]` except for the following methods:

- `getSchema`
- `getSchemaClassDefintion`
- `modifyAttributes`
- `search`

This class is created automatically when an `InitialDirContext` is created in a database resident application. It uses the database internal JDBC driver to communicate with the OJDS persistent store.

The four environment properties for the `OjdsClientContext` are ignored for `OjdsServerContext` because the application runs as the `login` schema. The connection is made with the `kprb [JDBC]` internal driver. If the Java stored procedure requires access outside the server, then you must use the `OJDS URLContext` as the value of the `java.naming.provider.url` property.

Related Topics

- [oracle.aurora.jndi.ojds.OjdsInitialContextFactory](#)

12.4.3 oracle.aurora.jndi.ojds.OjdsInitialContextFactory

This class implements the `javax.naming.spi.InitialContextFactory` interface. The JNDI `InitialContext` or `InitialDriContext` classes create either an `OjdsClientContext` or an `OjdsServerContext` depending on the execution environment.

12.4.4 oracle.aurora.jndi.ojds.OjdsURLContextFactory

This class supports OJDS style URLs. Depending on the method provided to the URL, this method can return a `DirContext` or an instance of an object stored in the OJDS.

12.4.5 oracle.aurora.jndi.ojds.OjdsURLContext

This class is an extension of the `oracle.aurora.jndi.ojds.OjdsClientContext`. It supports extraction of connection information from an OJDS URL and making a connection to the OJDS. It supports the same interfaces as `oracle.aurora.jndi.ojds.OjdsClientContext` class.

You must set the following parameters to use the `OjdsURLContext` class:

- `javax.naming.security.principal` to the connection schema
- `javax.naming.security.credentials` to the password of the connection schema
- `javax.naming.factory.initial` to `oracle.aurora.jndi.ojds.OjdsInitialContextFactory`

You can set these properties as shown in the following code snippet:

```
Hashtable env = new Hashtable();
env.put("java.naming.factory.initial",
"oracle.aurora.jndi.ojds.OjdsInitialContextFactory");
env.put(Context.SECURITY_PRINCIPAL, "HR");
env.put(Context.SECURITY_CREDENTIALS, "<password>");
DirContext dir =
(new InitialContext(env)).lookup("ojds://thin:localhost:5521:j3/public./mydir");
```

13

Schema Objects and Oracle JVM Utilities

This chapter describes the schema objects that you use in Oracle Database Java environment and Oracle JVM utilities. You run these utilities from a UNIX shell or from the Microsoft Windows DOS prompt.

 **Note:**

All names supplied to these tools are case-sensitive. As a result, the schema, user name, and password should not be changed to uppercase.

This chapter contains the following sections:

- [Overview of Schema Objects](#)
- [What and When to Load](#)
- [Resolution of Schema Objects](#)
- [Compilation of Schema Objects](#)
- [The ojvmtc Tool](#)
- [The loadjava Tool](#)
- [The dropjava Tool](#)
- [The ojvmjava Tool](#)

13.1 Overview of Schema Objects

Unlike conventional Java virtual machine (JVM), which compiles and loads Java files, Oracle JVM compiles and loads schema objects. The following kinds of Java schema objects are loaded:

- Java class schema objects, which correspond to Java class files.
- Java source schema objects, which correspond to Java source files.
- Java resource schema objects, which correspond to Java resource files.

To ensure that a class file can be run by Oracle JVM, you must use the `loadjava` tool to create a Java class schema object from the class file or the source file and load it into a schema. To make a resource file accessible to Oracle JVM, you must use the `loadjava` tool to create and load a Java resource schema object from the resource file.

The `dropjava` tool deletes schema objects that correspond to Java files. You should always use the `dropjava` tool to delete a Java schema object that was created with the `loadjava` tool. Dropping schema objects using SQL data definition language (DDL) commands will not update auxiliary data maintained by the `loadjava` tool and the `dropjava` tool.

13.2 What and When to Load

You must load resource files using the `loadjava` tool. If you create `.class` files outside the database with a conventional compiler, then you must load them with the `loadjava` tool. The alternative to loading class files is to load source files and let Oracle Database compile and manage the resulting class schema objects. In Oracle Database 12c Release 1 (12.1), the most productive approach is to compile and debug most of your code outside the database, and then load the `.class` files. For a particular Java class, you can load either its `.class` file or the corresponding `.java` file, but not both.

The `loadjava` tool accepts Java Archive (JAR) files that contain either source and resource files or class and resource files. When you pass a JAR or ZIP file to the `loadjava` tool, by default, it opens the archive and loads its members individually.



Note:

When you load the contents of a JAR into the database, you have the option of creating a database object representing the JAR itself.

A file, whose content has not changed since the last time it was loaded, is not reloaded. As a result, there is little performance penalty for loading JAR files. Loading JAR files is a simple, fool-proof way to use the `loadjava` tool.

It is illegal for two schema objects in the same schema to define the same class. For example, assume that `a.java` defines class `x` and you want to move the definition of `x` to `b.java`. If `a.java` has already been loaded, then the `loadjava` tool will reject an attempt to load `b.java`. Instead, do either of the following:

- Drop `a.java`, load `b.java`, and then load the new `a.java`, which does not define `x`.
- Load the new `a.java`, which does not define `x`, and then load `b.java`.

Related Topics

- [Database Resident JARs](#)

13.3 Resolution of Schema Objects

All Java classes contain references to other classes. A conventional JVM searches for classes in the directories, ZIP files, and JAR files named in the `CLASSPATH`. In contrast, Oracle JVM searches schemas for class schema objects. Each class in the database has a resolver specification, which is Oracle Database counterpart to `CLASSPATH`. For example, the resolver specification of a class, `alpha`, lists the schemas to search for classes that `alpha` uses. Notice that resolver specifications are per-class, whereas in a classic JVM, `CLASSPATH` is global to all classes.

In addition to a resolver specification, each class schema object has a list of interclass reference bindings. Each reference list item contains a reference to another class and one of the following:

- The name of the class schema object to call when the class uses the reference

- A code indicating whether the reference is unsatisfied, that is, whether the referent schema object is known

Oracle Database facility known as **resolver** maintains reference lists. For each interclass reference in a class, the resolver searches the schemas specified by the resolver specification of the class for a valid class schema object that satisfies the reference. If all references are resolved, then the resolver marks the class valid. A class that has never been resolved, or has been resolved unsuccessfully, is marked invalid. A class that depends on a schema object that becomes invalid is also marked invalid at the time the first class is marked invalid. In other words, invalidation cascades upward from a class to the classes that use it and the classes that use these classes, and so on. When resolving a class that depends on an invalid class, the resolver first tries to resolve the referenced class, because it may be marked invalid only because it has never been resolved. The resolver does not resolve classes that are marked valid.

A developer can direct the `loadjava` tool to resolve classes or can defer resolution until run time. The resolver runs automatically when a class tries to load a class that is marked invalid. It is best to resolve before run time to learn of missing classes early. Unsuccessful resolution at run time produces a `ClassNotFoundException` exception. Furthermore, run-time resolution can fail for the following reasons:

- Lack of database resources, if the tree of classes is very large
- Deadlocks due to circular dependencies

The `loadjava` tool has two resolution modes:

- Load-and-resolve

The `-resolve` option loads all classes you specify on the command line, marks them invalid, and then resolves them. Use this mode when initially loading classes that refer to each other, and, in general, when reloading isolated classes as well. By loading all classes and then resolving them, this mode avoids the error message that occurs if a class refers to a class that will be loaded later while the command is being carried out.

- Load-then-resolve

This mode resolves each class at run time. The `-resolve` option is not specified.

 **Note:**

As with a Java compiler, the `loadjava` tool resolves references to classes but not to resources. Ensure that you correctly load the resource files that your classes need.

If you can, defer resolution until all classes have been loaded. This avoids a situation in which the resolver marks a class invalid because a class it uses has not yet been loaded.

13.4 Compilation of Schema Objects

Loading a source file creates or updates a Java source schema object and invalidates the class schema objects previously derived from the source. If the class schema objects do not exist, then the `loadjava` tool creates them. The `loadjava` tool

invalidates the old class schema objects because they were not compiled from the newly loaded source. Compilation of a newly loaded source, for example, class A, is automatically triggered by any of the following conditions:

- The resolver, while working on class B, finds that class B refers to class A, but class A is invalid.
- The compiler, while compiling the source of class B, finds that class B refers to class A, but class A is invalid.
- The class loader, while trying to load class A for running it, finds that class A is invalid.

To force compilation when you load a source file, use the `loadjava -resolve` option.

The compiler writes error messages to the predefined `USER_ERRORS` view. The `loadjava` tool retrieves and displays the messages produced by its compiler invocations.

The compiler recognizes some options. There are two ways to specify options to the compiler. If you run the `loadjava` tool with the `-resolve` option, then you can specify compiler options on the command line. You can additionally specify persistent compiler options in a per-schema database table, `JAVA$OPTIONS`. You can use the `JAVA$OPTIONS` table for default compiler options, which you can override selectively using a `loadjava` tool option.



Note:

A command-line option overrides and clears the matching entry in the `JAVA$OPTIONS` table.

A `JAVA$OPTIONS` row contains the names of source schema objects to which an option setting applies. You can use multiple rows to set the options differently for different source schema objects. The compiler looks up options in `JAVA$OPTIONS` when it has been called by the class loader or when called from the command line without specifying any options. When compiling a source schema object for which there is neither a `JAVA$OPTIONS` entry nor a command-line value for an option, the compiler assumes a default value, as follows:

- `encoding = System.getProperty("file.encoding");`
- `online = true`

This applies only to Java sources that contain SQLJ constructs.

- `debug = true`

This option is equivalent to `javac -g`.

13.5 The ojvmtc Tool

This section describes the following topics:

- [About the ojvmtc Tool](#)
- [Arguments of ojvmtc Command](#)

13.5.1 About the `ojvmtc` Tool

The `ojvmtc` tool enables you to resolve all external references, prior to running the `loadjava` tool. The `ojvmtc` tool allows the specification of a classpath that specifies the JARs, classes, or directories to be used to resolve class references. When an external reference cannot be resolved, this tool either produces a list of unresolved references or generated stub classes to allow resolution of the references, depending on the options specified. Generated stub classes throw a `java.lang.ClassNotFoundException` if it is referenced at runtime.

The syntax is:

```
ojvmtc [-help ] [-bootclasspath] [-server connect_string] [-jar jar_name] [-list] -
classpath jar1:path2:jar2
jars,...,classes
```

For example:

```
ojvmtc -bootclasspath $JAVA_HOME/jre/lib/rt.jar -classpath classdir/
lib1.jar:classdir/lib2.jar -jar set.jar app.jar
```

The preceding example uses `rt.jar`, `classdir/lib1.jar`, and `classdir/lib2.jar` to resolve references in `app.jar`. All the classes examined are added to `set.jar`, except for those found in `rt.jar`.

Another example is:

```
ojvmtc -server thin:HR/@localhost:5521:orcl -classpath jar1:jar2 -list app2.jar
Password:password
```

The preceding example uses classes found in the server specified by the connection string as well as `jar1` and `jar2` to resolve `app2.jar`. Any missing references are displayed to `stdout`.

13.5.2 Arguments of `ojvmtc` Command

[Table 13-1](#) summarizes the arguments of this command.

Table 13-1 `ojvmtc` Argument Summary

Argument	Description
<code>-classpath</code>	Uses the specified JARs and classes for the closure set.
<code>-bootclasspath</code>	Uses the specified classes for closure, but does not include them in the closure set.
<code>-server connect_string</code>	Connects to the server using visible classes in the same manner as <code>-bootclasspath</code> .

Table 13-1 (Cont.) ojvmtc Argument Summary

Argument	Description
connect_string thin OCI	Connects to the server using thin or Oracle Call Interface (OCI) specific driver. If you use thin driver, the syntax is as follows: thin:user/passwd@host:port:sid If you use OCI driver, the syntax is as follows: oci:user/passwd@host:port:sid oci:user/passwd@tnsname oci:user/passwd@(connect descriptor)
-jar jar_name	Writes each class of the closure set to a JAR and generates stubs for missing classes
-list	Lists the missing classes.

13.6 The loadjava Tool

The `loadjava` tool creates schema objects from files and loads them into a schema. Schema objects can be created from Java source, class, and data files. The `loadjava` tool can also create schema objects from SQLJ files.

You must have the following SQL database privileges to load classes:

- `CREATE PROCEDURE` and `CREATE TABLE` privileges to load into your schema.
- `CREATE ANY PROCEDURE` and `CREATE ANY TABLE` privileges to load into another schema.
- `oracle.aurora.security.JServerPermission.loadLibraryInClass.classname`.

You can run the `loadjava` tool either from the command line or by using the `loadjava` method contained in the `DBMS_JAVA` class. To run the tool from within your Java application, do the following:

```
call dbms_java.loadjava('... options...');
```

The options are the same as those that can be specified on the command line with the `loadjava` tool. Separate each option with a space. Do not separate the options with a comma. The only exception for this is the `-resolver` option, which contains spaces. For `-resolver`, specify all other options in the first input parameter and the `-resolver` options in the second parameter, as follows:

```
call dbms_java.loadjava('..options...', 'resolver_options');
```

Do not specify the `-thin`, `-oci`, `-user`, and `-password` options, because they relate to the database connection for the `loadjava` command-line tool. The output is directed to `stderr`. Set `serveroutput` on, and call `dbms_java.set_output`, as appropriate.

 **Note:**

The loadjava tool is located in the bin directory under \$ORACLE_HOME.

Just before the loadjava tool exits, it checks whether the processing was successful. All failures are summarized preceded by the following header:

```
The following operations failed
```

Some conditions, such as losing the connection to the database, cause the loadjava tool to terminate prematurely. These errors are displayed with the following syntax:

```
exiting: error_reason
```

This section covers the following:

- [loadjava Tool Syntax](#)
- [loadjava Tool Argument Summary](#)
- [loadjava Tool Argument Details](#)

13.6.1 loadjava Tool Syntax

The syntax of the loadjava tool command is as follows:

 **Note:**

- The (* -) option is the preferred option over the -genmissing and -genmissingjar options for resolving class references.
- The the -genmissing and -genmissingjar options cannot be used in an option file or an option table. These options are applicable to all the classes to be loaded and cannot be used only for specific classes.

```
loadjava {-user | -u} user [@database] [options]
file.java | file.class | file.jar | file.zip |
file.sqlj | resourcefile | URL...
[-casesensitivepub]
[-cleargrants]
[-debug]
[-d | -definer]
[-dirprefix prefix]
[-e | -encoding encoding_scheme]
[-fileout file]
[-f | -force]
[-genmissing]
[-genmissingjar jar_file]
[-g | -grant user [, user]...]
[-help]
[-jarasresource]
[-noaction]
[-nosynonym]
[-nousage]
```

```

[-noverify]
[-o | -oci | oci8]
[-optionfile file]
[-optiontable table_name]
[-publish package]
[-pubmain number]
[-recursivejars]
[-r | -resolve]
[-R | -resolver "resolver_spec"]
[-resolveonly]
[-S | -schema schema]
[-stdout]
[-stoponerror]
[-s | -synonym]
[-tableschem schema]
[-t | -thin]

[-unresolvedok]
[-v | -verbose]
[-jarsasdbobjects]
[-prependjarnames]
[-nativecompile]

```

13.6.2 loadjava Tool Argument Summary

[Table 13-2](#) summarizes the loadjava tool command arguments. If you run the loadjava tool multiple times specifying the same files and different options, then the options specified in the most recent invocation hold. However, there are two exceptions to this, as follows:

- If the loadjava tool does not load a file because it matches a digest table entry, then most options on the command line have no effect on the schema object. The exceptions are `-grant` and `-resolve`, which always take effect. You must use the `-force` option to direct the loadjava tool to skip the digest table lookup.
- The `-grant` option is cumulative. Every user specified in every invocation of the loadjava tool for a given class in a given schema has the EXECUTE privilege.

Table 13-2 loadjava Argument Summary

Argument	Description
<i>filenames</i>	You can specify any number and combination of .java, .class, .sqlj, .ser, .jar, .zip, and resource file name arguments.

Table 13-2 (Cont.) loadjava Argument Summary

Argument	Description
-proxy <i>host:port</i>	<p>If you do not have physical access to the server host or the loadjava client for loading classes, resources, and Java source, then you can use an HTTP URL with the loadjava tool to specify the JAR, class file, or resource and load the class from a remote server. <i>host</i> is the host name or address and <i>port</i> is the port the proxy server is using. The URL implementation must be such that the loadjava tool can determine the type of file to load, that is, JAR, class, resource, or Java source. For example:</p> <pre>loadjava -u HR -r -v -proxy proxy_server:1020 http:// my.server.com/this/is /the/path/my.jar Password: password</pre> <p>When the URL support is used inside the server, you should have proper Java permissions to access to the remote source. The URL support also includes ftp: and file: URLs.</p>
-casesensitivepub	<p>Publishing will create case-sensitive names. Unless the names are already all uppercase, it will usually require quoting the names in PL/SQL.</p>
-cleargrants	<p>The -grant option causes the loadjava tool to grant EXECUTE privileges to classes, sources, and resources. However, it does not cause it to revoke any privileges. If -cleargrants is specified, then the loadjava tool will revoke any existing grants of execute privilege before it grants execute privilege to the users and roles specified by the -grant operand. For example, if the intent is to have execute privilege granted to only HR, then the proper options are:</p> <pre>-grant HR -cleargrants</pre>
-debug	<p>Turns on SQL logging.</p>
-definer	<p>By default, class schema objects run with the privileges of their invoker. This option confers definer privileges upon classes instead. This option is conceptually similar to the UNIX setuid facility.</p>
-dirprefix <i>prefix</i>	<p>For any files or JAR entries that start with <i>prefix</i>, this <i>prefix</i> will be deleted from the name before the name of the schema object is determined. For classes and sources, the name of the schema object is determined by their contents. Therefore, this option will only have an effect for resources.</p>
-encoding	<p>Identifies the source file encoding for the compiler, overriding the matching value, if any, in the JAVA\$OPTIONS table. Values are the same as for the javac -encoding option. If you do not specify an encoding on the command line or in the JAVA\$OPTIONS table, then the encoding is assumed to be the value returned by:</p> <pre>System.getProperty("file.encoding");</pre> <p>This option is relevant only when loading a source file.</p>
-fileout <i>file</i>	<p>Displays all message to the designated file.</p>
-force	<p>Forces files to be loaded, even if they match digest table entries.</p>

Table 13-2 (Cont.) loadjava Argument Summary

Argument	Description
-genmissing	<p>Determines what classes and methods are referred to by the classes that the <code>loadjava</code> tool is asked to process. Any classes not found in the database or file arguments are called missing classes. This option generates dummy definitions for missing classes containing all the referred methods. It then loads the generated classes into the database. This processing happens before the class resolution.</p> <p>Because detecting references from source is more difficult than detecting references from class files, and because source is not generally used for distributing libraries, the <code>loadjava</code> tool will not attempt to do this processing for source files.</p> <p>The schema in which the missing classes are loaded will be the one specified by the <code>-user</code> option, even when referring classes are created in some other schema. The created classes will be flagged so that tools can recognize them. In particular, this is needed, so that the verifier can recognize the generated classes.</p>
-genmissingjar <i>jar_file</i>	<p>This option performs the same actions as <code>-genmissing</code>. In addition, it creates a JAR file, <i>jar_file</i>, that contains the definitions of any generated classes.</p>
-grant	<p>Grants the <code>EXECUTE</code> privilege on loaded classes to the listed users. Any number and combination of user names can be specified, separated by commas, but not spaces.</p> <p>Granting the <code>EXECUTE</code> privilege on an object in another schema requires that the original <code>CREATE PROCEDURE</code> privilege was granted with the <code>WITH GRANT</code> options.</p> <p>Note:</p> <ul style="list-style-type: none"> • <code>-grant</code> is a cumulative option. Users are added to the list of those with the <code>EXECUTE</code> privilege. To remove privileges, use the <code>-cleargrants</code> option. • The schema name should be used in uppercase.
-help	<p>Displays usage message on how to use the <code>loadjava</code> tool and its options.</p>
-jarasresource	<p>Instead of unpacking the JAR file and loading each class within it, loads the whole JAR file into the schema as a resource.¹</p>
-noaction	<p>Take no action on the files. Actions include creating the schema objects, granting execute permissions, and so on. The typical use is within an option file to suppress creation of specific classes in a JAR. When used on the command line, unless overridden in the option file, it will cause the <code>loadjava</code> tool to ignore all files. Except that JAR files will still be examined to determine if they contain a <code>META-INF/loadjava-options</code> entry. If so, then the option file is processed. The <code>-action</code> option in the option file will override the <code>-noaction</code> option specified on the command line.</p>
-norecursivejars	<p>Treat JAR files contained in other JAR files as resources. This is the default behavior. This option is used to override the <code>-recursivejars</code> option.</p>
-nosynonym	<p>Do not create a public synonym for the classes. This is the default behavior. This overrides the <code>-synonym</code> option.</p>

Table 13-2 (Cont.) loadjava Argument Summary

Argument	Description
-nousage	Suppresses the usage message that is given if either no option is specified or if the <code>-help</code> option is specified.
-noverify	Causes the classes to be loaded without bytecode verification. <code>oracle.aurora.security.JServerPermission(Verifier)</code> must be granted to use this option. To be effective, this option must be used in conjunction with <code>-resolve</code> .
-oci -oci8	Directs the <code>loadjava</code> tool to communicate with the database using the JDBC Oracle Call Interface (OCI) driver. <code>-oci</code> and <code>-thin</code> are mutually exclusive. If neither is specified, then <code>-oci</code> is used by default. Choosing <code>-oci</code> implies the syntax of the <code>-user</code> value. You do not need to provide the URL.
-optionfile <i>file</i>	A file can be provided with <code>loadjava</code> options.
-optiontable <i>tablename</i>	This option works like <code>-optionfile</code> , except that the source for the patterns and options is a SQL table rather than a file.
-publish <i>package</i>	The <i>package</i> is created or replaced by the <code>loadjava</code> tool. Wrappers for the eligible methods will be defined in this package. Through the use of option files, a single invocation of the <code>loadjava</code> tool can be instructed to create more than one package. Each package will undergo the same name transformations as the methods.
-pubmain <i>number</i>	A special case applied to methods with a single argument, which is of type <code>java.lang.String[]</code> . Multiple variants of the SQL procedure or function will be created, each of which takes a different number of arguments of type <code>VARCHAR</code> . In particular, variants are created taking all arguments up to and including <i>number</i> . The default value is 3. This option applies to <code>main</code> , as well as any method that has exactly one argument of type <code>java.lang.String[]</code> .
-recursivejars	Usually, if the <code>loadjava</code> tool encounters an entry in a JAR with a <code>.jar</code> extension, it will load the entry as a resource. If this option is specified, then the <code>loadjava</code> tool will process contained JAR files as if they were top-level JAR files. That is, it will read their entries and load classes, sources, and resources.
-resolve	Compiles, if necessary, and resolves external references in classes after all classes on the command line have been loaded. If you do not specify the <code>-resolve</code> option, the <code>loadjava</code> tool loads files, but does not compile or resolve them.
-resolver	Specifies an explicit resolver specification, which is bound to the newly loaded classes. If <code>-resolver</code> is not specified, then the default resolver specification, which includes current user's schema and <code>PUBLIC</code> , is used.
-resolveonly	Causes the <code>loadjava</code> tool to skip the initial creation step. It will still perform grants, resolves, create synonyms, and so on.

Table 13-2 (Cont.) loadjava Argument Summary

Argument	Description
-schema	<p>Designates the schema where schema objects are created. If not specified, then the <code>-user</code> schema is used. To create a schema object in a schema that is not your own, you must have the following privileges:</p> <ul style="list-style-type: none"> • CREATE TABLE or CREATE ANY TABLE • CREATE INDEX or CREATE ANY INDEX • SELECT ANY TABLE • UPDATE ANY TABLE • INSERT ANY TABLE • DELETE ANY TABLE • CREATE PROCEDURE or CREATE ANY PROCEDURE • ALTER ANY PROCEDURE <p>Finally, you must have the <code>JServerPermission loadLibraryInClass</code> for the class.</p> <p>Note: The above-mentioned privileges allow the grantee to create and manipulate tables in any schema except the SYS schema. For security reasons, Oracle recommends that you use these settings only with great caution.</p>
-stdout	Causes the output to be directed to <code>stdout</code> , rather than to <code>stderr</code> .
-stoponerror	Usually, if an error occurs while the <code>loadjava</code> tool is processing files, it will issue a message and continue to process other classes. This option stops when an error occurs. In addition, it reports all errors that apply to Java objects and are contained in the <code>USER_ERROR</code> table of the schema in which classes are being loaded. Except that it does not report <code>ORA-29524</code> errors. These are errors that are generated when a class cannot be resolved, because a referred class could not be resolved. Therefore, these errors are a secondary effect of whatever caused a referred class to be unresolved.
-synonym	Creates a <code>PUBLIC</code> synonym for loaded classes making them accessible outside the schema into which they are loaded. To specify this option, you must have the <code>CREATE PUBLIC SYNONYM</code> privilege. If <code>-synonym</code> is specified for source files, then the classes compiled from the source files are treated as if they had been loaded with <code>-synonym</code> .
-tableschema <i>schema</i>	Creates the <code>loadjava</code> tool internal tables within the specified schema, rather than in the Java file destination schema.
-thin	Directs the <code>loadjava</code> tool to communicate with the database using the JDBC Thin driver. Choosing <code>-thin</code> implies the syntax of the <code>-user</code> value. You do need to specify the appropriate URL through the <code>-user</code> option.
-unresolvedok	When combined with <code>-resolve</code> , will ignore unresolved errors.
-user	Specifies a user name, password, and database connection string. The files will be loaded into this database instance.
-verbose	Directs the <code>loadjava</code> tool to display detailed status messages while running. Use the <code>-verbose</code> option to learn when the <code>loadjava</code> tool does not load a file, because it matches a digest table entry.

Table 13-2 (Cont.) loadjava Argument Summary

Argument	Description
<code>-jarsasdbobjects</code>	Indicates that JARs processed by the current <code>loadjava</code> tool command are to be stored in the database as database resident JARs. ²
<code>-prependjarnames</code>	Is used with the <code>-jarsasdbobjects</code> option. This option enables classes with the same names coming from different JARs to coexist in the same schema. It does this by prefixing a version of the name of the JAR to the class name to produce a unique name for the database object.

¹ If you load a JAR file in this manner, then you *cannot* use it for resolution or execution.

² If you load a JAR file in this manner, then you *can* use it for resolution or execution.

13.6.3 loadjava Tool Argument Details

This section describes the details of some of the `loadjava` tool arguments whose behavior is more complex than the summary descriptions contained in the *loadjava Argument Summary* table.

File Names

You can specify as many `.class`, `.java`, `.sqlj`, `.jar`, `.zip`, and resource files as you want and in any order. If you specify a JAR or ZIP file, then the `loadjava` tool processes the files in the JAR or ZIP. There is no JAR or ZIP schema object. If a JAR or ZIP contains another JAR or ZIP, the `loadjava` tool does not process them.

The best way to load files is to put them in a JAR or ZIP and then load the archive. Loading archives avoids the resource schema object naming complications. If you have a JAR or ZIP that works with the Java Development Kit (JDK), then you can be sure that loading it with the `loadjava` tool will also work, without having to learn anything about resource schema object naming.

Schema object names are different from file names, and the `loadjava` tool names different types of schema objects differently. Because class files are self-identifying, the mapping of class file names to schema object names done by the `loadjava` tool is invisible to developers. Source file name mapping is also invisible to developers. The `loadjava` tool gives the schema object the fully qualified name of the first class defined in the file. JAR and ZIP files also contain the names of their files.

However, resource files are not self-identifying. The `loadjava` tool generates Java resource schema object names from the literal names you supply as arguments. Because classes use resource schema objects and the correct specification of resources is not always intuitive, it is important that you specify resource file names correctly on the command line.

The perfect way to load individual resource files correctly is to run the `loadjava` tool from the top of the package tree and specify resource file names relative to that directory.

 **Note:**

The top of the package tree is the directory you would name in a CLASSPATH.

If you do not want to follow this rule, then observe the details of resource file naming that follow. When you load a resource file, the `loadjava` tool generates the resource schema object name from the resource file name, as literally specified on the command line. For example, if you type:

```
% cd /home/HR/javastuff
% loadjava options alpha/beta/x.properties
% loadjava options /home/HR/javastuff/alpha/beta/x.properties
```

Although you have specified the same file with a relative and an absolute path name, the `loadjava` tool creates two schema objects, `alpha/beta/x.properties` and `ROOT/home/HR/javastuff/alpha/beta/x.properties`. The name of the resource schema object is generated from the file name as entered.

Classes can refer to resource files relatively or absolutely. To ensure that the `loadjava` tool and the class loader use the same name for a schema object, enter the name on the command line, which the class passes to `getResource()` or `getResourceAsString()`.

Instead of remembering whether classes use relative or absolute resource names and changing directories so that you can enter the correct name on the command line, you can load resource files in a JAR, as follows:

```
% cd /home/HR/javastuff
% jar -cf alpharesources.jar alpha/*.properties
% loadjava options alpharesources.jar
```

To simplify the process further, place both the class and resource files in a JAR, which makes the following invocations equivalent:

```
% loadjava options alpha.jar
% loadjava options /home/HR/javastuff/alpha.jar
```

The preceding `loadjava` tool commands imply that you can use any path name to load the contents of a JAR file. Even if you run the redundant commands, the `loadjava` tool would realize from the digest table that it need not load the files twice. This implies that reloading JAR files is not as time-consuming as it might seem, even when few files have changed between the different invocations of the `loadjava` tool.

definer

```
{-definer | -d}
```

This option is identical to the `definer` rights in stored procedures and is conceptually similar to the UNIX `setuid` facility. However, you can apply the `-definer` option to individual classes, in contrast to `setuid`, which applies to a complete program. Moreover, different definers may have different privileges. Because an application can consist of many classes, you must apply `-definer` with care to achieve the desired results. That is, classes run with the privileges they need, but no more.

noverify

`[-noverify]`

This option causes the classes to be loaded without bytecode verification. `oracle.aurora.security.JServerPermission(Verifier)` must be granted to run this option. Also, this option must be used in conjunction with `-resolve`.

The verifier ensures that incorrectly formed Java binaries cannot be loaded for running on the server. If you know that the JAR or classes you are loading are valid, then the use of this option will speed up the process associated with the `loadjava` tool. Some Oracle Database-specific optimizations for interpreted performance are put in place during the verification process. Therefore, the interpreted performance of your application may be adversely affected by using this option.

optionfile

`[-optionfile <file>]`

This option enables you to specify a file with different options that you can specify with the `loadjava` tool. This file is read and processed by the `loadjava` tool before any other `loadjava` tool options are processed. The file can contain one or more lines, each of which contains a pattern and a sequence of options. Each line must be terminated by a newline character (`\n`).

For each file or JAR entry that is processed by the `loadjava` tool, the long name of the schema object that is going to be created is checked against the patterns. Patterns can end in a wildcard (*) to indicate an arbitrary sequence of characters, or they must match the name exactly.

Options to be applied to matching Java schema objects are supplied on the rest of the line. Options are appended to the command-line options, they do not replace them. In case more than one line matches a name, the matching rows are sorted by length of pattern, with the shortest first, and the options from each row are appended. In general, the `loadjava` tool options are not cumulative. Rather, later options override earlier ones. This means that an option specified on a line with a longer pattern will override a line with a shorter pattern.

This file is parsed by a `java.io.StreamTokenizer`.

You can use Java comments in this file. A line comment begins with a #. Empty lines are ignored. The quote character is a double quote ("). That is, options containing spaces should be surrounded by double quotes. Certain options, such as `-user` and `-verbose`, affect the overall processing of the `loadjava` tool and not the actions performed for individual Java schema objects. Such options are ignored if they appear in an option file.

To help package applications, the `loadjava` tool looks for the `META-INF/loadjava-options` entry in each JAR it processes. If it finds such an entry, then it treats it as an options file that is applied for all other entries in the JAR file. However, the `loadjava` tool does some processing on entries in the order in which they occur in the JAR.

If the `loadjava` tool has partially processed entities before it processes `META-INF/loadjava-options`, then it attempts to patch up the schema object to conform to the applicable options. For example, the `loadjava` tool alters classes that were created with invoker rights when they should have been created with definer rights. The fix for `-noaction` is to drop the created schema object. This yields the correct effect, except

that if a schema object existed before the `loadjava` tool started, then it would have been dropped.

optiontable

```
[-optiontable table_name]
```

This option enables you to specify the properties of classes persistently. No mechanism is provided for loading the table. The table name must contain three character columns, `PATTERN`, `OPTION`, and `VALUE`. The value of `PATTERN` is interpreted in the same way as a pattern in an option file. The other two columns are the same as the corresponding command-line options and take an operand. Suppose, you create a table `FOO` with the following command:

```
create table foo (pattern varchar2(2000), option_name varchar2(2000), value
varchar2(2000));
```

Then, you can use the `optiontable` option in the following way:

```
loadjava -optiontable foo myjar.jar
```

For options that do not take an operand, the `VALUE` column should be `NULL`. The rows are processed in the same way as the lines of an option file are processed. To determine the options for a given schema object, the rows are examined and for any match the option is appended to the list of options. If two rows have the same pattern and contradictory options, such as `-synonym` and `-nosynonym`, then it is unspecified which will prevail. If two rows have the same pattern and option columns, then it is unspecified which `VALUE` will prevail.

publish

```
[-publish <package>]
[-pubmain <number>]
```

The publishing options cause the `loadjava` tool to create PL/SQL wrappers for methods contained in the processed classes. Typically, a user wants to publish wrappers for only a few classes in a JAR. These options are most useful when specified in an option file.

To be eligible for publication, the method must satisfy the following:

- It must be a member of a `public` class.
- It must be declared `public` and `static`.
- The method signature should satisfy the following rules so that it can be mapped:
 - Java arithmetic types for arguments and return values are mapped to `NUMBER`.
 - `char` as an argument and return type is mapped to `VARCHAR`.
 - `java.lang.String` as an argument and return type is mapped to `VARCHAR`.
 - If the only argument of the method has type `java.lang.String`, special rules apply, as listed in the `-pubmain` option description.
 - If the return type is `void`, then a procedure is created.
 - If the return type is an arithmetic, `char`, or `java.lang.String` type, then a function is created.

Methods that take arguments or return types that are not covered by the preceding rules are not eligible. No provision is made for OUT and IN OUT SQL arguments, OBJECT types, and many other SQL features.

resolve

```
{-resolve | -r}
```

Use `-resolve` to force the `loadjava` tool to compile and resolve a class that has previously been loaded. It is not necessary to specify `-force`, because resolution is performed after, and independent of, loading.

resolver

```
{-resolver | -R} resolver_specification
```

This option associates an explicit resolver specification with the class schema objects that the `loadjava` tool creates or replaces.

A resolver specification consists of one or more items, each of which consists of a name specification and a schema specification expressed in the following syntax:

```
"((name_spec schema_spec) [(name_spec schema_spec)] ...)"
```

A name specification is similar to a name in an `import` statement. It can be a fully qualified Java class name or a package name whose final element is the wildcard character asterisk (*) or simply an asterisk (*). However, the elements of a name specification must be separated by slashes (/), not periods (.). For example, the name specification `a/b/*` matches all classes whose names begin with `a.b`. The special name `*` matches all class names.

A schema specification can be a schema name or the wildcard character dash (-). The wildcard does not identify a schema, but directs the resolve operation not to mark a class invalid, because a reference to a matching name cannot be resolved. Use dash (-) when you must test a class that refers to a class you cannot or do not want to load. For example, GUI classes that a class refers to but does not call, because when run in the server there is no GUI.

When looking for a schema object whose name matches the name specification, the resolution operation looks in the schema named by the partner schema specification.

The resolution operation searches schemas in the order in which the resolver specification lists them. For example,

```
-resolver '((* HR) (* PUBLIC))'
```

This implies that search for any reference first in `HR` and then in `PUBLIC`. If a reference is not resolved, then mark the referring class invalid and display an error message.

Consider the following example:

```
-resolver '((* HR) (* PUBLIC) (my/gui/* -))'
```

This implies that search for any reference first in `HR` and then in `PUBLIC`. If the reference is to a class in the package `my.gui` and is not found, then mark the referring class valid and do not display an error. If the reference is not to a class in `my.gui` and is not found, then mark the referring class invalid and produce an error message.

user

```
{-user | -u} user/password[@database_url]
```

By default, the `loadjava` tool loads into the logged in schema specified by the `-user` option. You use the `-schema` option to specify a different schema to load into. This does not require you to log in to that schema, but does require that you have sufficient permissions to alter the schema.

The permissible forms of `@database_url` depend on whether you specify `-oci` or `-thin`, as described:

- `-oci:@database_url` is optional. If you do not specify, then the `loadjava` tool uses the user's default database. If specified, `database_url` can be a TNS name or an Oracle Net Services name-value list.
- `-thin:@database_url` is required. The format is `host:listener:SID`.

where:

- `host` is the name of the computer running the database.
- `listener` is the listener port that has been configured to listen for Oracle Net Services connections. In a default installation, it is 5521.
- `SID` is the database instance identifier. In a default installation, it is `ORCL`.

The following are examples of the `loadjava` tool commands:

- Connect to the default database with the default OCI driver, load the files in a JAR into the `TEST` schema, and then resolve them:

```
loadjava -u joe -resolve -schema TEST ServerObjects.jar  
Password: password
```

- Connect with the JDBC Thin driver, load a class and a resource file, and resolve each class:

```
loadjava -thin -u HR@dbhost:5521:orcl \  
-resolve alpha.class beta.props  
Password: password
```

- Add Betty and Bob to the users who can run `alpha.class`:

```
loadjava -thin -schema test -u HR@localhost:5521:orcl \  
-grant BETTY,BOB alpha.class  
Password: password
```

jarsasdbobjects

This option indicates that JARs processed by the current `loadjava` tool are to be stored in the database along with the classes they contain, and knowledge of the association between the classes and the JAR is to be retained in the database. In other words, this argument indicates that the JARs processed by the current `loadjava` tool are to be stored in the database as database resident JARs.

prependjarnames

This option is used with the `-jarsasdbobjects` option. This option enables classes with the same names coming from different JARs to coexist in the same schema.

Related Topics

- [Overview of Controlling the Current User](#)

13.7 The dropjava Tool

The `dropjava` tool is the converse of the `loadjava` tool. It transforms command-line file names and JAR or ZIP file contents to schema object names, drops the schema objects, and deletes their corresponding digest table rows. You can enter `.java`, `.class`, `.sqlj`, `.ser`, `.zip`, `.jar`, and resource file names on the command line and in any order.

Alternatively, you can specify a schema object name directly to the `dropjava` tool. A command-line argument that does not end in `.jar`, `.zip`, `.class`, `.java`, or `.sqlj` is presumed to be a schema object name. If you specify a schema object name that applies to multiple schema objects, then all will be removed.

Dropping a class invalidates classes that depend on it, recursively cascading upwards. Dropping a source drops classes derived from it.

Note:

You must remove Java schema objects in the same way that you first loaded them. If you load a `.sqlj` source file and translate it in the server, then you must run the `dropjava` tool on the same source file. If you translate on a client and load classes and resources directly, then run the `dropjava` tool on the same classes and resources.

You can run the `dropjava` tool either from the command line or by using the `dropjava` method in the `DBMS_JAVA` class. To run the `dropjava` tool from within your Java application, use the following command:

```
call dbms_java.dropjava('... options...');
```

The options are the same as specified on the command line. Separate each option with a space. Do not separate the options using commas. The only exception to this is the `-resolver` option. The connection is always made to the current session. Therefore, you cannot specify another user name through the `-user` option.

For `-resolver`, you should specify all other options first, a comma (`,`), then the `-resolver` option with its definition. Do not specify the `-thin`, `-oci`, `-user`, and `-password` options, because they relate to the database connection for the `loadjava` tool. The output is directed to `stderr`. Set `serveroutput` on and call `dbms_java.set_output`, as appropriate.

This section covers the following topics:

- [dropjava Tool Syntax](#)
- [dropjava Tool Argument Summary](#)
- [dropjava Tool Argument Details](#)
- [List Based Deletion](#)
- [About Dropping Resources Using dropjava Tool](#)

13.7.1 dropjava Tool Syntax

The syntax of the dropjava tool command is:

```
dropjava [options] {file.java | file.class | file.sqlj |
file.jar | file.zip | resourcefile} ...
-u | -user user/[password]@[database]
[-genmissingjar JARfile]
[-jarasresource]

[-o | -oci | -oci8]
[-optionfile file]
[-optiontable table_name]
[-S | -schema schema]
[-stdout]
[-s | -synonym]
[-t | -thin]

[-v | -verbose]
[-list]
[-listfile]
```

13.7.2 dropjava Tool Argument Summary

[Table 13-3](#) summarizes the dropjava tool arguments.

Table 13-3 dropjava Argument Summary

Argument	Description
-user	Specifies a user name, password, and optional database connection string. The files will be dropped from this database instance.
<i>filenames</i>	Specifies any number and combination of .java, .class, .sqlj, .ser, .jar, .zip, and resource file names.
-genmissingjar <i>JARfile</i>	Treats the operand of this option as a file to be processed.
-jarasresource	Drops the whole JAR file, which was previously loaded as a resource.
-oci -oci8	Directs the dropjava tool to connect with the database using the OCI JDBC driver. The -oci and the -thin options are mutually exclusive. If neither is specified, then the -oci option is used by default. Choosing the -oci option implies the form of the -user value.
-optionfile <i>file</i>	Has the same usage as for the loadjava tool.
-optiontable <i>table_name</i>	Has the same usage as for loadjava.
-schema <i>schema</i>	Designates the schema from which schema objects are dropped. If not specified, then the logon schema is used. To drop a schema object from a schema that is not your own, you need the DROP ANY PROCEDURE and UPDATE ANY TABLE privileges.
-stdout	Causes the output to be directed to stdout, rather than to stderr.

Table 13-3 (Cont.) dropjava Argument Summary

Argument	Description
-synonym	Drops a PUBLIC synonym that was created with the loadjava tool.
-thin	Directs the dropjava tool to communicate with the database using the JDBC Thin driver. Choosing the -thin option implies the form of the -user value.
-verbose	Directs the dropjava tool to emit detailed status messages while running.
-list	Drops the classes, Java source, or resources listed on the command line without them being present on the client machine or server machine.
-listfile	Reads a file and drops the classes, Java source, or resources listed in the file without them being present on the client machine or server machine. The file contains the internal representation of the complete class, Java source, or resource name one per line.

13.7.3 dropjava Tool Argument Details

This section describes a few of the dropjava tool arguments, which are complex.

File Names

The dropjava tool interprets most file names as the loadjava tool does:

- `.class` files
Finds the class name in the file and drops the corresponding schema object.
- `.java` and `.sqlj` files
Finds the first class name in the file and drops the corresponding schema object.
- `.jar` and `.zip` files
Processes the archived file names as if they had been entered on the command line.

If a file name has another extension or no extension, then the dropjava tool interprets the file name as a schema object name and drops all source, class, and resource objects that match the name.

If the dropjava tool encounters a file name that does not match a schema object, then it displays a message and processes the remaining file names.

user

```
{-user | -u} user/password[@database]
```

The permissible forms of `@database` depend on whether you specify `-oci` or `-thin`:

- `-oci:@database` is optional. If you do not specify, then the dropjava tool uses the user's default database. If specified, then `database` can be a TNS name or an Oracle Net Services name-value list.
- `-thin:@database` is required. The format is `host: lport: SID`.

where:

- *host* is the name of the computer running the database.
- *lport* is the listener port that has been configured to listen for Oracle Net Services connections. In a default installation, it is 5521.
- *SID* is the database instance identifier. In a default installation, it is ORCL.

The following are examples of the `dropjava` tool command:

- Drop all schema objects in the `TEST` schema in the default database that were loaded from `ServerObjects.jar`:

```
dropjava -u HR -schema TEST ServerObjects.jar
Password: password
```

- Connect with the JDBC Thin driver, then drop a class and a resource file from the user's schema:

```
dropjava -thin -u HR@dbhost:5521:orcl alpha.class beta.props
Password: password
```

List Based Deletion

Earlier versions of the `dropjava` tool required that the classes, JARs, source, and resources be present on the machine, where the client or server side utility is running. The current version of `dropjava` has an option that enables you to drop classes, resources, or sources based on a list of classes, which may not exist on the client machine or the server machine. This list can be either on the command line or in a text file. For example:

```
dropjava -list -u HR -v this.is.my.class this.is.your.class
Password: password
```

The preceding command drops the classes `this.is.my.class` and `this.is.your.class` listed on the command line without them being present on the client machine or server machine.

```
dropjava -listfile my.list -u HR -s -v
Password: password
```

The preceding command drops classes, resources, or sources and their synonyms based on a list of classes listed in `my.list` and displays verbosely.



Note:

The `'-install'` flag ignores the loading and dropping of system owned schema objects that cannot be modified.

These schema objects are the runtime classes, and resources provided by the `CREATE JAVA COMMAND`.

13.7.4 About Dropping Resources Using dropjava Tool

Care must be taken if you are removing a resource that was loaded directly into the server. This includes profiles, if you translated them on the client without using the `-`

`ser2class` option. When dropping source or class schema objects or resource schema objects that were generated by the server-side SQLJ translator, the schema objects will be found according to the package specification in the applicable `.sqlj` source file. However, the fully qualified schema object name of a resource that was generated on the client and loaded directly into the server depends on path information in the `.jar` file or that specified on the command line at the time you loaded it. If you use a `.jar` file to load resources and use the same `.jar` file to remove resources, then there will be no problem. However, if you use the command line to load resources, then you must be careful to specify the same path information when you run the `dropjava` tool to remove the resources.

13.8 The ojvmjava Tool

The `ojvmjava` tool is an interactive interface to the session namespace of a database instance. You specify database connection arguments when you start the `ojvmjava` tool. It then presents you with a prompt to indicate that it is ready for commands.

The shell can launch an executable, that is, a class with a `static main()` method. This is done either by using the command-line interface or by calling a database resident class. If you call a database resident class, the executable must be loaded with the `loadjava` tool.

This section covers the following topics:

- [ojvmjava Tool Syntax](#)
- [ojvmjava Tool Argument Summary](#)
- [ojvmjava Tool Example](#)
- [ojvmjava Tool Functionality](#)

13.8.1 ojvmjava Tool Syntax

The syntax of the `ojvmjava` tool command is:

```
ojvmjava {-user user[/password@database ] [options]
          [@filename]
          [-batch]
          [-c | -command command args]
          [-debug]
          [-d | -database conn_string]
          [-fileout filename]
          [-o | -oci | -oci8]
          [-oschema schema]
          [-t | -thin]
          [-version | -v]
          -runjava [server_file_system]
          -jdpw port [host]
          -verbose
```

13.8.2 ojvmjava Tool Argument Summary

[Table 13-4](#) summarizes the `ojvmjava` tool arguments.

Table 13-4 ojvmjava Argument Summary

Argument	Description
-user -u	Specifies user name for connecting to the database. This name is not case-sensitive. The name will always be converted to uppercase. If you provide the database information, then the default syntax used is OCI. You can also specify the default database.
-password -p	Specifies the password for connecting to the database.
@filename	Specifies a script file that contains the ojvmjava tool commands to be run.
-batch	Disables all messages displayed to the screen. No help messages or prompts will be displayed. Only responses to commands entered are displayed.
-command	Runs the desired command. If you do not want to run the ojvmjava tool in interpretive mode, but only want to run a single command, then run it with this option followed by a string that contains the command and the arguments. Once the command runs, the ojvmjava tool exits.
-debug	Displays debugging information.
-d -database conn_string	Provides a database connection string.
-fileout file	Redirects output to the provided file.
-o -oci -oci8	Uses the JDBC OCI driver. The OCI driver is the default. This flag specifies the syntax used in either the @database or -database option.
-o schema schema	Uses this schema for class lookup.
-t -thin	Specifies that the database syntax used is for the JDBC Thin driver. The database connection string must be of the form <i>host:port:SID</i> or an Oracle Net Services name-value list.
-verbose	Displays the connection information.
-version	Shows the version.
-runjava	Uses DBMS_JAVA.runjava when executing Java commands. With no argument, interprets -classpath as referring to the client file system. With argument <i>server_file_system</i> interprets -classpath as referring to the file system on which Oracle server is running, as DBMS_JAVA.runjava typically does.
-jdpw	Makes the connection listen for a debugger connection on the indicated port and host. The default value of host is localhost.

13.8.3 ojvmjava Tool Example

Open a shell on the session namespace of the database `orcl` on listener port 2481 on the host `dbserver`, as follows:

```
ojvmjava -thin -user HR@dbserver:2481:orcl
Password: password
```

13.8.4 ojvmjava Tool Functionality

The `ojvmjava` tool commands span several different types of functionality, which are grouped as follows:

- [ojvmjava Tool Command-Line Options](#)
- [ojvmjava Tool Shell Commands](#)

13.8.4.1 ojvmjava Tool Command-Line Options

This section describes the following options available with the `ojvmjava` tool command:

- [Scripting the ojvmjava Tool Commands in the @filename Option](#)
- `-runjava`
- `-jdwp`

Scripting the ojvmjava Tool Commands in the @filename Option

This `@filename` option designates a script file that contains one or more `ojvmjava` tool commands. The specified script file is located on the client. The `ojvmjava` tool reads the file and runs all commands on the designated server. In addition, because the script file is run on the server, any interaction with the operating system in the script file, such as redirecting output to a file or running another script, occurs on the server. If you direct the `ojvmjava` tool to run another script file, then this file must exist in `$ORACLE_HOME` on the server.

You must enter the `ojvmjava` tool command followed by any options and any expected input arguments. The script file contains the `ojvmjava` tool command followed by options and input parameters. The input parameters can be passed to the `ojvmjava` tool on the command line. The `ojvmjava` tool processes all known options and passes on any other options and arguments to the script file.

The following shows the contents of the script file, `execShell`:

```
java myclass a b c
```

To run this file, use the following command:

```
ojvmjava -user HR -thin -database dbserver:2481:orcl @commands  
Password: password
```

The `ojvmjava` tool processes all options that it knows about and passes along any other input parameters to be used by the commands that exist within the script file. In this example, the parameters are passed to the `java` command in the script file.

You can add any comments in your script file using the hash sign (`#`). Comments are ignored by the `ojvmjava` tool. For example:

```
#this whole line is ignored by ojvmjava
```

-runjava

This option controls whether or not the `ojvmjava` tool shell command Java runs executable classes using the command-line interface or database resident classes.

When the `-runjava` option is present the command-line interface is used. Otherwise, the executable must be a database resident class that was previously loaded with the `loadjava` tool. Using the optional argument `server_file_system` means that the `-classpath` terms are on the file system of the machine running Oracle server. Otherwise, they are interpreted as being on the file system of the machine running the `ojvmjava` tool.

-jdwp

This option specifies a debugger connection to listen for when the shell command `java` is used to run an executable. This allows for debugging the executable. The arguments specify the port and host. The default value of the host argument is `localhost`. These are used to execute a call to `DBMS_DEBUG_JDWP.CONNECT_TCP` from the RDBMS session, in which the executable is run.

Related Topics

- [About Using the Command-Line Interface](#)

13.8.4.2 ojvmjava Tool Shell Commands

This section describes the following commands available within the `ojvmjava` shell:

- [echo](#)
- [exit](#)
- [help](#)
- [java](#)
- [version](#)
- [whoami](#)
- [connect](#)
- [runjava](#)
- [jdwp](#)



Note:

An error is reported if you enter an unsupported command.

The following table summarizes the commands that share one or more common options:

Table 13-5 ojvmjava Command Common Options

Option	Description
<code>-describe</code> <code>-d</code>	Summarizes the operation of the tool.
<code>-help</code> <code>-h</code>	Summarizes the syntax of the tool.
<code>-version</code>	Shows the version.

echo

This command displays to `stdout` exactly what is indicated. This is used mostly in script files.

The syntax is as follows:

```
echo [echo_string] [args]
```

echo_string is a string that contains the text you want written to the screen during the shell script invocation and *args* are input arguments from the user. For example, the following command displays out a notification:

```
echo "Adding an owner to the schema" &1
```

If the input argument is `HR`, then the output would be:

```
Adding an owner to the schema HR
```

exit

This command terminates `ojvmjava`. The syntax is as follows:

```
exit
```

For example, to leave a shell, use the following command:

```
$ exit  
%
```

help

This command summarizes the syntax of the shell commands. You can also use the `help` command to summarize the options for a particular command. The syntax is as follows:

```
help [command]
```

java

This command is analogous to the JDK `java` command. It calls the static `main()` method of a class. It does this either by using the command-line interface or using a database resident class, depending on the setting of the `runjava` mode. In the latter case, the class must have been previously loaded with the `loadjava` tool. The command provides a convenient way to test Java code that runs in the database. In particular, the command catches exceptions and redirects the standard output and standard error of the class to the shell, which displays them as with any other command output. The destination of standard out and standard error for Java classes that run in the database is one or more database server process trace files, which are inconvenient and may require `DBA` privileges to read.

The syntax of the command with `runjava mode off` is:

```
java [-schema schema] class [arg1 ... argn]
```

The syntax of the command with `runjava mode on` is:

```
java [command-line options] class [arg1 ... argn]
```

where, command-line options can be any of those mentioned in [Table 3-1](#).

The following table summarizes the arguments of this command.

Table 13-6 java Argument Summary

Argument	Description
<i>class</i>	Names the Java class schema object that is to be run.
-schema	Names the schema containing the class to be run. The default is the invoker's schema. The schema name is case-sensitive.
<i>arg1 ... argn</i>	Arguments to the static <code>main()</code> method of the class.

Consider the following Java file, `World.java`:

```
package hello;
public class World
{
    public World()
    {
        super();
    }

    public static void main(String[] argv)
    {
        System.out.println("Hello from Oracle Database");
        if (argv.length != 0)
            System.out.println("You supplied " + argv.length + " arguments: ");
        for (int i = 0; i < argv.length; i++)
            System.out.println(" arg[" + i + "] : " + argv[i]);
    }
}
```

You can compile, load, publish, and run the class, as follows:

```
% javac hello/World.java

% loadjava -r -user HR@localhost:2481:orcl hello/World.class
Password: password
% ojvmjava -user HR -database localhost:2481:orcl
Password: password
$ java hello.World alpha beta
Hello from Oracle Database
You supplied 2 arguments:
arg[0] : alpha
arg[1] : beta
```

version

This command shows the version of the `ojvmjava` tool. You can also show the version of a specified command. The syntax of this command is:

```
version [options] [command]
```

For example, you can display the version of the shell, as follows:

```
$ version
1.0
```

whoami

This command displays the user name of the user who logged in to the current session. The syntax of the command is:

```
whoami
```

connect

This command enables the client to drop the current connection and connect to different databases without having to reinvoke the `ojvmjava` tool with a different connection description.

The syntax of this command is:

```
connect [-service service] [-user user][-password password]
```

You can use this command as shown in the following examples:

```
connect -s thin@localhost:5521:orcl -u HR/<password>
connect -s oci@localhost:5521:orcl -u HR -p <password>
```

The following table summarizes the arguments of this command.

Table 13-7 connect Argument Summary

Argument	Description
-service -s	Any valid JDBC driver URLs, namely, <code>oci @<connection descriptor></code> and <code>thin@<host:port:db></code>
-user -u	User to connect as
-password -p	Password to connect with

runjava

This command queries or modifies the `runjava` mode. The `runjava` mode determines whether or not the `java` command uses the command-line interface to run executables. The `java` command:

- Uses the command-like interface when `runjava` mode is `on`
- Uses database resident executables when `runjava` mode is `off`

Using the `runjava` command with no arguments displays the current setting of `runjava` mode.

The following table summarizes the arguments of this command.

Table 13-8 runjava Argument Summary

Argument	Description
<code>off</code>	Turns <code>runjava</code> mode <code>off</code> .
<code>on</code>	Turns <code>runjava</code> mode <code>on</code> .

Table 13-8 (Cont.) runjava Argument Summary

Argument	Description
server_file_system	Turns runjava mode on. Using this option means that -classpath terms are on the file system of the machine running Oracle server. Otherwise, they are interpreted as being on the file system of the machine running the ojvmjava tool.

jdwp

This command queries or modifies whether and how a debugger connection is listened for when an executable is run by the Java command.

**Note:**

The RDBMS session, prior to starting the executable, executes a `DBMS_DEBUG_JDWP.CONNECT_TCP` call with the specified port and host. This is called **Listening**.

Using this command with no arguments displays the current setting.

The following table summarizes the arguments of this command.

Table 13-9 jdwp Argument Summary

Argument	Description
off	Stops listening in future executables.
port	Enables listening and specifies the port to be used.
host	Enables listening and specifies the host to be used. The default value for this argument is <code>localhost</code> .

14

Database Web Services

This chapter provides an overview of database Web services and discusses how to call existing Web services. This chapter contains the following sections:

- [Overview of Database Web Services](#)
- [About Using Oracle Database as Web Services Consumer](#)

14.1 Overview of Database Web Services

Web services enable application-to-application interaction over the Web, regardless of platform, language, or data formats. The key ingredients, including Extensible Markup Language (XML), Simple Object Access Protocol (SOAP), Web Services Description Language (WSDL), REpresentational State Transfer (REST), Web Application Description Language (WADL), and Universal Description, Discovery, and Integration (UDDI), have been adopted across the entire software industry. Web services usually refer to services implemented and deployed in middle-tier application servers. However, in heterogeneous and disconnected environments, there is an increasing need to access stored procedures, as well as data and metadata, through Web services interfaces.

Oracle Database can access Web services through PL/SQL packages and Java classes deployed within the database. Consuming external Web services from the database, together with integration with the SQL engine, enables Enterprise Information Integration.

14.2 About Using Oracle Database as Web Services Consumer

You can extend the storage, indexing, and searching capabilities of a relational database to include semistructured and nonstructured data, including Web services, in addition to enabling federated data. By calling Web services, the database can track, aggregate, refresh, and query dynamic data produced on-demand, such as stock prices, currency exchange rates, and weather information.

An example of using Oracle Database as a service consumer would be to call external Web services from a predefined database job to retrieve inventory information from multiple suppliers, and then update your local inventory database. Another example is that of a Web crawler, where a database job can be scheduled to collate product and price information from a number of sources.

This section covers the following topics:

- [How to use the Oracle JVM Web Services Call-Out Utility](#)
- [Web Service Data Sources \(Virtual Table Support\)](#)
- [Features of Oracle Database as a Web Service Consumer](#)

14.2.1 About Using Oracle JVM Web Services Call-Out Utility

Starting from Oracle Database 12c Release 2 (12.2.0.1), you can use the Oracle JVM Web Services Call-Out Utility to call the operations from the Web services running in the network, from Oracle Database. This utility accepts the SOAP Web services specified in WSDL format or REST Web services specified in WADL format.

Perform the following before using this utility:

- Set the `JAVA_HOME` environment variable.
- Use the following command to create the `OJVMWCU_INSTALL` schema:

```
create user OJVMWCU_INSTALL identified by <ANY_PASSWORD>
```

Note:

- You must create the `OJVMWCU_INSTALL` schema before running the `install_ojvmwcu.sql` script. The `install_ojvmwcu.sql` script checks whether the `OJVMWCU_INSTALL` schema is present in the database or not. If not, then it displays a message that the schema is not present and stops running.
 - The `OJVMWCU_INSTALL` schema is created only for using the Oracle JVM Web Services Call-Out Utility and should not be used for any other purpose.
- Run the `install_ojvmwcu.sql` script, followed by the `grant_ojvmwcu.sql` script. Both the script files are present in the `ORACLE_HOME/javavm/ojvmwcu/install` directory.

The `grant_ojvmwcu.sql` script takes user name as argument, and it must be invoked as `SYSDBA`. For example: `sqlplus / as sysdba @ grant_ojvmwcu.sql scott`

The following sections describe this utility in details:

- [Architecture of Oracle JVM Web Services Call-Out Utility](#)
- [Input to Oracle JVM Web Services Call-Out Utility](#)
- [Output of the Oracle JVM Web Services Call-Out Utility](#)
- [Calling Secure Web Service from Oracle JVM Web Services Call-Out Utility](#)

14.2.1.1 Architecture of Oracle JVM Web Services Call-Out Utility

The Oracle JVM Web services Call-Out utility consists of the following two phases:

- Client Stub Generation
- Oracle JVM-specific Artifact Generation

The following figure illustrates the architecture of the Oracle JVM Web Services Call-Out Utility.

Figure 14-1 Oracle JVM Web Services Call-Out Utility Architecture

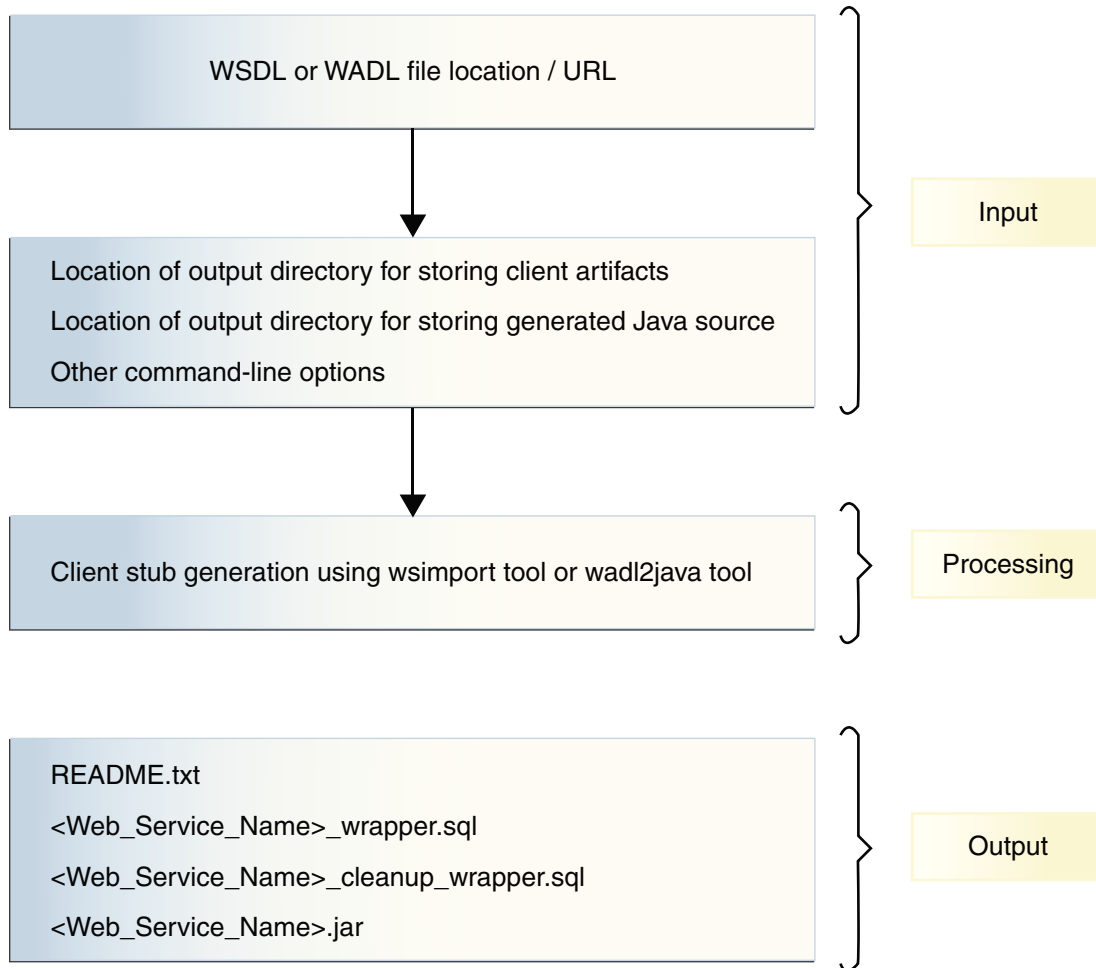

Client Stub Generation

The Oracle JVM Web Services Call-Out Utility uses the JAX-WS library and generates Java client stubs from the input specified in the “Input of Oracle JVM Web Services Call-Out Utility” section for accessing SOAP Web services. For REST services, the Oracle JVM Web Services Call-Out Utility uses the Third Party Tool `wadl2java`, which you must download separately.

 **Note:**

If you use REST services, then after downloading the `wadl2java` tool, you must perform either of the following:

- Set the `WADL_HOME` environment variable to the path of the `wadl2java` tool directory
- Use the `-t` command-line option to specify the path of the `wadl2java` tool directory

Oracle JVM-Specific Artifact Generation

For accessing the web services from PL/SQL, you need a static Java method and a PL/SQL wrapper function for each of the operations supported by the Web service. The Oracle JVM Web Services Call-Out Utility creates a static method for each of the supported operations in the Web service and extracts the details of the operations from the generated client classes by interpreting the different annotations. The extracted information includes `WebService`, `Webmethods`, `WebServiceClient`, and `WebEndpoint`. Using this information, the utility generates corresponding static methods in such a way that each of the operation has the same input parameters and return types as the corresponding operation in the published Web service. Then it adds all the static methods, corresponding to each of the supported operations, to a Java class.

The Oracle JVM Web services Call-Out utility then creates PL/SQL wrapper functions corresponding to each of the static methods in the generated Java class and packs the functions into a PL/SQL package with the name of the Web service. It also generates the PL/SQL wrapper for granting and revoking the basic permissions for running the Java Class in Oracle JVM.

14.2.1.2 Input to Oracle JVM Web Services Call-Out Utility

The input to the Oracle JVM Web Services Call-Out Utility mainly includes the WSDL or WADL file location, output directory to store the client artifacts, output directory to store the generated Java sources, if required, and the verbose mode. This utility reports any missing mandatory arguments and adds default values for the optional arguments. The following table describes the command-line arguments of the Oracle JVM Web Services Call-Out Utility.

Table 14-1 Input to Oracle JVM Web Services Call-Out Utility

Argument	Argument Type	Description
<code>-i <command-line options file></code>	Web Service	Specifies the file where other command-line options are stored.
<code>-out <output directory></code>	Web Service	Specifies the directory where the output files are stored. The default value is the current directory.

Table 14-1 (Cont.) Input to Oracle JVM Web Services Call-Out Utility

Argument	Argument Type	Description
-p	Web Service	Specifies the package name for the generated Client Stubs. The default value is <code>ojvm.webservice</code> .
-keepsrc	Web Service	Indicates to store the generated sources to the output directory.
-v	Web Service	Enables verbose mode for detailed description.
-Xauthfile	Web Service	Indicates the name of the file that contains authorization information in the format <code>http://username:password@_web-service URL_?wsdl</code> .
-name	Web Service	Specifies the name for the Web Service. The operations of the Web Service are put under a PL/SQL package specified with this value. The default value is <code>defaultWebService</code> .
-log	Web Service	Specifies the log file to store the output stream of Oracle JVM Web Services Call-Out Utility. If you do not provide this value, then the output stream is displayed on <code>System.out</code> .
-wsdl <WSDL location>	Web Service	Specifies the hosted location of the WSDL file. This option is mutually exclusive with the <code>-WADL</code> option.
-wadl <WADL location>	Web Service	Specifies the hosted location of the WADL file. This option is mutually exclusive with the <code>-WSDL</code> option.
-t <wadl2java tool location>	Web Service	Specifies the location of the <code>wadl2java</code> tool directory. By default, the <code>WADL_HOME</code> environment variable that points to <code>wadl2java</code> tool Home directory is checked. If this environment variable is not set properly, then an error is thrown.

Table 14-1 (Cont.) Input to Oracle JVM Web Services Call-Out Utility

Argument	Argument Type	Description
-cp <additional classpath>	Web Service	Specifies the class path that is used to compile the Java source files. You can either use the value of the CLASSPATH variable or specify the value using this option.
-auto	Web Service	Automatically loads the generated classes to the specified database. For this option to work, the following fields are mandatory: <ul style="list-style-type: none"> • -user • -orasid/-oraserv
-ts <trust_store path>	Web Service	Specifies the path to the trustore in which the SSL certificate is imported.
-user	Auto Mode	Specifies the user who is supposed to invoke the Web Service.
-dbhost <host_name>	Database	Specifies the host name where Oracle Database is installed. This field is used when auto mode is specified. The default value is localhost.
-dbport <port_number>	Database	Specifies the port number in which Oracle Database runs. This field is used when auto mode is specified. The default value is 1521.
-orasid <Oracle SID>	Database	Specifies the SID of the Oracle Database registered to the listener. This field is used when auto mode is specified.
-oraserv <name of corresponding CDB>	Database	Specifies the name of the CDB (container database) to which the classes should be loaded. This field is used when auto mode is specified.

14.2.1.3 Output of the Oracle JVM Web Services Call-Out Utility

The following table describes the output of the Oracle JVM Web Services Call-Out Utility.

Table 14-2 Output of the Oracle JVM Web Services Call-Out Utility

File Name	Description
README.txt	This file contains instructions to manually load the classes, grant the permissions, and run them.
<Web_Service_Name>_wrapper.sql	This SQL file is used to create PL/SQL wrappers for each operations in the specified Web service.
<Web_Service_Name>.jar	This JAR file contains the client stub classes for the Web services.

 **Note:**

With REST Web services, all Web method wrappers return Web response in String format. Though `GenericType` is supported with Jersey-Client, Oracle JVM Web Services Call-Out Utility does not support it.

14.2.1.4 Calling Secure Web Service from Oracle JVM Web Services Call-Out Utility

The Oracle JVM Web Services Call-Out Utility provides support for SSL based Web services. This utility also provides support for Web services secured with basic HTTP authentication. If you are using an SSL based Web service, then you must add SSL certificate to Keystore before running this utility or use the `-ts` command-line option to pass truststore path. Before the Web call out, you must use the `grabAndSaveCertificate<WebServiceName>(host, port)` procedure from `wrappers.sql` file for setting the path to key store path. If you are using Web services secured with basic authentication, then use the `-Xauthfile<auth_file>` command-line option with this utility. The `auth_file` argument contains authorization information in the following format:

```
http://username:password@<web-serviceURL>?wsdl
```

Before the Web call out, you must use `setwsCred<WebServiceName>(usr, pwd)` from `wrappers.sql` file for setting the Web service credentials.

14.2.2 Web Service Data Sources (Virtual Table Support)

To access data that is returned from single or multiple Web service invocations, create a virtual table using a Web service data source. This table lets you query a set of returned rows as though it were a table.

The client calls a Web service and the results are stored in a virtual table in the database. You can pass result sets from function to function. This enables you to set up a sequence of transformation without a table holding intermediate results. To reduce memory usage, you can return the result set rows, a few at a time, within a function.

By using Web services with the table function, you can manipulate a range of input values from single or multiple Web services as a real table. In the following example, the inner `SELECT` statement creates rows whose columns are used as arguments for calling the `CALL_WS` Web service call-out.

```
SELECT column1, cloumn2, ...
FROM TABLE(WS_TABFUN(CURSOR(SELECT s FROM table_name)))
WHERE ...
```

The table expression in the preceding example can be used in other SQL queries, for constructing views, and so on.

Figure 14-2 illustrates the support for virtual table.

Figure 14-2 Storing Results from Request in a Virtual Table

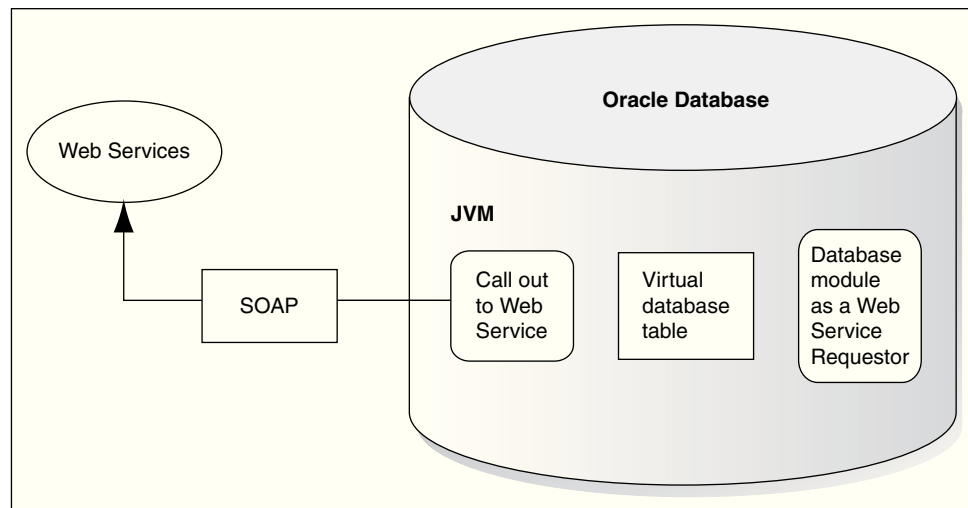

14.2.3 Features of Oracle Database as a Web Service Consumer

Using Oracle Database as a Web service consumer provides the following features:

- Consuming Web services from Java
Provides an easy-to-use interface for Web services call-outs, thereby insulating developers from low-level SOAP programming. Java classes running in the database can directly call external Web services by using the previously loaded Java proxy class or through dynamic invocation.
- Consuming Web services from SQL and PL/SQL
Enables any SQL-enabled tool or application to transparently and easily consume dynamic data from external Web services. After exposing Web services methods as Java stored procedures, a PL/SQL wrapper on top of a Java stored procedure hides all Java and SOAP programming details from the SQL client.
- Using Web services data source
Enables application and data integration by turning external Web service into a SQL data source, making the external Web service appear as regular SQL table.

This table function represents the output of calling external Web services and can be used in a SQL query.

A

DBMS_JAVA Package

This chapter provides a description of the `DBMS_JAVA` package. The functions and procedures in this package provide an entry point for accessing RDBMS functionality from Java.

A.1 longname

```
FUNCTION longname (shortname VARCHAR2) RETURN VARCHAR2
```

Returns the fully qualified name of the specified Java schema object. Because Java classes and methods can have names exceeding the maximum SQL identifier length, Oracle JVM uses abbreviated names internally for SQL access. This function returns the original Java name for any truncated name. An example of this function is to display the fully qualified name of classes that are invalid:

```
SELECT dbms_java.longname (object_name) FROM user_objects  
WHERE object_type = 'JAVA CLASS' AND status = 'INVALID';
```



See Also:

["Shortened Class Names"](#)

A.2 shortname

```
FUNCTION shortname (longname VARCHAR2) RETURN VARCHAR2
```

You can specify a full name to the database by using the `shortname()` routine of the `DBMS_JAVA` package, which takes a full name as input and returns the corresponding short name. This is useful when verifying that your classes loaded by querying the `USER_OBJECTS` view.



See Also:

["Shortened Class Names"](#)

A.3 get_compiler_option

```
FUNCTION get_compiler_option(name VARCHAR2, optionName VARCHAR2) RETURN VARCHAR2
```

Returns the value of the option specified through the `optionName` parameter. It is one of the functions used to control the options of the Java compiler supplied with Oracle Database.

A.4 set_compiler_option

```
PROCEDURE set_compiler_option(name VARCHAR2, optionName VARCHAR2, value VARCHAR2)
```

Is used to set the options of the Java compiler supplied with Oracle Database.

A.5 reset_compiler_option

```
PROCEDURE reset_compiler_option(name VARCHAR2, optionName VARCHAR2)
```

Is used to reset the specified compiler option to the default value.

A.6 resolver

```
FUNCTION resolver (name VARCHAR2, owner VARCHAR2, type VARCHAR2) RETURN VARCHAR2
```

Returns the resolver specification for the object specified in `name` and in the schema specified in `owner`, where the object is of the type specified in `type`. The caller must have `EXECUTE` privilege and have access to the given object to use this function.

The `name` parameter is the short name of the object.

The value of `type` can be either `SOURCE` or `CLASS`.

If there is an error, then `NULL` is returned. If the underlying object has changed, then `ObjectTypeChangedException` is thrown.

You can call this function as follows:

```
SELECT dbms_java.resolver('tst', 'HR', 'CLASS') FROM DUAL;
```

This would return:

```
DBMS_JAVA.RESOLVER('TST','HR','CLASS')
-----
(( * HR)( * PUBLIC))
```

A.7 derivedFrom

```
FUNCTION derivedFrom (name VARCHAR2, owner VARCHAR2, type VARCHAR2) RETURN VARCHAR2
```

Returns the source name of the object specified in `name` of the type specified in `type` and in the schema specified in `owner`. The caller must have `EXECUTE` privilege and have access to the given object to use this function.

The `name` parameter, as well as the returned source name, is the short name of the object.

The value of `type` can be either `SOURCE` or `CLASS`.

If there is an error, then `NULL` is returned. If the underlying object has changed, then `ObjectTypeChangedException` is thrown.

The returned value will be `NULL` if the object was not compiled in Oracle JVM.

You can call this function as follows:

```
SELECT dbms_java.derivedFrom('tst', 'HR', 'CLASS') FROM DUAL;
```

This would return:

```
DBMS_JAVA.DERIVEDFROM('TST','HR','CLASS')
-----
tst
```

A.8 fixed_in_instance

```
FUNCTION fixed_in_instance (name VARCHAR2, owner VARCHAR2, type VARCHAR2) RETURN
NUMBER
```

Returns the permanently kept status for object specified in `name` of the type specified in `type` and in the schema specified in `owner`. The caller must have `EXECUTE` privilege and have access to the given object to use this function.

The `name` parameter is the short name for the object.

The value of `type` can be either of `RESOURCE`, `SOURCE`, `CLASS`, or `SHARED_DATA`.

The number returned is either 0, indicating the status is not kept, or 1, indicating the status is kept.

You can call this function as follows:

```
SELECT dbms_java.fixed_in_instance('tst', 'HR', 'CLASS') FROM DUAL;
```

This would return:

```
DBMS_JAVA.FIXED_IN_INSTANCE('TST','HR','CLASS')
-----
0
```

Consider the following statement:

```
SELECT dbms_java.fixed_in_instance('java/lang/String', 'SYS', 'CLASS') FROM DUAL;
```

This would return:

```
DBMS_JAVA.FIXED_IN_INSTANCE('JAVA/LANG/STRING','SYS','CLASS')
-----
1
```

A.9 set_output

```
PROCEDURE set_output (bufferize NUMBER)
```

Redirects the output of Java stored procedures and triggers to the `DBMS_OUTPUT` package.



See Also:

["Redirecting the Output"](#)

A.10 export_source

```
PROCEDURE export_source(name VARCHAR2, schema VARCHAR2, src BLOB)
```

```
PROCEDURE export_source(name VARCHAR2, src BLOB)
```

```
PROCEDURE export_source(name VARCHAR2, src CLOB)
```

```
PROCEDURE export_source(name varchar2, schema varchar2, src CLOB)
```

Are used to export the Java source as a Java source schema object to Oracle Database. The source is specified through the `name` parameter. The source can be exported into a `BLOB` or `CLOB` object. The internal representation of the source uses the UTF8 format, so that format is used to store the source in the `BLOB` as well. The source schema object is created in the specified schema. If the schema is not specified then the current schema is used.

A.11 export_class

```
PROCEDURE export_class(name VARCHAR2, schema VARCHAR2, src BLOB)
```

```
PROCEDURE export_class(name VARCHAR2, src BLOB)
```

Are used to export Java classes specified through the `name` parameter as Java class schema objects to Oracle Database. You cannot export a class into a `CLOB` object, only into a `BLOB` object. If the schema is specified, then the class schema object is created in this schema, else in the current schema.

A.12 export_resource

```
PROCEDURE export_resource(name VARCHAR2, schema VARCHAR2, src BLOB)
```

```
PROCEDURE export_resource(name VARCHAR2, src BLOB)
```

```
PROCEDURE export_resource(name VARCHAR2, schema VARCHAR2, src CLOB)
```

```
PROCEDURE export_resource(name VARCHAR2, src CLOB)
```

The resource specified through the `name` parameter is exported to Oracle Database as a resource schema object in the schema specified through the `schema` parameter. If the schema is not specified then the current schema is used. The resource can be exported into either a `CLOB` object or `BLOB` object.

A.13 loadjava

```
PROCEDURE loadjava(options VARCHAR2)
```

```
PROCEDURE loadjava(options VARCHAR2, resolver VARCHAR2)
```

```
PROCEDURE loadjava(options VARCHAR2, resolver VARCHAR2, status NUMBER)
```

Enable you to load classes in to the database using a call, rather than through the `loadjava` command-line tool. You can call this procedure within your Java application as follows:

```
CALL dbms_java.loadjava('... options...');
```

The options are identical to those specified on the command line. Each option should be separated by a space. Do not separate the options with a comma. The only exception to this is the `loadjava -resolver` option, which contains spaces. For `-resolver`, specify all other options first, separate these options by a comma, and then specify the `-resolver` options, as follows:

```
CALL dbms_java.loadjava('... options...', 'resolver_options');
```

Do not specify the `-thin`, `-oci`, `-user`, and `-password` options, because they relate to the database connection. The output is directed to `System.err`. The output typically goes to a trace file, but can be redirected.

 **See Also:**

["The loadjava Tool"](#)

A.14 dropjava

```
PROCEDURE dropjava(options VARCHAR2)
```

Enables you to drop classes within the database using a call, rather than through the `dropjava` command-line tool. You can call this procedure within your Java application as follows:

```
CALL dbms_java.dropjava('... options...');
```

 **See Also:**

["The dropjava Tool"](#)

A.15 grant_permission

```
PROCEDURE grant_permission(grantee VARCHAR2, permission_type VARCHAR2,  
permission_name VARCHAR2,  
permission_action VARCHAR2)
```

The result of a call to `grant_permission` is an active row in the policy table granting the permission as specified by `permission_type`, `permission_name`, and `permission_action` to `grantee`. If an enabled row matching these parameters already exists, then the table is unmodified. If the row exists but is disabled, then it is enabled. If no matching row exists, then one row is inserted. Parameter descriptions:

- `grantee` is the name of a schema or role
- `permission_type` is the fully qualified name of a class that extends `java.lang.security.Permission`
- `permission_name` is the name of the `Permission`
- `permission_action` is the action of the `Permission`

**See Also:**

["Fine-Grain Definition for Each Permission"](#)

A.16 grant_permission

```
PROCEDURE grant_permission(grantee VARCHAR2, permission_type VARCHAR2,  
permission_name VARCHAR2,  
permission_action VARCHAR2, key OUT NUMBER)
```

Adds a new policy table row granting the permission as determined by the parameters.

Parameter descriptions:

- grantee is the name of a schema or role
- permission_type is the fully qualified name of a class that extends `java.lang.security.Permission`
- permission_name is the name of the Permission
- permission_action is the action of the Permission
- key is the key of the newly inserted row that grants the Permission. This value is -1, if an error occurs.

**See Also:**

["Fine-Grain Definition for Each Permission"](#)

A.17 restrict_permission

```
PROCEDURE restrict_permission(grantee VARCHAR2, permission_type VARCHAR2,  
permission_name VARCHAR2,  
permission_action VARCHAR2)
```

Results in an active row in the policy table restricting the permission as specified by `permission_type`, `permission_name`, and `permission_action` to grantee. If a restricting row matching these parameters already exists then the table is unmodified. If no matching row exists then one is inserted.

Parameter descriptions:

- grantee is the name of a schema or role
- permission_type is the fully qualified name of a class that extends `java.lang.security.Permission`
- permission_name is the name of the Permission
- permission_action is the action of the Permission

 **See Also:**

["Fine-Grain Definition for Each Permission"](#)

A.18 restrict_permission

```
PROCEDURE restrict_permission(grantee VARCHAR2, permission_type VARCHAR2,  
permission_name VARCHAR2,  
permission_action VARCHAR2, key OUT NUMBER)
```

Adds a new policy table row restricting the permission as determined by the parameters.

Parameter descriptions:

- `grantee` is the name of a schema or role
- `permission_type` is the fully qualified name of a class that extends `java.lang.security.Permission`
- `permission_name` is the name of the Permission
- `permission_action` is the action of the Permission
- `key` is the key of the newly inserted row that grants the Permission. This value is `-1`, if an error occurs.

 **See Also:**

["Fine-Grain Definition for Each Permission"](#)

A.19 grant_policy_permission

```
PROCEDURE grant_policy_permission(grantee VARCHAR2, permission_schema VARCHAR2,  
permission_type VARCHAR2,  
permission_name VARCHAR2)
```

A specialized version of the `grant_permission(grantee VARCHAR2, permission_type VARCHAR2, permission_name VARCHAR2, permission_action VARCHAR2)` procedure for granting `PolicyTablePermission` permissions.

Parameter descriptions:

- `grantee` is the name of a schema or role
- `permission_schema` is the schema of the permission
- `permission_type` is the fully qualified name of a class that extends `java.lang.security.Permission`
- `permission_name` is the name of the Permission, which can be a glob asterisk (`'*`)

**See Also:**

["Acquiring Administrative Permission to Update Policy Table"](#)

A.20 grant_policy_permission

```
PROCEDURE grant_policy_permission(grantee VARCHAR2, permission_schema VARCHAR2,  
permission_type VARCHAR2,  
permission_name VARCHAR2, key OUT NUMBER)
```

A specialized version of the `grant_permission(grantee VARCHAR2, permission_type VARCHAR2, permission_name VARCHAR2, permission_action VARCHAR2, key OUT NUMBER)` procedure for granting `PolicyTablePermission` permissions. Parameter descriptions:

- `grantee` is the name of a schema or role
- `permission_schema` is the schema of the permission
- `permission_type` is the fully qualified name of a class that extends `java.lang.security.Permission`
- `permission_name` is the name of the `Permission`, which can be a glob asterisk (*)
- `key` is the key of the newly inserted row that grants the `Permission`. This value is `-1`, if an error occurs.

**See Also:**

["Acquiring Administrative Permission to Update Policy Table"](#)

A.21 revoke_permission

```
PROCEDURE revoke_permission(permission_schema VARCHAR2, permission_type VARCHAR2,  
permission_name VARCHAR2,  
permission_action VARCHAR2)
```

Disables every active permission in the policy table that matches the parameters. The result is the same as calling the `"disable_permission"` procedure on every matching row. The rows are not deleted and kept in the table and can be activated by a call to `"grant_permission"` procedure with parameters matching those in the `revoke_permission` procedure.

Parameter descriptions:

- `permission_schema` is the name of a schema or role
- `permission_type` is the fully qualified name of a class that extends `java.lang.security.Permission`
- `permission_name` is the name of the `Permission`
- `permission_action` is the action of the `Permission`

 **See Also:**
["Enabling or Disabling Permissions"](#)

A.22 disable_permission

```
PROCEDURE disable_permission(key NUMBER)
```

Disables existing policy table row matching the specified key. The row remains in the table as an `INACTIVE` row. No error is reported if the key does not identify a row. The `disable_permission` procedure checks user permissions for policy table access and may throw a `SecurityException`.

 **See Also:**
["Enabling or Disabling Permissions"](#)

A.23 enable_permission

```
PROCEDURE enable_permission(key NUMBER)
```

Enables the existing policy table row matching the specified key. No error is reported if the key does not identify a row. The `enable_permission` procedure checks user permissions for policy table access and may throw a `SecurityException`.

 **See Also:**
["Enabling or Disabling Permissions"](#)

A.24 delete_permission

```
PROCEDURE delete_permission(key NUMBER)
```

Removes the existing policy table row matching the specified key. Before deleting the row, you must disable it as mentioned in ["disable_permission"](#). The `delete_permission` procedure has no effect if the row is still active or if `key` matches no rows.

 **See Also:**
["Enabling or Disabling Permissions"](#)

A.25 set_preference

```
PROCEDURE set_preference(user VARCHAR2, type VARCHAR2, abspath VARCHAR2, key
VARCHAR2, value VARCHAR2)
```

Inserts or updates a row in the SYS:java\$pref\$ table as follows:

```
CALL dbms_java.set_preference('HR', 'U', '/my/package/method/three', 'windowsize',
'22:32');
```

The `user` parameter specifies the name of the schema to which the preference should be attached. If the logged in schema is not SYS, then `user` must specify the current logged in schema or the INSERT will fail. The `type` parameter can take either the value U, indicating user preference, or S, indicating system preference. The `abspath` parameter specifies the absolute path for the preference. `key` is the preference key used for the lookup, and `value` is the value of the preference key.

A.26 runjava

```
FUNCTION runjava(cmdline VARCHAR2) RETURN VARCHAR2
```

Takes the Java command line as its only argument and runs it in Oracle JVM.



See Also:

["About Using the Command-Line Interface"](#)

A.27 runjava_in_current_session

```
FUNCTION runjava_in_current_session(cmdline VARCHAR2) RETURN VARCHAR2
```

Same as the `runjava` function, except that it does not clear Java state remaining from previous use of Java in the session, prior to executing the current command line.



See Also:

["About Using the Command-Line Interface"](#)

A.28 set_property

```
FUNCTION set_property(name VARCHAR2, value VARCHAR2) RETURN VARCHAR2
```

Establishes a value for a system property that is then used for the duration of the current RDBMS session, whenever a Java session is initialized.

 **Note:**

In order to execute the SET_PROPERTY function, a user must have write permission on SYS:java.util.PropertyPermission for the property name. You can grant this permission using the following command:

```
call dbms_java.grant_permission( '<user_name>',  
'SYS:java.util.PropertyPermission', '<property_name>', 'write' );
```

 **See Also:**

["About Setting System Properties"](#)

A.29 get_property

```
FUNCTION get_property(name VARCHAR2) RETURN VARCHAR2
```

Returns any value previously established by set_property.

 **See Also:**

["About Setting System Properties"](#)

A.30 remove_property

```
FUNCTION remove_property(name VARCHAR2) RETURN VARCHAR2
```

Removes any value previously established by set_property.

 **Note:**

In order to execute the remove_property function, a user must have write permission on SYS:java.util.PropertyPermission for the property name. You can grant this permission using the following command:

```
call dbms_java.grant_permission( '<user_name>',  
'SYS:java.util.PropertyPermission', '<property_name>', 'write' );
```

 **See Also:**

["About Setting System Properties"](#)

A.31 show_property

```
FUNCTION show_property(name VARCHAR2) RETURN VARCHAR2
```

Displays a message of the form `name = value` for the input name, or for all established property bindings, if name is null.



See Also:

["About Setting System Properties"](#)

A.32 set_output_to_sql

```
FUNCTION set_output_to_sql (id VARCHAR2,  
stmt VARCHAR2,  
bindings VARCHAR2,  
no_newline_stmt VARCHAR2 default null,  
no_newline_bindings VARCHAR2 default null,  
newline_only_stmt VARCHAR2 default null,  
newline_only_bindings VARCHAR2 default null,  
maximum_line_segment_length NUMBER default 0,  
allow_replace NUMBER default 1,  
from_stdout NUMBER default 1,  
from_stderr NUMBER default 1,  
include_newlines NUMBER default 0,  
eager NUMBER default 0) RETURN VARCHAR2
```

Defines a named output specification that constitutes an instruction for executing a SQL statement, whenever output to the default `System.out` and `System.err` streams occurs.

Valid commands for SQL statement arguments start with one of the following case-insensitive keywords, followed by a space or tab:

- SELECT
- INSERT
- DELETE
- UPDATE
- CALL



See Also:

["About Redirecting Output on the Server"](#)

A.33 remove_output_to_sql

```
FUNCTION remove_output_to_sql (id VARCHAR2) RETURN VARCHAR2
```

Deletes a specification created by `set_output_to_sql`.

**See Also:**

["About Redirecting Output on the Server"](#)

A.34 enable_output_to_sql

```
FUNCTION enable_output_to_sql (id VARCHAR2) RETURN VARCHAR2
```

Reenables a specification created by `set_output_to_sql` and subsequently disabled by `disable_output_to_sql`.

**See Also:**

["About Redirecting Output on the Server"](#)

A.35 disable_output_to_sql

```
FUNCTION disable_output_to_sql (id VARCHAR2) RETURN VARCHAR2
```

Disables a specification created by `set_output_to_sql`.

**See Also:**

["About Redirecting Output on the Server"](#)

A.36 query_output_to_sql

```
FUNCTION query_output_to_sql (id VARCHAR2) RETURN VARCHAR2
```

Returns a message describing a specification created by `set_output_to_sql`.

**See Also:**

["About Redirecting Output on the Server"](#)

A.37 set_output_to_java

```
FUNCTION set_output_to_java (id VARCHAR2,  
class_name VARCHAR2,  
class_schema VARCHAR2,
```

```
method VARCHAR2,  
bindings VARCHAR2,  
no_newline_method VARCHAR2 default null,  
no_newline_bindings VARCHAR2 default null,  
newline_only_method VARCHAR2 default null,  
newline_only_bindings VARCHAR2 default null,  
maximum_line_segment_length NUMBER default 0,  
allow_replace NUMBER default 1,  
from_stdout NUMBER default 1,  
from_stderr NUMBER default 1,  
include_newlines NUMBER default 0,  
eager NUMBER default 0,  
initialization_statement VARCHAR2 default null,  
finalization_statement VARCHAR2 default null)RETURN VARCHAR2
```

Defines a named output specification that constitutes an instruction for executing a Java method whenever output to the default `System.out` and `System.err` streams occurs.

Valid commands for SQL statement arguments start with one of the following case-insensitive keywords, followed by a space or tab:

- SELECT
- INSERT
- DELETE
- UPDATE
- CALL

**See Also:**

["About Redirecting Output on the Server"](#)

A.38 remove_output_to_java

```
FUNCTION remove_output_to_java (id VARCHAR2) RETURN VARCHAR2
```

Deletes a specification created by `set_output_to_java`.

**See Also:**

["About Redirecting Output on the Server"](#)

A.39 enable_output_to_java

```
FUNCTION enable_output_to_java (id VARCHAR2) RETURN VARCHAR2
```

Reenables a specification created by `set_output_to_java` and subsequently disabled by `disable_output_to_java`.

**See Also:**

["About Redirecting Output on the Server"](#)

A.40 disable_output_to_java

```
FUNCTION disable_output_to_java (id VARCHAR2) RETURN VARCHAR2
```

Disables a specification created by `set_output_to_java`.

**See Also:**

["About Redirecting Output on the Server"](#)

A.41 query_output_to_java

```
FUNCTION query_output_to_java (id VARCHAR2) RETURN VARCHAR2
```

Returns a message describing a specification created by `set_output_to_java`.

**See Also:**

["About Redirecting Output on the Server"](#)

A.42 set_output_to_file

```
FUNCTION set_output_to_file (id VARCHAR2,  
file_path VARCHAR2,  
allow_replace NUMBER default 1,  
from_stdout NUMBER default 1,  
from_stderr NUMBER default 1) RETURN VARCHAR2
```

Defines a named output specification that constitutes an instruction to capture any output sent to the default `System.out` and

`System.err` streams and append it to a specified file.

**See Also:**

["About Redirecting Output on the Server"](#)

A.43 remove_output_to_file

```
FUNCTION remove_output_to_file (id VARCHAR2) RETURN VARCHAR2
```

Deletes a specification created by `set_output_to_file`.



See Also:

["About Redirecting Output on the Server"](#)

A.44 enable_output_to_file

```
FUNCTION enable_output_to_file (id VARCHAR2) RETURN VARCHAR2
```

Reenables a specification created by `set_output_to_file` and subsequently disabled by `disable_output_to_file`.



See Also:

["About Redirecting Output on the Server"](#)

A.45 disable_output_to_file

```
FUNCTION disable_output_to_file (id VARCHAR2) RETURN VARCHAR2
```

Disables a specification created by `set_output_to_file`.



See Also:

["About Redirecting Output on the Server"](#)

A.46 query_output_to_file

```
FUNCTION query_output_to_file (id VARCHAR2) RETURN VARCHAR2
```

Returns a message describing a specification created by `set_output_to_file`.



See Also:

["About Redirecting Output on the Server"](#)

A.47 enable_output_to_trc

PROCEDURE enable_output_to_trc

Reenables printing the output to `System.out` and `System.err` in the `.trc` file that was disabled by the `disable_output_to_trc` procedure.



See Also:

["About Redirecting Output on the Server"](#)

A.48 disable_output_to_trc

PROCEDURE disable_output_to_trc

Prevents output to `System.out` and `System.err` from appearing in the `.trc` file.



See Also:

["About Redirecting Output on the Server"](#)

A.49 query_output_to_trc

FUNCTION query_output_to_trc RETURN VARCHAR2

Returns a value indicating whether printing output to `System.out` and `System.err` in the `.trc` file is currently enabled.



See Also:

["About Redirecting Output on the Server"](#)

A.50 endsession

FUNCTION endsession RETURN VARCHAR2

Clears any Java session state remaining from previous execution of Java in the current RDBMS session.

**See Also:**

["Two-Tier Duration for Java Session State"](#)

A.51 endsession_and_related_state

```
FUNCTION endsession_and_related_state RETURN VARCHAR2
```

Clears any Java session state remaining from previous execution of Java in the current RDBMS session and all supporting data related to running Java.

**See Also:**

["Two-Tier Duration for Java Session State"](#)

A.52 set_native_compiler_option

```
PROCEDURE set_native_compiler_option(optionName VARCHAR2,  
value VARCHAR2)
```

Sets a native-compiler option to the specified value for the current schema.

**See Also:**

["Oracle JVM Just-in-Time Compiler \(JIT\)"](#)

A.53 unset_native_compiler_option

```
PROCEDURE unset_native_compiler_option(optionName VARCHAR2,  
value VARCHAR2)
```

Unsets a native-compiler option/value pair for the current schema.

**See Also:**

["Oracle JVM Just-in-Time Compiler \(JIT\)"](#)

A.54 compile_class

```
FUNCTION compile_class(classname VARCHAR2) RETURN NUMBER
```

Compiles all methods defined by the class that is identified by *classname* in the current schema.

 **See Also:**

["Oracle JVM Just-in-Time Compiler \(JIT\)"](#)

A.55 uncompile_class

```
FUNCTION uncompile_class(classname VARCHAR2,  
permanentp NUMBER default 0) RETURN NUMBER
```

Uncompiles all methods defined by the class that is identified by *classname* in the current schema.

 **See Also:**

["Oracle JVM Just-in-Time Compiler \(JIT\)"](#)

A.56 compile_method

```
FUNCTION compile_method(classname VARCHAR2,  
methodname VARCHAR2,  
methodsig VARCHAR2) RETURN NUMBER
```

Compiles the method specified by *name* and *Java type* signatures defined by the class, which is identified by *classname* in the current schema.

 **See Also:**

["Oracle JVM Just-in-Time Compiler \(JIT\)"](#)

A.57 uncompile_method

```
FUNCTION uncompile_method(classname VARCHAR2,  
methodname VARCHAR2,  
methodsig VARCHAR2,  
permanentp NUMBER default 0) RETURN NUMBER
```

Uncompiles the method specified by the *name* and *Java type* signatures defined by the class that is identified by *classname* in the current schema.

 **See Also:**

["Oracle JVM Just-in-Time Compiler \(JIT\)"](#)

A.58 start_jmx_agent

```
PROCEDURE start_jmx_agent(port VARCHAR2 default NULL,  
ssl VARCHAR2 default NULL,  
auth VARCHAR2 default NULL)
```

Starts the JMX agent in a specific session. Generally, the agent remains active for the duration of the session.



See Also:

["Managing Your Applications Using JMX"](#)

A.59 set_runtime_exec_credentials

```
PROCEDURE set_runtime_exec_credentials(dbuser VARCHAR2,  
osuser VARCHAR2,  
ospass VARCHAR2)
```

where, `dbuser` is the name of a database user or a schema name and `osuser`, `ospass` are OS account credentials.

Associates the database user/schema `dbuser` with the `osuser/ospass` operating system (OS) credential pair. This association is encrypted and stored in a table owned by the `SYS` user. Once the new and valid association is established, every new OS process forked by the `java.lang.Runtime.exec` methods or every `ProcessBuilder` invoked by `dbuser` to run an OS command runs as the UID `osuser`, and not as the OS ID of the Oracle process. That is, the UID bits of the forked process are set to UID `osuser`.



Note:

DBAs and security administrators can use this procedure to tighten security of Java applications deployed to Oracle Database. By specifying lesser-privileged accounts, a DBA can limit the power and access rights of spawned processes as appropriate. You must be the `SYS` user to use the `set_runtime_exec_credentials` procedure, otherwise the `ORA-01031: insufficient privileges` error is raised. Use of invalid account credentials results in an `IOException`, when a new process is created.

Following examples show how to use this procedure:

Example 1

The following command binds user/schema `DBUSER` to credentials `osuser/ospass`:

```
dbms_java.set_runtime_exec_credentials('DBUSER', 'osuser', 'ospass');
```

Example 2

Either of the following commands unbinds the association of DBUSER and credentials osuser/ospass:

```
dbms_java.set_runtime_exec_credentials('DBUSER', '', '');
```

```
dbms_java.set_runtime_exec_credentials('DBUSER', null, null);
```

Note:

To use the `set_runtime_exec_credentials` procedure, you must configure the Oracle `jssu` facility to `setuid root` during oracle product installation, otherwise the process spawn via `jssu` failed... `IOException` may be raised at process creation time.

See Also:

["Secure Use of Runtime.exec Functionality in Oracle Database"](#)

B

DBMS_JAVASCRIPT Package

The `DBMS_JAVASCRIPT` package provides a PL/SQL procedure for running DBMS-residing JavaScript code from location identified by its argument.

This chapter contains the following topics:

- [DBMS_JAVASCRIPT Overview](#)
- [DBMS_JAVASCRIPT Security Model](#)

B.1 DBMS_JAVASCRIPT Overview

The `DBMS_JAVASCRIPT` package is `AUTHID CURRENT_USER` package and provides a single procedure `RUN`, for running JavaScript code. RDBMS users maintain their JavaScript code in RDBMS as Java resource objects stored in their respective schemas.

You can create scripts in your schemas in either of the following two ways:

- Using the `loadjava` tool or calling the `dbms_java.loadjava` procedure
- Using `CREATE [OR REPLACE] JAVA RESOURCE` command

B.1.1 The RUN Procedure

This procedure invokes Java code that locates a Java resource with its name provided as the `script_name` argument. It then submits its content for syntax and semantic analysis, compilation, and evaluation by the Nashorn JavaScript compiler and runtime engine.

Prior to execution, Nashorn code is compiled to Java bytecodes.

Syntax

```
procedure run(script_name varchar2);
```

You can call this procedure in the following way:

```
call dbms_javascript.run('my_script.js');
```

 **Note:**

- To run this procedure, you must have the `DBJAVASCRIPT` role granted.
- The `DBMS_JAVASCRIPT.RUN` procedure does not run the text of JavaScript and does not look for scripts in the file system. A Java resource name is the only valid input for this procedure.

B.2 DBMS_JAVASCRIPT Security Model

In order to be able to run JavaScript code, RDBMS users must be granted the role `DBJAVASCRIPT`.

The argument to the `DBMS_JAVASCRIPT.RUN` procedure must be a string identifying a valid Java resource that was previously loaded into the user's own schema. The procedure rejects the following arguments among others:

- Open-coded scripts
- File paths
- URLs

These restrictions are important to prevent the users from writing PL/SQL code, which builds scripts from fragments that may become implicated in JavaScript injection attacks. The scripting mode extensions of Nashorn engine invoked by the `DBMS_JAVASCRIPT.RUN` procedure are unconditionally disabled and no one including the `SYS` user can run them. The engine instantiation and use are dependent on the `oracle.DbmsJavaScriptUser` permission grant. Also, all the Nashorn-related APIs are in the restricted package space of Oracle JVM, and class filtering is applied unconditionally when scripts attempt to load Java classes. The class filtering achieves the following:

- Rejects any class that fails the Java package access checks as governed by `SecurityManager`
- Unconditionally restricts the packages `java.security`, `java.lang.reflect`, and `oracle.aurora.rdbms.security` for loading by any user

The `DBJAVASCRIPT` role is used by DBAs to administer JavaScript usage in the database. The role is granted a sole grant, which is a `oracle.DbmsJavaScriptUser` permission.

C

Classpath Extensions and User Classloaded Metadata

This section provides a description of the extensions to the `-classpath` search path and User Classloaded Metadata.

C.1 Classpath Extensions

This section provides a description of the extensions to the `-classpath` search path and `jserver` URL protocol syntaxes that allow specification of database resident objects and byte sets in search paths used by the command-line interface.

C.1.1 `jserverQuotedClassPathTermPrefix`

When a classpath term begins with the `jserverQuotedClassPathTermPrefix` string, it extends through the next occurrence of the string, regardless of the `File.pathSeparator` characters it may contain. The actual value of this string is given by the system property `jserver.quoted.classpath.term.prefix`. If this property is not defined, the default value is `| |`.

C.1.2 `jserverURLPrefix`

When a dequoted classpath term begins with the `jserverURLPrefix` string, the rest of the term is treated as a URL. The value of this string is given by the system property `jserver.url.in.classpath.prefix`. If this value is null, any quoted term that does not begin with one of the following three prefixes, is treated as a URL:

- `jserverSpecialTokenPrefix`, if the value is set
- `JSERVER_CP`
- `JSERVER_SCHEMAC`

Note:

A quoted term is one that begins and ends with the string that is the value of `jserverQuotedClassPathTermPrefix`. A dequoted term is either the whole original term if it is not quoted, or the part of a quoted term between the beginning and ending occurrences of `jserverQuotedClassPathTermPrefix`.

C.1.3 `jserverSpecialTokenPrefix`

The value of the `jserverSpecialTokenPrefix` string is given by the system property `jserver.specialtoken.in.classpath.prefix`. If this value is not null, then the

prefixes `JSERVER_CP` and `JSERVER_SCHEMAC` are recognized only when preceded by this string.

Related Topics

- [JSERVER_CP](#)
- [JSERVER_SCHEMAC](#)

C.1.4 JSERVER_CP

A classpath term beginning with the literal substring "JSERVER_CP" is converted to a URL by replacing `JSERVER_CP` with `jserver:/CP`.

C.1.5 JSERVER_SCHEMAC

A classpath term beginning with the literal substring "JSERVER_SCHEMAC" is converted to a URL by replacing `JSERVER_SCHEMAC` with `jserver:/CPcSCHEMAC`. Here `c` can be any character, but is typically `/`. This means that a term of the form `JSERVER_SCHEMAC` + `<remaining string>` is treated as a prescription for looking for shared System classloaded classes and resources in the schema identified by `<remaining string>`. For example, the term `JSERVER_SCHEMA/HR` is equivalent to `jserver:/CP/SCHEMA/HR` and it instructs to look for shared classes and resources in the schema named `HR`.

C.1.6 jserver:/CP general syntax

A URL beginning with `jserver:/CP` is meaningful only as a classpath term. The first character following `jserver:/CP` is used as the token separator for the remainder of the string. This is typically the character `/`. The subsequent tokens are the following:

- The possible values of the first token are `JAR`, `RESOURCE`, or `SHARED_DATA`, where `RESOURCE` indicates a Java resource object, `SHARED_DATA` indicates a Java shared data object, and `JAR` indicates a database resident JAR object. This token is optional and all of the values are case-insensitive. If one of these is present, the URL is called a JAR specifier. Otherwise, it is called a SCHEMA specifier.
- The value of the second token is `PRIVATE`. This is an optional token and is case-insensitive.
- The value of the third token is `SCHEMA`. This is a required token and is case-insensitive.
- The fourth token is a required token, which is interpreted as a schema name.
- The fifth token is required for a JAR specifier and prohibited for a SCHEMA specifier. It is interpreted as the name of an object in the schema identified by the fourth token, if present.

Functionally, a classpath term is used to look for an object that matches a class or resource name that is being searched for. In the case of a SCHEMA specifier, the object is looked for in the indicated schema. In the case of a JAR specifier, a particular object in the schema is identified by the fifth token in the URL. This object is treated as a JAR and the searched for object is looked for by name, within that JAR. In the case of looking for a class within a database resident JAR, this may mean finding the class as a class object in the schema. Otherwise, it means finding the search object in the actual bytes of the JAR object.

The searched for object is a database Java class object, if it meets the following conditions:

- The search name ends in `.class`
- the URL is either a SCHEMA specifier or a JAR specifier for a database resident JAR

Such a class object may be:

- Loaded as a shared system classloaded class. This is done if the optional second token `PRIVATE` is not present.
- Interpreted as a set of bytecodes and loaded by the `defineClass` method as a private user classloaded class. This is done if the optional second token `PRIVATE` is present.

 **Note:**

Classes loaded from classpath terms not beginning with the jserver URL marker are always private, user classloaded classes.

C.2 User Classloaded Metadata

Starting from 11g release 1 (11.1), there is a new system table created in the following manner in `javavm/install/initjvma.sql` during database creation and upgrade:

```
create table java$jvm$runtime$parameters (owner# number not null,flags number);
create unique index java$jvm$runtime$parameters$i on
java$jvm$runtime$parameters(owner#);
```

This table is removed during downgrade by `javavm/install/rmjvm.sql`. If you want to share private class metadata and have DBA privileges, then you can populate this table manually. The rule is that if there is a row matching your owner ID, then the flag value of this row is bitwise anded with the flag value from the row with `owner# = -1`, if any. If none of these previously mentioned rows exist, then the bit set in the result is `-1`, that is, all bits set. If bit 0 (`1<<0`) is set in the result, then your session attempts to share existing shared private metadata. If bit 1 (`1<<1`) is set in the result, then the session creates shared metadata when existing shared metadata is not found. By default, there is no row in the table. So, all sessions both use and create shared private metadata.

Index

Symbols

.class files, [2-4](#), [2-16](#)
.java files, [2-4](#), [2-16](#)
.properties files, [2-4](#)
.ser files, [2-4](#)
.sqlj files, [2-4](#), [2-16](#)

A

act method, [2-58](#), [2-59](#)
application
 compiling, [2-6](#)
 developing, [9-1](#)
 development, [2-1](#)
 executing in a session, [2-1](#)
 execution control, [2-3](#)
 execution rights, [2-19](#)
 invoking, [3-1](#)
 running on the server, [3-12](#)
 threading, [2-54](#)
attributes, [6-2](#), [7-13](#)
 declaring, [7-14](#)
authentication, [11-1](#)
 mechanisms, [11-22](#)
AUTHID clause, [7-7](#), [7-11](#), [7-14](#)

B

BasicPermission, [11-10](#)
body
 package, [7-11](#)
 SQL object type, [7-13](#)
bytecode
 defined, [1-6](#)
 definition, [1-20](#)
 verifier, [2-13](#)

C

call
 definition, [1-16](#)
 managing resources across calls, [2-62](#)
call memory, [2-3](#)

call specification, [3-1](#), [7-1](#)
 defining, [7-2](#)
 mapping data types, [7-3](#)
 object type, [7-13](#)
 packaged, [7-11](#)
 top-level, [7-7](#)
Callback class
 act method, [2-58](#)
calss
 loader, [1-20](#)
class
 auditing, [2-24](#)
 definition, [1-2](#)
 dynamic loading, [1-15](#)
 execution, [2-3](#)
 fields, [1-2](#)
 hierarchy, [1-8](#)
 inheritance, [1-8](#)
 interpretation, [2-3](#)
 loading, [2-3](#), [2-15](#)
 loading permission, [11-20](#)
 marking valid, [2-11](#)
 methods, [1-2](#)
 name, [2-26](#)
 publish, [2-24](#), [7-1](#)
 resolving dependencies, [2-11](#)
 resolving reference, [2-11](#)
 schema object, [2-3](#), [2-11](#), [2-16](#)
 shortened name, [2-26](#)
 single inheritance, [1-3](#)
Class interface
 forName method, [2-27](#)
class schema object, [2-16](#), [13-1](#), [13-3](#)
Class.forName
 lookupClass method, [2-29](#)
class.forNameAndSchema method, [2-29](#)
client
 install JDK, [4-3](#)
 set up environment variables, [4-3](#)
 setup, [4-3](#)
compiling, [1-20](#), [2-5](#)
 error messages, [2-7](#), [13-4](#)
 options, [2-7](#), [13-4](#)
 run time, [2-6](#), [2-7](#)

configuration, [4-1](#)
 JVM, [4-2](#)
 performance, [10-4](#)

connection
 security, [11-1](#)

constructor methods, [7-15](#)

context
 run-time, [6-1](#)
 stored procedures, [6-1](#)

CREATE JAVA statement, [6-5](#)

D

data confidentiality, [11-1](#)

data types
 mapping, [7-3](#)

database
 privileges, [11-2](#)
 schema plan, [9-1](#)
 trigger, [8-4](#)
 triggers, [6-2](#)

database triggers
 calling Java, [8-4](#)

DBA_JAVA_POLICY view, [11-14](#)

DBMS_JAVA package, [4-2](#), [8-1](#)
 compile_class, [A-18](#)
 compile_method, [A-19](#)
 delete_permission method, [11-14](#), [A-9](#)
 derivedFrom method, [A-2](#)
 disable_output_to_file, [A-16](#)
 disable_output_to_java, [A-15](#)
 disable_output_to_sql, [A-13](#)
 disable_output_to_trc, [A-17](#)
 disable_permission method, [11-14](#), [A-9](#)
 dropjava method, [A-5](#)
 enable_output_to_file, [A-16](#)
 enable_output_to_java, [A-14](#)
 enable_output_to_sql, [A-13](#)
 enable_output_to_trc, [A-17](#)
 enable_permission method, [11-14](#), [A-9](#)
 endsession, [A-17](#)
 endsession_and_related_state, [A-18](#)
 export_class method, [A-4](#)
 export_resource method, [A-4](#)
 export_source method, [A-4](#)
 fixed_in_instance method, [A-3](#)
 get property, [A-11](#)
 get_compiler_option method, [A-1](#)
 grant_permission method, [11-6](#), [A-5](#), [A-6](#)
 grant_policy_permission method, [11-9](#),
 [11-11](#), [A-7](#), [A-8](#)
 loadjava method, [A-4](#)
 longname method, [2-22](#), [2-26](#), [A-1](#)
 modifying permissions, [11-14](#)

DBMS_JAVA package (*continued*)
 modifying PolicyTable permissions, [11-6](#),
 [11-9](#)

 query_output_to_file, [A-16](#)
 query_output_to_sql, [A-13](#)
 query_output_to_trc, [A-17](#)
 remove property, [A-11](#)
 remove_output_to_file, [A-16](#)
 remove_output_to_java, [A-14](#)
 remove_output_to_sql, [A-12](#)
 reset_compiler_option method, [A-2](#)
 resolver method, [A-2](#)
 restrict_permission method, [11-7](#), [A-6](#), [A-7](#)
 revoke_permission method, [11-14](#), [A-8](#)
 runjava, [A-10](#)
 runjava_in_current_session, [A-10](#)
 set property, [A-10](#)
 set_compiler_option method, [A-2](#)
 set_native_compiler_option, [A-18](#)
 set_output method, [A-3](#)
 set_output_to_file, [A-15](#)
 set_output_to_java, [A-13](#)
 set_output_to_sql, [A-12](#)
 set_preference method, [A-10](#)
 setting permissions, [11-4](#)
 shortname method, [2-23](#), [2-26](#), [A-1](#)
 show property, [A-12](#)
 start_jmx_agent, [A-20](#)
 uncompile_class, [A-19](#)
 uncompile_method, [A-19](#)
 unset_native_compiler_option, [A-18](#)

DBMS_JAVA query_output_to_java, [A-15](#)

DBMS_OUTPUT package, [A-3](#)

DbmsJava class see DBMS_JAVA package, [4-2](#)

deadlock, [2-55](#)

DeadlockError exception, [2-55](#)

debugging
 Java stored procedures, [6-7](#)
 permissions, [11-20](#)

default java.security resource, [11-21](#)

definer rights, [2-20](#)

delete method, [11-14](#)

delete_permission method, [A-9](#)

derivedFrom method, [A-2](#)

DETERMINISTIC hint, [7-8](#)

Directory Context, [12-3](#)

disable method, [11-14](#)

disable_permission method, [A-9](#)

dropjava method, [A-5](#)

dropjava tool, [2-17](#), [13-19](#)

E

ease of use, [6-3](#)

echo command, [13-26](#)

enable method, [11-14](#)
 enable_permission method, [A-9](#)
 encapsulation, [1-4](#)
 end-of-call Migration, [2-57](#)
 EndOfCallRegistry class
 registerCallback method, [2-58](#)
 errors
 compilation, [2-7](#)
 exception
 DeadlockError, [2-55](#)
 how Oracle JVM handles, [8-10](#)
 LimboError, [2-55](#)
 exit command, [13-26](#)
 exitCall method, [2-55](#)
 export_class method, [A-4](#)
 export_resource method, [A-4](#)
 export_source method, [A-4](#)

F

fields
 definition, [1-2](#)
 types of, [1-2](#)
 file names
 dropjava tool, [13-21](#)
 loadjava tool, [13-13](#)
 files, [2-31](#)
 lifetime, [2-62](#)
 finalizers, [2-33](#)
 fixed_in_instance method, [A-3](#)
 footprint, [1-12](#), [2-2](#)
 foreign key, [9-2](#)
 forName method, [2-27](#)
 full name, Java, [2-5](#)
 functions, [6-2](#)

G

garbage collection, [2-3](#)
 managing resources, [2-31](#)
 misuse, [2-32](#)
 garbage collectioin
 purpose, [2-32](#)
 get_compiler_option method, [2-8](#), [A-1](#)
 grant method, [11-7](#)
 grant_permission method, [11-6](#), [A-5](#), [A-6](#)
 grant_policy_permission method, [11-9](#), [A-7](#), [A-8](#)
 granting permissions, [11-4](#)
 grantPolicyPermission method, [11-9](#)
 graphical user interface see GUI, [1-17](#)
 GUI, [1-17](#), [2-25](#)

H

help command, [13-26](#)

I

inheritance, [1-3](#)
 installation, [4-1](#)
 integrated development environment (IDE), [1-17](#)
 integrity, [11-1](#)
 interface, [1-3](#)
 internal JDBC driver, [1-20](#)
 interoperability, [6-4](#)
 interpreter, [1-20](#)

J

J2SE

 install, [4-3](#)

Java

 applications, [2-1](#), [2-15](#)
 calling from database triggers, [8-4](#)
 calling from PL/SQL, [8-8](#)
 calling from SQL DML, [8-7](#)
 calling from the top level, [8-1](#)
 calling restrictions, [8-7](#)
 checking loaded classes, [2-22](#)
 classes, [1-2](#)
 client setup, [4-2](#)
 compiling, [2-6](#)
 development environment, [2-3](#)
 development tools, [1-24](#)
 execution control, [2-3](#)
 execution in database, [6-1](#)
 execution rights, [2-19](#)
 fields, [1-2](#)
 full name, [2-5](#)
 in the database, [1-9](#), [2-1](#)
 invoking, [3-1](#)
 key features, [1-5](#)
 loading applications, [2-15](#)
 loading classes, [2-3](#)
 methods, [1-2](#)
 overview, [1-1](#)
 polymorphism, [1-4](#)
 publishing, [2-3](#), [7-1](#)
 resolving classes, [2-11](#)
 short name, [2-5](#)
 stored procedures see stored procedures, [8-1](#)

Java audit

 object level, [2-25](#)
 statement level, [2-24](#)

java command, [13-26](#)

Java Compatibility Kit see JCK, [1-8](#)

Java Database Connectivity see JDBC, [1-6](#)

Java Development Kit see JDK, [4-3](#)

java interpreter, [2-3](#)

Java Language Specification see JLS, [1-2](#)

Java Naming and Directory Interface see JNDI, [1-6](#)

Java Native Interface see JNI, [3-3](#)

Java session initialization, duration and
entrypoints, [1-16](#)

Java stored procedures see stored procedures,
[8-1](#)

Java virtual machine see JVM, [1-6](#)

JAVA_ADMIN
granting permission, [11-2](#), [11-4](#), [11-9](#), [11-15](#)

JAVA_ADMIN example, [11-10](#)

java_jit_enabled, [10-1](#)

JAVA_SOFT_SESSIONSPACE_LIMIT
parameter, [10-4](#)

JAVA\$OPTIONS table, [2-7](#)

Java2
security, [11-2](#)

Java2 Platform, Standard Edition see Java SE,
[4-3](#)

JAVADEBUGPRIV role, [11-17](#)

JAVASYSPRIV role, [11-17](#)

JAVAUSERPRIV role, [11-17](#)

JCK, [1-8](#)

JDBC, [1-6](#), [10-1](#)
accessing SQL, [1-23](#)
defined, [3-3](#)
driver, [1-19](#)
driver types, [1-23](#), [3-4](#)
drivers, [1-23](#)
example, [3-6](#)
security, [11-1](#)
server-side internal driver, [1-20](#)

JDeveloper
development environment, [1-24](#)

JDK
install, [4-3](#)

JIT
advantages, [10-2](#)
overview, [10-1](#)

JLS, [1-2](#), [1-7](#)

JNDI, [1-6](#)

JNDI support
overview, [12-1](#)
requirements, [12-1](#)
Namespace, [12-1](#)
namespace browser, [12-5](#)
Oracle Java Directory Service JNDI
Name Space Provider, [12-3](#)

JNI
support, [3-3](#)

Just-in-Time Compiler see JIT, [10-1](#)

JVM, [1-6](#)
bytecode, [1-6](#)
configure, [4-1](#)

JVM (*continued*)
defined, [1-1](#)
garbage collection, [1-10](#), [1-11](#)
install, [4-1](#)
multithreading, [1-10](#)
responsibilities, [2-2](#)

K

key
foreign, [9-2](#)
primary, [9-2](#)

L

library manager, [1-19](#)

LimboError exception, [2-55](#)

loader, class, [1-20](#)

loading, [2-15](#)
checking results, [2-17](#), [2-22](#)
class, [1-15](#), [2-3](#), [2-5](#), [2-15](#)
compilation option, [2-6](#)
granting execution, [2-19](#)
reloading classes, [2-19](#)
restrictions, [2-17](#)

loadjava method, [A-4](#)

loadjava tool, [2-15](#)
compiling source, [2-7](#), [10-8](#)
example, [3-2](#), [6-6](#)
execution rights, [2-19](#), [11-2](#)
loading class, [2-15](#)
resolution modes, [13-3](#)
using memory, [10-4](#)

logging, [2-14](#)

LogManager, [2-14](#)

longname method, [2-26](#), [A-1](#)

lookupClass method, [2-29](#)

M

main method, [2-3](#)

maintainability, [6-4](#)

map methods, [7-15](#)

memory
across calls, [2-32](#)
call, [2-3](#)
Java pool, [10-6](#)
leaks, [2-32](#)
lifetime, [2-31](#), [2-62](#)
performance configuration, [10-4](#)
session, [2-3](#)

methods, [1-2](#), [6-2](#), [7-13](#)
constructor, [7-15](#)
declaring, [7-14](#)

methods (*continued*)
 map and order, [7-15](#)
 object-relational, [6-2](#)
 missing classes, [13-10](#)
 modes
 parameter, [7-3](#)
 multiple inheritance, [1-3](#)
 multithreading, [1-10](#)

N

NAME clause, [7-8](#)
 namespace, [13-23](#)
 native compilation
 methods, [1-13](#)
 performance, [1-13](#)
 native Java interface, [3-10](#)

O

object, [1-2](#)
 full to short name conversion, [2-22](#)
 lifetime, [2-62](#)
 schema, [2-3](#)
 serialization, [2-30](#)
 SQL type, [6-2](#)
 table, [7-16](#)
 writing call specifications, [7-13](#)
 object-relational methods, [6-2](#)
 ObjectFactories, [12-4](#)
 OJDS, [12-1](#)
 APIs and classes, [12-14](#)
 command-line tools, [12-6](#)
 bind, [12-11](#)
 binddds, [12-12](#)
 bindurl, [12-13](#)
 cd, [12-7](#)
 chmod, [12-10](#)
 chown, [12-8](#)
 ln, [12-9](#)
 ls, [12-6](#)
 mkdir, [12-8](#)
 mv, [12-10](#)
 pwd, [12-7](#)
 rm, [12-9](#)
 OJDS URL Support, [12-4](#)
 ojvmjava tool, [13-23](#)
 operating system
 resources, [2-31](#)
 operating system resources
 access, [2-31](#)
 across calls, [2-63](#)
 closing, [2-32](#)
 garbage collection, [2-32](#)
 lifetime, [2-31](#)

operating system resources (*continued*)
 managing, [2-31](#)
 overview, [2-31](#)
 performance, [10-4](#)
 Oracle Java Directory Service, [12-1](#)
 Oracle JVM
 class loader, [1-20](#)
 compiler, [1-20](#)
 configuration requirements, [4-2](#)
 interpreter, [1-20](#)
 JDBC internal driver, [1-20](#)
 library manager, [1-19](#)
 main components, [1-18](#)
 SQLJ translator, [1-21](#)
 verifier, [1-20](#)
 Oracle Net Services Connection Manager, [1-9](#)
 oracle.aurora.jndi.ojds.OjdsClientContext, [12-14](#)
 oracle.aurora.jndi.ojds.OjdsInitialContextFactory, [12-15](#)
 oracle.aurora.jndi.ojds.OjdsServerContext, [12-15](#)
 oracle.aurora.jndi.ojds.OjdsURLContext, [12-16](#)
 oracle.aurora.jndi.ojds.OjdsURLContextFactory, [12-16](#)
 order methods, [7-15](#)
 output
 redirecting, [3-12](#), [8-1](#)

P

package DBMS_JAVA, [4-2](#), [8-1](#)
 packaged call specifications, writing, [7-11](#)
 PARALLEL_ENABLE option, [7-8](#)
 parameter modes, [7-3](#)
 performance, [6-3](#), [10-1](#)
 native compilation, [1-13](#)
 permission
 Oracle-specific, [11-15](#)
 types, [11-14](#)
 Permission class, [11-5](#), [11-6](#), [11-10](#)
 permissions, [11-1](#)
 administrating, [11-9](#)
 assigning, [11-3](#), [11-4](#)
 debugging, [11-20](#)
 deleting, [11-14](#)
 granting, [11-4](#), [11-6](#)
 granting policy, [11-9](#)
 granting, example, [11-6](#)
 grouped into roles, [11-19](#)
 JAVADEBUGPRIV role, [11-17](#)
 JAVASYSPRIV role, [11-17](#)
 JAVAUSERPRIV role, [11-17](#)
 limiting, [11-4](#), [11-7](#)
 limiting, example, [11-6](#)
 PUBLIC, [11-17](#)
 restricting, [11-4](#), [11-7](#)

permissions (*continued*)
 restricting, example, [11-6](#)
 specifying policy, [11-3](#)
 SYS permission, [11-17](#)
 types, [11-14](#)

PL/SQL
 calling Java from, [8-8](#)
 packages, [7-11](#)

policy table
 managing, [11-9](#)
 modifying, [11-4](#)
 setting permissions, [11-4](#)
 viewing, [11-4](#)

PolicyTable class
 updating, [11-4](#)

PolicyTableManager class
 delete method, [11-14](#)
 disable method, [11-14](#)
 enable method, [11-14](#)

polymorphism, [1-4](#)

primary key, [9-2](#)

privileges
 database, [11-2](#)

procedures, [6-2](#)

productivity, [6-3](#)

PUBLIC permissions, [11-17](#)

publishing, [2-3](#), [2-5](#), [2-24](#)
 example, [3-2](#), [6-6](#)

R

redirecting output, [3-12](#), [8-1](#)

registerCallback method, [2-58](#)

replication, [6-4](#)

reset_compiler_option method, [2-8](#), [A-2](#)

resolver, [2-11](#), [13-2](#), [13-3](#)

default, [2-11](#)

defined, [2-4](#), [2-5](#), [2-27](#)

example, [3-2](#), [6-6](#)

ignoring non-existent references, [2-11](#), [2-13](#)

resolver method, [A-2](#)

resolver specification

definition, [2-11](#)

resource schema object, [2-16](#), [2-17](#), [13-1](#)

restrict method, [11-7](#)

restrict_permission method, [11-6](#), [11-7](#), [A-6](#), [A-7](#)

revoke method, [11-14](#)

revoke_permission method, [11-14](#), [A-8](#)

row trigger, [8-4](#)

run-time contexts, stored procedures, [6-1](#)

Runtime.exec, [2-33](#)

S

scalability, [6-4](#)

scavenging, [1-11](#)

security, [6-4](#)

session, [1-15](#)

namespace, [13-23](#)

session memory, [2-3](#)

set_compiler_option method, [2-8](#), [A-2](#)

set_output method, [A-3](#)

set_preference method, [A-10](#)

SHARED_POOL_SIZE parameter, [10-4](#)

shell commands, [13-26](#)

short name, Java, [2-5](#)

shortname method, [A-1](#)

single inheritance, [1-3](#)

source schema object, [2-16](#), [13-1](#)

SQLJ

server-side translator, [1-21](#)

translator, [1-21](#)

start_jmx_agent, [A-20](#)

StateFactories, [12-4](#)

statement trigger, [8-4](#)

stored procedures

advantages, [6-3](#)

calling, [8-1](#)

defined, [1-22](#)

developing, [6-1](#), [9-1](#)

example, [9-1](#)

introduction, [6-1](#)

invoking, [3-1](#)

publishing, [7-1](#)

steps, [6-5](#)

T

threading

model, [1-10](#), [2-54](#)

threads

across calls, [2-62](#)

Oracle JVM, [2-32](#)

threading in Oracle Database, [2-54](#)

top-level call specifications, writing, [7-7](#)

triggers

calling Java from, [8-4](#)

database, [6-2](#), [8-4](#)

row, [8-4](#)

statement, [8-4](#)

using Java stored procedures, [3-1](#), [6-5](#)

U

user interface, [2-25](#)

USER_JAVA_POLICY view, [11-14](#)

USER_OBJECTS

accessing, example, [2-22](#)

V

V\$SGASTAT table, [10-7](#)

variables

 static, [2-3](#)

verifier, [1-20](#)

version

 retrieving, [3-12](#)

version command, [13-26](#)

W

Web services

 call-outs from database, [14-7](#)

 Oracle Database features, [14-8](#)

 overview, [14-1](#)

 service consumer, [14-1](#)